

# **TRACKER**

**OFF ROAD**

## OPERATOR'S MANUAL



**⚠ WARNING**

The removal or modification of evaporative emission-related parts on this OHRV is illegal. Violators may be subject to civil and/or criminal penalties as provided under California and federal law.

p/n: 2263-698

06/23 Rev. A

**800SX**



## **This vehicle can be hazardous to operate.**

A collision or rollover can occur quickly, even during what you think are routine maneuvers such as driving or turning on flat terrain, driving on hills, or crossing obstacles, if you fail to take proper precautions. For your safety, understand and follow all the warnings contained in this Operator's Manual and on the labels on this vehicle.

Keep this Operator's Manual with this vehicle at all times. If you lose your manual, contact the manufacturer for a free replacement. The labels should be considered permanent parts of the vehicle. If a label comes off or becomes hard to read, contact an authorized dealer for a free replacement. Contact the manufacturer for proper registration information.

**FAILURE TO FOLLOW THE WARNINGS CONTAINED IN THIS MANUAL CAN RESULT IN SERIOUS INJURY OR DEATH.**

Particularly important information is distinguished in this manual by the following notations:

	The Safety Alert Symbol means <b>ATTENTION! BE ALERT! YOUR SAFETY IS INVOLVED.</b>
	<b>WARNING</b> indicates a hazardous situation which, if not avoided, could result in death or serious injury.
	<b>CAUTION</b> , without the safety alert symbol, is used to address practices not related to personal injury.
<b>■ NOTE:</b>	A <b>NOTE</b> provides key information to make procedures easier or more clear.

## **FREE ROV SAFETY TRAINING**

Free training is available for Recreational Off-Highway Vehicle (ROV) operators and passengers from the Recreational Off-Highway Vehicle Association (ROHVA). The manufacturer recommends that you complete this course before you first use your new ROV.

This online course takes approximately two hours to complete and presents you with a certificate of accomplishment as soon as you complete the course. The course does not have to be completed all at one time. It will remember where you left off and bring you back to that point when you return.

**ALWAYS USE COMMON SENSE WHEN OPERATING THIS VEHICLE.**

Visit [www.ROHVA.org](http://www.ROHVA.org) to start your training.

## **California Proposition 65**

	<b>WARNING</b>
<b>The Engine Exhaust from this product contains chemicals known to the State of California to cause cancer, birth defects or other reproductive harm.</b>	

# Foreword

Congratulations and thank you for purchasing a TRACKER OFF ROAD™ vehicle. Built with American engineering and manufacturing know-how, it is designed to provide superior ride, comfort, utility, and dependable service.

This Operator's Manual is furnished to ensure that the operator is aware of safe operating procedures. It also includes information about the general care and maintenance of this vehicle.

Carefully read the following pages. If you have any questions regarding this vehicle, contact an authorized dealer for assistance. Remember, only authorized dealers have the knowledge and facilities to provide you with the best service possible.

## Protect Your Sport

- Become familiar with all local and state/provincial laws governing ROV operation,
- Respect your vehicle,
- Respect the environment, and
- Respect private property and do not trespass.

The manufacturer advises you to strictly follow the recommended maintenance program as outlined. This preventive maintenance program is designed to ensure that all critical components on this vehicle are thoroughly inspected at various intervals.

All information in this manual is based on the latest product data and specifications available at the time of printing. The manufacturer reserves the right to make product changes and improvements which may affect illustrations or explanations without notice.

You have chosen a quality product designed and manufactured to give dependable service. Be sure, as the owner/operator of this vehicle, to become thoroughly familiar with its basic operation, maintenance, and storage procedures.

Read and understand the entire Operator's Manual before operating this vehicle to ensure safe and proper use. Always operate the vehicle within your level of skill and current terrain conditions.

Division II of this manual covers operator-related maintenance, operating instructions, and storage instructions. If major repair or service is ever required, contact an authorized dealer for professional service.

At the time of publication, all information and illustrations in this manual were technically correct. Some illustrations used in this manual are used for clarity purposes only and are not designed to depict actual conditions. Because the manufacturer constantly refines and improves its products, no retroactive obligation is incurred.

## Parts and Accessories

When in need of replacement parts, oil, or accessories for this vehicle, be sure to use only GENUINE PARTS, OIL, AND ACCESSORIES. **Only genuine parts, oil, and accessories are engineered to meet the standards and requirements of this vehicle. For a complete list of accessories, refer to the current ROV Accessory Catalog.**

To aid in service and maintenance procedures on this vehicle, a Service Manual and an Illustrated Parts Manual are available through an authorized dealer.

Operation of this vehicle is restricted to people 16 years of age and older who possess a valid driver's license. Passengers must be able to place both feet flat on the floor while keeping their back against the seat and holding on to an available handhold.

# Table of Contents

Foreword .....	1	<b>General Maintenance.....</b>	<b>41-62</b>
Parts and Accessories .....	1	Maintenance Schedule.....	42
<b>Division I — Safety</b>		Liquid Cooling System.....	43
Safety Alert.....	4	Shock Absorbers .....	44
Hangtags .....	5-6	General Lubrication .....	45
Important Safety Information .....	7	Hydraulic Brake .....	47
Warning Labels .....	8-9	Fuel Hoses .....	48
Location of Parts and Controls .....	10	Protective Rubber Boots .....	48
Warnings .....	11-19	Rear Knuckle Grease Zerks .....	48
<b>Division II — Operation/ Maintenance</b>		Battery .....	49
Specifications .....	20	Spark Plug(s).....	52
Vehicle Operation .....	21-26	CVT Air Inlet .....	52
General Information .....	27-40	Primary Air Filter/Safety Filter/Clean-out Valve .....	53
Control Locations and Functions .....	27	Tires .....	55
Doors and Shoulder Bars.....	29	Wheels .....	55
Cargo Box Tie-Downs .....	29	Muffler/Spark Arrester .....	56
Tailgate Latches .....	30	Light Bulb Replacement .....	56
Cargo Box Latch Handles .....	30	Taillight/Brake Light Assembly .....	57
Behind-Seat Storage.....	30	Checking/Adjusting Headlight Aim .....	59
Power Steering (if equipped) .....	31	Fuses.....	60
LCD Information Gauge (Digital) .....	32	Electrical Output Terminals.....	60
Diagnostic Trouble Codes .....	34	Switched Accessory Power .....	60
Speed Limiter.....	35	Constant Accessory Power .....	60
Oil Level Stick .....	37	Storage Compartments/Tools.....	61
Load Capacity Ratings Chart .....	37	Seat Belts .....	61
Trailer and Towing .....	38	Doors.....	61
Transporting .....	38	Adjusting Doors.....	61
Gas — Oil — Lubricant .....	39	Occupant Shoulder Restraints .....	62
Engine Break-In .....	40	ROPS .....	62
Burnishing Brake Pads .....	40	<b>Preparation for Storage.....</b>	<b>63</b>
		<b>Preparation after Storage.....</b>	<b>63</b>
		<b>Warranty Procedure/Owner</b>	
		<b>Responsibility .....</b>	<b>64</b>
		<b>U.S. EPA Emission Control Statement/ Warranty Coverage (U.S. Only) .....</b>	<b>65</b>
		<b>California Emission Control Statement/ Warranty Coverage — OHRV (U.S. Only) .....</b>	<b>66</b>
		<b>Maintenance Record.....</b>	<b>67-68</b>
		<b>Change of Address, Ownership, or Warranty Transfer .....</b>	<b>69</b>
		<b>Identification Numbers Record .....</b>	<b>71</b>

# Division I — Safety

## This vehicle is not a toy and can be hazardous to operate.

- Always go slowly and be extra careful when operating on unfamiliar terrain. Always be alert to changing terrain conditions when operating this vehicle.
- Never operate on excessively rough, slippery, or loose terrain.
- Always follow proper procedures for turning as described in this manual. Practice turning at slow speeds before attempting to turn at faster speeds. Do not turn at excessive speed.
- Always have the vehicle checked by an authorized dealer if it has been involved in an accident.
- Never operate on hills too steep for your abilities. Practice on smaller hills before attempting larger hills.
- Always follow proper procedures for climbing hills as described in this manual. Check the terrain carefully before you start up any hill. Never climb hills with slippery or loose surfaces. Never depress the accelerator suddenly or make gear changes while moving. Never go over the top of any hill at high speed.
- Always follow proper procedures for going down hills and for braking on hills as described in this manual. Check the terrain carefully before you start down any hill. Never go down a hill at high speed. Avoid going down a hill at an angle which would cause the vehicle to lean sharply to one side. Go straight down the hill where possible.
- Always be careful when you decide to climb or descend a hill and never turn on a hill. Drive straight up or down inclines and not across them. If you must cross the side of a hill, drive slowly and stop or turn downhill if you feel the vehicle may tip over.
- Always use proper procedures if you stall or roll backward when climbing a hill. To avoid stalling, maintain a steady speed when climbing a hill. If you stall or roll backwards, follow the special procedure for braking described in this manual.
- Always check for obstacles before operating in a new area. Never attempt to operate over large obstacles, such as large rocks or fallen trees. Always follow proper procedures when operating over obstacles as described in this manual.
- Always be careful of skidding or sliding. On slippery surfaces, such as ice, go slowly and be very cautious in order to reduce the chance of skidding or sliding out of control.
- Never operate this vehicle in fast-flowing water or in water deeper than the floorboard. Remember that wet brakes may have reduced stopping capability. Test your brakes after leaving water. If necessary, apply them lightly several times to let friction dry out the pads.
- Always be sure there are no obstacles or people behind you when you operate in reverse. When it is safe to proceed in reverse, go slowly. Avoid turning at sharp angles in reverse.
- Always use the size and type tires specified in this manual. Always maintain proper tire pressure as described in this manual.
- Never improperly install or improperly use accessories on this vehicle.
- Never exceed the stated load capacity for this vehicle. Cargo should be properly distributed and securely attached. Reduce speed and follow instructions in this manual for carrying cargo or pulling a trailer and allow greater distance for braking.
- Operation of this vehicle is restricted to people 16 years of age and older who possess a valid driver's license. Passengers must be able to place both feet flat on the floor while keeping their back against the back of the seat and holding on to an available handhold.



**WARNING**

Indicates a hazardous situation which, if not avoided, could result in death or serious injury.

**3**

## Safety Alert

You should be aware that THIS VEHICLE IS NOT A TOY AND CAN BE HAZARDOUS TO OPERATE. This vehicle handles differently from other vehicles, including motorcycles and cars. A collision or rollover can occur quickly, even during what you think are routine maneuvers, such as turning, driving on hills, and going over obstacles, if you fail to take proper precautions.

### TO AVOID SERIOUS INJURY OR DEATH:

- \* Always read the Operator's Manual carefully and follow the operating procedures described. Pay special attention to the warnings contained in the manual and on all labels.
- \* Always wear the seat belt when operating or riding in this vehicle.
- \* Always follow these age recommendations:
  - Operation of this vehicle is restricted to people 16 years of age and older who possess a valid driver's license. Passengers must be able to place both feet flat on the floor while keeping their back against the back of the seat and holding on to the handhold.
- \* Never carry a passenger in the cargo box of this vehicle.
- \* Never operate this vehicle on a public road, even a dirt or gravel one, because you may not be able to avoid colliding with other vehicles.
- \* Always wear an approved helmet and protective gear.
- \* Never consume alcohol or drugs before or while operating this vehicle.
- \* Never operate this vehicle at excessive speeds. Go at a speed which is proper for the terrain, visibility conditions, and your experience.
- \* Never attempt to do wheelies, jumps, or other stunts.
- \* Always be careful when operating this vehicle, especially when approaching hills, turns, and obstacles and when operating on unfamiliar or rough terrain.
- \* Never operate this vehicle with the cargo box lifted or removed.
- \* Never operate this vehicle in fast-flowing water or in water deeper than the floorboard.
- \* Never operate this vehicle with the ROPS removed. The ROPS provides a structure helping to limit intrusions by branches or other objects and may reduce your risk of injury in accidents.
- \* Never put your hands or feet outside the vehicle for any reason while the vehicle is in motion. Do not hold onto the ROPS or hip restraint bar. If you think or feel the vehicle may tip, do not put your hands or feet outside the vehicle as they will not be able to prevent the vehicle from tipping. Any part of your body (arms, legs, or head) outside the vehicle can be crushed by passing objects, the vehicle, or ROPS.
- \* Always fasten occupant side restraints prior to moving the vehicle.



## Hangtags

This vehicle comes with hangtags containing important safety information. Anyone who operates the vehicle should read and understand this information before riding.

**THIS HANGTAG IS NOT TO  
BE REMOVED BEFORE SALE**

**This vehicle is  
equipped with a  
speed limitation  
device to limit  
the speed to**

**15 mph**

**if the driver's  
seatbelt is not  
fully engaged.**

2261-986



**WARNING**

Indicates a hazardous situation which, if not avoided, could result in death or serious injury.



## WARNING

Operating, servicing and maintaining a passenger vehicle or off-road vehicle can expose you to chemicals including engine exhaust, carbon monoxide, phthalates, and lead, which are known to the State of California to cause cancer and birth defects or other reproductive harm. To minimize exposure, avoid breathing exhaust, do not idle the engine except as necessary, service your vehicle in a well-ventilated area and wear gloves or wash your hands frequently when servicing your vehicle.

For more information, go to:

[www.P65Warnings.ca.gov/passenger-vehicle](http://www.P65Warnings.ca.gov/passenger-vehicle)

READ BOTH SIDES



## WARNING

### Electric-powered, Other Equipment

Operating, servicing and maintaining a passenger vehicle or off-road vehicle can expose you to chemicals including phthalates and lead which are known to the State of California to cause cancer and birth defects or other reproductive harm. To minimize exposure, wear gloves or wash your hands frequently when servicing your vehicle.

For more information, go to:

[www.P65Warnings.ca.gov/passenger-vehicle](http://www.P65Warnings.ca.gov/passenger-vehicle)

READ BOTH SIDES





# Important Safety Information

Anyone who operates the ROV should read and understand this information before operating this vehicle.

## **WARNING**

**IMPROPER USE OF OFF-HIGHWAY VEHICLES CAN CAUSE SEVERE INJURY OR DEATH.**

### **DRIVE RESPONSIBLY**

#### **AVOID LOSS OF CONTROL AND ROLLOVERS:**

- AVOID ABRUPT MANEUVERS, SIDEWAYS SLIDING, SKIDDING, OR FISHTAILING, AND NEVER DO DONUTS.
- SLOW DOWN BEFORE ENTERING A TURN.
- AVOID HARD ACCELERATION WHEN TURNING, EVEN FROM A STOP.
- PLAN FOR HILLS, ROUGH TERRAIN, RUTS, AND OTHER CHANGES IN TRACTION AND TERRAIN.
- AVOID PAVED SURFACES.
- AVOID SIDE HILLING. (RIDING ACROSS SLOPES)

## **WARNING**

**IMPROPER USE OF OFF-HIGHWAY VEHICLES CAN CAUSE SEVERE INJURY OR DEATH.**

### **ALWAYS:**

- FASTEN SEAT BELTS.
- WEAR AN APPROVED HELMET AND PROTECTIVE GEAR.
- MAKE SURE ALL SIDE RESTRAINTS ARE FULLY LATCHED.
- MAKE SURE OPERATORS ARE 16 OR OLDER WITH A VALID DRIVER'S LICENSE.



### **REQUIRE PROPER USE OF YOUR VEHICLE.**

DO YOUR PART TO PREVENT INJURIES:

#### **NEVER:**

- ALLOW CARELESS OR RECKLESS DRIVING.
- LET PEOPLE DRIVE OR RIDE AFTER USING ALCOHOL OR DRUGS.
- ALLOW OPERATION ON PUBLIC ROADWAYS. SUCH USE MAY BE HAZARDOUS AND A VIOLATION OF STATE OR LOCAL LAW. VEHICLE IS FOR OFF-HIGHWAY USE ONLY.
- EXCEED SEATING CAPACITY. MAKE SURE OCCUPANTS ONLY RIDE IN DESIGNATED SEATING POSITIONS, WITH ONE PERSON IN EACH SEATING POSITION.



EACH RIDER MUST BE ABLE TO SIT WITH BACK AGAINST SEAT, FEET FLAT ON FLOOR, AND HANDS ON STEERING WHEEL OR HANDHOLD(S). STAY COMPLETELY INSIDE VEHICLE.

### **BE SURE RIDERS PAY ATTENTION AND PLAN AHEAD.**

IF YOU THINK OR FEEL THE VEHICLE MAY TIP OR ROLL, REDUCE YOUR RISK TO INJURY:

- KEEP A FIRM GRIP ON THE STEERING WHEEL OR HANDHOLDS AND BRACE YOURSELF.
- DO NOT PUT ANY PART OF YOUR BODY OUTSIDE OF THE VEHICLE FOR ANY REASON.



**ROLLOVERS HAVE CAUSED SEVERE INJURIES AND DEATH. EVEN ON FLAT, OPEN AREAS.**

**AVOID STEEP HILLS AND NEVER CLIMB HILLS WITH SLIPPERY OR LOOSE SURFACES.**

**NEVER OPERATE AT SPEEDS TOO FAST FOR YOUR SKILLS OR THE CONDITIONS.**

**LOCATE AND READ OPERATORS MANUAL BEFORE USE. CONTACT MANUFACTURER FOR FREE REPLACEMENT. FOLLOW ALL INSTRUCTIONS AND WARNINGS.**

# Warning Labels

**▲ WARNING** (A)

IMPROPER USE OF OFF-HIGHWAY VEHICLES CAN CAUSE SEVERE INJURY OR DEATH. DRIVE RESPONSIBLY.

**AVOID LOSS OF CONTROL AND ROLLOVERS:**

- AVOID SHARP MANEUVERS, SIDEWAYS SLIDING, SHOCKING, OR FIGHTING AND NEVER DO DONUTS.
- SLOW DOWN BEFORE ENTERING A TURN.
- AVOID HARD ACCELERATION WHEN TURNING, EVEN FROM A STOP.
- PLAN FOR HILLS, SLOUGH TERRAIN, RUTS, AND OTHER CHANGES IN TRACTION AND TERRAIN.
- AVOID PAVED SURFACES.
- AVOID SIDE HILLING, RIDING ACROSS SLOPES.

**ROLLOVERS HAVE CAUSED SEVERE INJURIES AND DEATH, EVEN ON FLAT, OPEN AREAS.**

**AVOID:**

- AVOID STEEP HILLS.
- AVOID HILLS WITH SLIPPERY OR LOOSE SURFACES.
- DRIVE AT SPEEDS TOO FAST FOR YOUR SKILLS OR THE CONDITIONS.

**LOCATE AND READ OPERATOR MANUAL BEFORE USE. CONTACT MANUFACTURER FOR FREE REPLACEMENT. FOLLOW ALL INSTRUCTIONS AND WARNINGS.**

6411-021

SHEET  
P  
R  
N  
H  
L

**▲ WARNING** (B)

**TO AVOID SEVERE INJURY OR DEATH:**

**ALWAYS:**

- FASTEN SEAT BELTS.
- WEAR AN APPROVED HELMET AND PROTECTIVE GEAR.
- ENSURE ALL DOORS ARE FULLY LATCHED.
- MAKE SURE ALL OPERATORS ARE 16 OR OLDER WITH A VALID DRIVER'S LICENSE.
- MAKE SURE OCCUPANTS ONLY RIDE IN DESIGNATED SEATING POSITIONS WITH ONE PERSON IN EACH SEATING POSITION.

**NEVER:**

- ALLOW CARELESS OR RECKLESS DRIVING.
- LET PEOPLE DRIVE OR RIDE AFTER USING ALCOHOL OR DRUGS.
- ALLOW OPERATION ON PUBLIC ROADWAYS, SUCH USE MAY BE HAZARDOUS AND A VIOLATION OF STATE OR LOCAL LAW. VEHICLE IS FOR OFF-HIGHWAY USE ONLY.

**ENSURE PROPER USE OF YOUR VEHICLE:**

- IF YOU THINK OR FEEL THE VEHICLE MAY TIP OR ROLL, REDUCE YOUR RISK TO INJURY. KEEP A FIRM GRIP ON THE STEERING WHEEL OR HANDHOLDS AND BRACE YOURSELF.
- DO NOT PUT ANY PART OF YOUR BODY OUTSIDE OF THE VEHICLE FOR ANY REASON.
- EACH RIDER MUST BE ABLE TO SIT WITH BACK AGAINST SEAT, FEET FLAT ON FLOOR, AND HANDS ON STEERING WHEEL OR HANDHOLDS. STAY COMPLETELY INSIDE THE VEHICLE.

**DRIVER UNDER 16**

6411-035

**▲ WARNING** (C)

**NEVER HOLD ON TO THIS BAR.**

**HANDS AND ARMS COULD BE SERIOUSLY INJURED IN AN ACCIDENT.**

6411-495

**▲ WARNING** (D)

Vehicle rollover could cause **SERIOUS INJURY** or **DEATH**.

You must keep all parts of your body inside the vehicle.

**DO NOT** remove this ROPS.

This ROPS meets the performance requirements of ISO 3471, 29 CFR 1928.53, SAE J2258 SECTION 7.3.5-OPS

6411-019

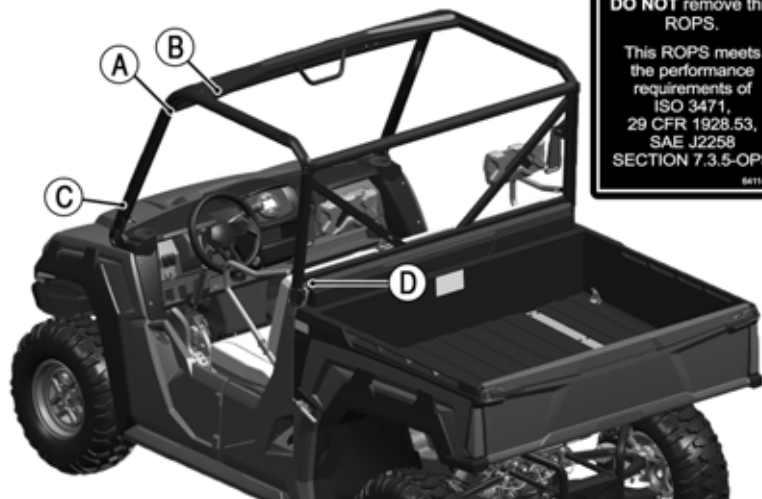

# Warning Labels

(A)

**⚠ WARNING**

**TO AVOID SEVERE INJURY OR DEATH:**

ALWAYS:

- KEEP WEIGHT IN THE CARGO BOX CENTERED, LOW AND FORWARD. TOP-HEAVY LOADS INCREASE THE RISK OF OVERTURN.
- BE SURE CARGO IS SECURED. A LOOSE LOAD COULD SHIFT AND CHANGE HANDLING UNEXPECTEDLY.
- REDUCE SPEED AND ALLOW MORE ROOM TO STOP WHEN LOADED OR TOWING.

NEVER:

- EXCEED THE VEHICLE LOAD CAPACITY INCLUDING WEIGHT OF OPERATOR, PASSENGER, CARGO, ACCESSORIES, AND TRAILER TONGUE. MAXIMUM LOAD IN CARGO BED: 1000 LBS (453 KG) (CALIFORNIA: 600 LBS (272 KG))
- CARRY PASSENGERS IN CARGO BED.
- TOW OR PULL PASSENGERS.

**⚠ WARNING**

IMPROPER TIRE PRESSURE OR OVERLOADING CAN CAUSE LOSS OF CONTROL. LOSS OF CONTROL CAN RESULT IN SEVERE INJURY OR DEATH.

COLD TIRE PRESSURE:	COLD TIRE PRESSURE WITH CARGO:
FRONT: 12 PSI (83 kPa)	FRONT: 12 PSI (83 kPa)
REAR: 14 PSI (97 kPa)	REAR: 16 PSI (110 kPa)

CARGO ≥ 500 LBS LIMITED TO 20 MPH

VEHICLE LOAD CAPACITY: 1500 LBS (680 KG)

7411-419



(B)

**⚠ WARNING**

Do not run engine without this shield in place or with drive belt removed.  
Do not attempt any adjustment with engine running.

9011-428

(C)

**⚠ WARNING**



- Keep hands, body and other persons away from closing cargo box.
- Do not operate the vehicle with cargo box up.

6411-496

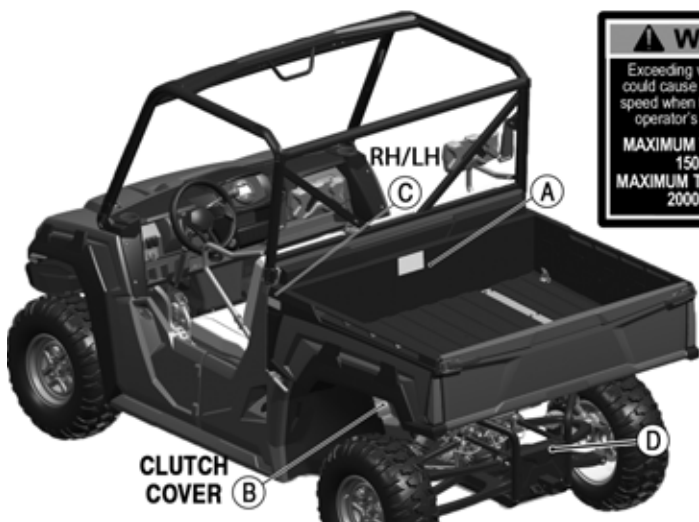

(D)

**⚠ WARNING**

Exceeding vehicle's towing limit could cause an accident. Reduce speed when towing a trailer. Read operator's manual for details.

**MAXIMUM TONGUE WEIGHT:**  
150 lbs (68 kg)

**MAXIMUM TOWING CAPACITY:**  
2000 lbs (907 kg)

6411-384



**WARNING**

Indicates a hazardous situation which, if not avoided, could result in death or serious injury.

# Location of Parts and Controls



MOD026B1



MODC049G



MOD027B1



MOD030B



MOD031B

1. Brake Fluid Reservoir
2. Gas Cap
3. Operator Side Cargo Box Tilt Lever
4. Operator Seat Belt
5. Operator Shoulder Restraint
6. Tilt Steering Wheel Lever
7. Headlight Switch
8. 2WD/4WD/Rear Axle Drive Select Switches
9. Ignition/Start Switch
10. DC Power Outlets
11. Storage
12. LCD Information Gauge
13. Shift Lever
14. Passenger Seat Belt
15. Passenger Side Cargo Box Tilt Lever
16. Engine Air Filter
17. Battery
18. Passenger Handhold
19. Passenger Shoulder Restraint
20. Tailgate Latch
21. Hitch
22. Hood Release Latch
23. Power Distribution Module (PDM)
24. Tow Hooks
25. Winch Fairlead Mount (if equipped)
26. Coolant Reservoir
27. Brake Pedal
28. Accelerator Pedal
29. Operator Door Release Latch
30. Passenger Door Release Latch
31. Winch Switch (if equipped)



# Warnings

## **WARNING**

### **POTENTIAL HAZARD**

Operating this vehicle without proper instruction.

### **WHAT CAN HAPPEN**

The risk of an accident is greatly increased if the operator does not know how to operate this vehicle properly in different situations and on different types of terrain.

### **HOW TO AVOID THE HAZARD**

All operators of this vehicle must read and understand this Operator's Manual and all warning and instruction labels prior to operating this vehicle.

## **WARNING**

### **POTENTIAL HAZARD**

Allowing anyone under age 16 to operate this vehicle.

### **WHAT CAN HAPPEN**

Use of this vehicle by children can lead to serious injury or death of the child. Children under the age of 16 may not have the skills, abilities, or judgment needed to operate this vehicle safely and may be involved in a serious accident.

### **HOW TO AVOID THE HAZARD**

Only people 16 years of age or older with a valid driver's license should operate this vehicle.

## **WARNING**

### **POTENTIAL HAZARD**

Operating or riding in the vehicle without wearing a properly secured seat belt.

### **WHAT CAN HAPPEN**

Serious injury or death. Occupants can strike objects in the passenger compartment, fall out of the vehicle during maneuvers, or be crushed or otherwise injured in the event of an accident.

### **HOW TO AVOID THE HAZARD**

ALWAYS WEAR YOUR SEAT BELT and require others to wear their seat belts. See the Operation/Maintenance section of this manual for more information on using your seat belt and both operator and passenger(s) wearing an approved helmet.

## **WARNING**

### **POTENTIAL HAZARD**

Operating this vehicle on public streets, roads, or highways.

### **WHAT CAN HAPPEN**

You can collide with another vehicle.

### **HOW TO AVOID THE HAZARD**

Never operate this vehicle on any public street, road, or highway. In many states it is illegal to operate a vehicle of this type on public streets, roads, or highways. Always check state and local laws and regulations.

## **WARNING**

Indicates a hazardous situation which, if not avoided, could result in death or serious injury. **11**

**⚠ WARNING**

**POTENTIAL HAZARD**

Operating or riding in this vehicle without wearing an approved helmet, and protective gear.

**WHAT CAN HAPPEN**

Operating or riding without an approved helmet increases your chances of a serious head injury or death in the event of an accident.

Operating or riding without eye protection can result in an accident and increases your chances of a serious injury in the event of an accident.

Operating or riding without protective clothing increases your chances of serious injury in the event of an accident.

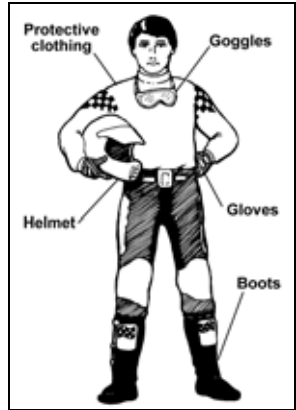

**HOW TO AVOID THE HAZARD**

Always wear an approved helmet that fits properly.

You should also wear:

- Eye protection (goggles or face shield)
- Gloves
- Boots
- Long-sleeved shirt or jacket
- Long pants

**⚠ WARNING**

**POTENTIAL HAZARD**

Operating this vehicle after or while consuming alcohol or drugs.

**WHAT CAN HAPPEN**

Could seriously affect your judgment.  
Could cause you to react more slowly.  
Could affect your balance and perception.  
Could result in an accident.

**HOW TO AVOID THE HAZARD**

Never consume alcohol or drugs before or while driving this vehicle.

**⚠ WARNING**

**POTENTIAL HAZARD**

Allowing passengers to ride in the cargo box.

**WHAT CAN HAPPEN**

Serious injury or death. This vehicle is not designed to carry passengers in the cargo box. Passengers in the cargo box can be thrown around or from the vehicle during operation or in an accident.

**HOW TO AVOID THE HAZARD**

Do not permit passengers to ride in the cargo box. Do not install any seating in the cargo box.

 **WARNING**

**POTENTIAL HAZARD**

Operating or riding in the vehicle without occupant side restraints properly secured.

**WHAT CAN HAPPEN**

Serious injury or death. Occupants or their body parts can strike objects outside the vehicle, be crushed by the vehicle, or fall out of the vehicle during maneuvers or in the event of an accident.

**HOW TO AVOID THE HAZARD**

Do not remove the occupant side restraints. Make sure both operator and passenger occupant side restraints are secure before operating or riding in the vehicle. Stay seated with your seat belt and helmet on and keep your body completely inside the vehicle during operation. See the Operation/Maintenance section of this manual for more information.

 **WARNING**

**POTENTIAL HAZARD**

Failing to keep all parts of your body inside the passenger compartment during operation.

**WHAT CAN HAPPEN**

Serious injury or death. Body parts could strike objects outside of vehicle or be crushed in the event of a rollover or accident.

**HOW TO AVOID THE HAZARD**

Do not place your head, arms, hands, legs, or feet outside of the passenger compartment during operation. Stay seated with your seat belt and helmet on and occupant side restraints properly secured. Keep your feet and legs inboard of the foot restraints at all times. Do not attempt to stop movement or tipping of the vehicle with your hands or feet. If you feel the vehicle tipping, brace your feet flat on the floor, keep hands firmly gripping the steering wheel (and handhold for outboard passenger), and keep all body parts inside the passenger compartment.

 **WARNING**

**POTENTIAL HAZARD**

Operating this vehicle at excessive speeds.

**WHAT CAN HAPPEN**

Increases your chances of losing control of the vehicle, which can result in an accident.

**HOW TO AVOID THE HAZARD**

Always ride at a speed that is proper for the terrain, visibility, load, and operating conditions.

 **WARNING**

**POTENTIAL HAZARD**

Attempting abrupt maneuvers, sideways sliding, skidding, fishtailing, or donuts.

**WHAT CAN HAPPEN**

Increases the chance of an accident including a rollover.

**HOW TO AVOID THE HAZARD**

Never attempt abrupt maneuvers, sideways sliding, skidding, fishtailing, or donuts. Don't try to show off.

 **WARNING**

**POTENTIAL HAZARD**

Failure to inspect this vehicle before operating.

Failure to properly maintain this vehicle.

**WHAT CAN HAPPEN**

Increases the possibility of an accident or equipment damage.

**HOW TO AVOID THE HAZARD**

Always inspect this vehicle each time you use it to make sure it is in safe operating condition.

Always follow the inspection and maintenance procedures and schedules described in this Operator's Manual.

 **WARNING**

**POTENTIAL HAZARD**

Failure to use extra care when operating this vehicle on unfamiliar terrain.

**WHAT CAN HAPPEN**

You can come upon hidden rocks, bumps, or holes without enough time to react.

Could result in the vehicle overturning or going out of control.

**HOW TO AVOID THE HAZARD**

Go slowly and be extra careful when operating on unfamiliar terrain.

Always be alert to changing terrain conditions when operating this vehicle.

 **WARNING**

**POTENTIAL HAZARD**

Failure to use extra care when operating on rough, slippery, or loose terrain.

**WHAT CAN HAPPEN**

Could cause loss of traction or control, which could result in an accident including a rollover.

**HOW TO AVOID THE HAZARD**

Do not operate on rough, slippery, or loose terrain until you have learned and practiced the skills necessary to control this vehicle on such terrain.

Always be especially cautious on these kinds of terrain.



**⚠ WARNING**

**POTENTIAL HAZARD**

Failing to use care in turns; turning too sharply or aggressively.

**WHAT CAN HAPPEN**

The vehicle could go out of control causing a collision, tip over, or rollover.

**HOW TO AVOID THE HAZARD**

Always follow proper procedures for turning as described in this Operator's Manual. Practice turning at slow speeds before attempting to turn at faster speeds. Do not turn at excessive speed or too sharply for the conditions and for your experience level. See the Operation/Maintenance section of this manual for more information on turning on flat ground, hills, sand, ice, mud, or water.

**⚠ WARNING**

**POTENTIAL HAZARD**

Operating on steep hills.

**WHAT CAN HAPPEN**

This vehicle can overturn more easily on steep hills than on level surfaces or small hills.

**HOW TO AVOID THE HAZARD**

Never operate the vehicle on hills too steep for the vehicle or for your abilities. Practice on smaller hills before attempting larger hills.

**⚠ WARNING**

**POTENTIAL HAZARD**

Operating with the ROPS removed.

**WHAT CAN HAPPEN**

Could lead to serious injury or death.

**HOW TO AVOID THE HAZARD**

Never operate this vehicle with the ROPS removed.



**⚠ WARNING**

**POTENTIAL HAZARD**

Going down a hill improperly.

**WHAT CAN HAPPEN**

Could cause loss of control or cause the vehicle to overturn.

**HOW TO AVOID THE HAZARD**

Always follow proper procedures for going down hills as described in this Operator's Manual.

Always check the terrain carefully before you start down any hill.

Never go down a hill at high speed.

Avoid going down a hill at an angle that would cause the vehicle to lean sharply to one side. Go straight down the hill where possible.

**⚠ WARNING**

Indicates a hazardous situation which, if not avoided, could result in death or serious injury. **15**

 **WARNING**

**POTENTIAL HAZARD**

Climbing hills improperly.

**WHAT CAN HAPPEN**

Could cause loss of control or cause the vehicle to overturn.

**HOW TO AVOID THE HAZARD**

Always follow proper procedures for climbing hills as described in this Operator's Manual.

Always check the terrain carefully before you start up any hill.

Never climb hills with slippery or loose surfaces.

Never open the throttle suddenly or make sudden gear changes. The vehicle could flip over backwards.

Never go over the top of any hill at high speed. An obstacle, a sharp drop, or another vehicle or person could be on the other side of the hill.

 **WARNING**

**POTENTIAL HAZARD**

Crossing hills or turning on hills.

**WHAT CAN HAPPEN**

Could cause loss of control or cause the vehicle to overturn.

**HOW TO AVOID THE HAZARD**

Avoid crossing the side of a hill or turning on a hill whenever possible. Never attempt to turn the vehicle around on any hill. If you must cross the side of a hill, drive slowly and stop or turn downhill if you feel the vehicle may tip.

 **WARNING**

**POTENTIAL HAZARD**

Stalling, rolling backwards, or improperly dismounting while climbing a hill.

**WHAT CAN HAPPEN**

Could result in the vehicle overturning.

**HOW TO AVOID THE HAZARD**

Use proper gear and maintain steady speed when climbing a hill.

If you lose all forward speed:

Apply the brakes. Place the transmission in park after you are stopped.

If you begin rolling backward:

Gradually apply the brakes while rolling backward.

When fully stopped, place the transmission in park.

 **WARNING**

**POTENTIAL HAZARD**

Improperly operating over obstacles.

**WHAT CAN HAPPEN**

Could cause loss of control or a collision. Could cause the vehicle to overturn.

**HOW TO AVOID THE HAZARD**

Before operating in a new area, check for obstacles.

Never attempt to ride over large obstacles, such as large rocks or fallen trees.

When you go over obstacles, always follow proper procedures as described in this Operator's Manual.

 **WARNING**

**POTENTIAL HAZARD**

Improperly operating in reverse.

**WHAT CAN HAPPEN**

You could hit an obstacle or person behind you, resulting in serious injury or death.

**HOW TO AVOID THE HAZARD**

Before you engage reverse gear, make sure there are no obstacles or people behind you. When it is safe to proceed, go slowly.

 **WARNING**

**POTENTIAL HAZARD**

Skidding or sliding.

**WHAT CAN HAPPEN**

You could lose control of the vehicle.

You could also regain traction unexpectedly, which may cause the vehicle to overturn.

**HOW TO AVOID THE HAZARD**

Learn to safely control skidding or sliding by practicing at slow speeds and on level, smooth terrain.

On extremely slippery surfaces, such as ice, go slowly and be very cautious in order to reduce the chance of skidding or sliding out of control.

 **WARNING**

**POTENTIAL HAZARD**

Overloading the vehicle or carrying or towing improperly.

**WHAT CAN HAPPEN**

Could cause changes in handling, which could lead to an accident.

**HOW TO AVOID THE HAZARD**

Never exceed the stated load capacity for this vehicle.

Cargo should be properly distributed and securely attached.

Reduce speed when carrying cargo or pulling a trailer. Allow greater distance for braking.

Always follow the instructions in this Operator's Manual for carrying cargo or pulling a trailer.

 **WARNING**

**POTENTIAL HAZARD**

Operating this vehicle through deep or fast-flowing water.

**WHAT CAN HAPPEN**

Tires may float, causing loss of traction and loss of control, which could lead to an accident.

**HOW TO AVOID THE HAZARD**

Never operate this vehicle in fast-flowing water or in water deeper than the floorboard. Remember that wet brakes may have reduced stopping capability.

Test the brakes after leaving water. If necessary, apply them several times to dry out the pads.

 **WARNING**

**POTENTIAL HAZARD**

Operating the vehicle with improper tires or with improper or uneven tire pressure.

**WHAT CAN HAPPEN**

Use of improper tires on the vehicle, or operating the vehicle with improper or uneven tire pressure, could cause loss of control increasing your risk of accident.

**HOW TO AVOID THE HAZARD**

Always use the size and type tires specified in this Operator's Manual for this vehicle. Always maintain proper tire pressure as described in this Operator's Manual.

 **WARNING**

**POTENTIAL HAZARD**

Operating this vehicle with improper modifications.

**WHAT CAN HAPPEN**

Improper installation of accessories or modification of the vehicle may cause changes in handling which could lead to an accident.

**HOW TO AVOID THE HAZARD**

Never modify this vehicle through improper installation or improper use of accessories. All parts and accessories added to this vehicle should be genuine TRACKER OFF ROAD components designed for use on this vehicle and should be installed and used according to instructions. If you have questions, consult an authorized TRACKER OFF ROAD dealer.

 **WARNING**

**POTENTIAL HAZARD**

Failing to avoid pinch-points when lowering the cargo box.

**WHAT CAN HAPPEN**

Fingers, hands, or arms could be seriously injured when lowering the cargo box.

**HOW TO AVOID THE HAZARD**

Always be aware of and avoid lowering cargo box until everyone is clear of pinch-points.



 **WARNING**

**POTENTIAL HAZARD**

Operating through or over thick or sharp brush, timber, debris, or rocks.

**WHAT CAN HAPPEN**

Serious injury or death. Brush, branches, debris, and rocks can enter or penetrate the passenger compartment and strike occupants. Running over sharp branches, rocks, or other large objects can also cause loss of control.

**HOW TO AVOID THE HAZARD**

Be alert. Slow down. Wear all recommended protective gear specified in this Operator's Manual. Avoid operating through or over thick brush, timber, debris, or large rocks whenever possible. Watch for and avoid sharp branches, rocks, or other large objects that could impede or impact the vehicle or enter the passenger compartment.

 **WARNING**

**POTENTIAL HAZARD**

Securing a person improperly in the vehicle due to physical size.

**WHAT CAN HAPPEN**

Serious injury or death. Occupant could strike objects in the passenger compartment, fall out of the vehicle during maneuvers, or be ejected and crushed in the event of an accident.

**HOW TO AVOID THE HAZARD**

Always make sure a passenger can sit with both feet flat on the floor and their back against the seat while being able to reach any provided handholds.

 **WARNING**

**POTENTIAL HAZARD**

Operating this vehicle on paved surfaces.

**WHAT CAN HAPPEN**

The vehicle's tires are designed for off-road use only, not for use on pavement. Paved surfaces may seriously affect handling and control of the vehicle and may cause the vehicle to go out of control.

**HOW TO AVOID THE HAZARD**

Whenever possible, avoid operating the vehicle on any paved surfaces including sidewalks, driveways, parking lots, and streets. If operating on paved surfaces is unavoidable, travel slowly (less than 10 mph [16 km/h]) and avoid sudden turns and stops.

**California Proposition 65**

 **WARNING**

The Engine Exhaust from this product contains chemicals known to the State of California to cause cancer, birth defects or other reproductive harm.

 **WARNING**

Indicates a hazardous situation which, if not avoided, could result in death or serious injury. **19**

# Division II — Operation/Maintenance Specifications

<b>ENGINE</b>	
Type	Four-Cycle/Liquid-Cooled
Bore	72 mm (2.835 in)
Stroke	66.5 mm (2.618 in)
Displacement	812 cc (49.55 cu in)
Spark Plug	F6RTC (p/n 3040-031)
Spark Plug Gap	1.0 mm (± 0.1 mm)
Target Idle RPM	950 ± 25
Max RPM	6300
<b>CHASSIS</b>	
Length (Overall)	320.04 cm (126 in) (800SX) 324.62 cm (127.8 in) (800SX LE)
Height (Overall)	187.96 cm (74 in)
Width (Overall)	160.02 cm (63 in)
Suspension Travel (Front/Rear)	25.4 cm (10 in) / 24.1 cm (9.5 in)
Tire Size (Front/Rear) (800SX)	26H x 9W R14 / 26H x 11W R14
Tire Size (Front/Rear) (800SX LE)	26H x 9W R14 / 26H x 11W R14
Tire Size (Front/Rear) (800SX LE)	27H x 9W R14 / 27H x 11W R14
Front Tire Inflation Pressure	(No Cargo) 12 psi (82.7 kPa) (w/Cargo) 12 psi (82.7 kPa)
Rear Tire Inflation Pressure	(No Cargo) 14 psi (96.5 kPa) (w/Cargo) 16 psi (110.3 kPa)
<b>MISCELLANEOUS</b>	
Dry Weight (Approx.)	724.4 kg (1597 lb) (800SX) 778.9 kg (1717 lb) (800SX LE)
Curb Weight	759.8 kg (1675 lb) (800SX) 814.2 kg (1795 lb) (800SX LE)
ROPS Tested Curb Weight	1587.6 kg (3500 lb)
Gas Tank Capacity	37.85 L (10 U.S. gal)
Coolant Capacity	5.67 L (6 U.S. qt)
Differential Capacity	198 mL (6.7 fl oz)
Transaxle Capacity	1.21 L (41.0 fl oz)
Engine Oil Capacity (Approx.)	2.37 L (2.5 U.S. qt)
Gas (Recommended)	Regular unleaded 87 octane (R+M)/2, ethanol content not to exceed 10%
Engine Oil (Recommended)	0W-40 (Synthetic)
Front Differential Lubricant	SAE-Approved 80W-90 Hypoid
Transaxle Lubricant	Transaxle Fluid with EP
Taillight/Brake Light	12.8 V — 27 W / 14 V — 8W
Headlight	12 V — 60 W/55 W
Starting System	Electric
Brake Type	Four-Wheel Hydraulic Disc Brake

Specifications subject to change without notice.

# Vehicle Operation

<b>Pre-Start/Pre-Operation Checklist</b>	
<b>Item</b>	<b>Remarks</b>
Brake System	Pedal firm — near top of travel. Fluid at proper level. Check for fluid leaks.
Controls	Steering free — no binding — no excessive free-play. Shift lever in park. Accelerator free — no binding — returns to idle position.
Fluids	Coolant level at halfway mark on bottle when cold. Check oil level. Gas tank full of recommended gasoline. Differential/rear drive at proper level. Check for fluid leaks.
Suspension	Ball joints/tie rod ends free — secure. Shocks not leaking — mountings secure. Shock spring preload equal on left and right. Components free of all debris.
Lights/Switches	Check light bar, light bar w/high beam, and light bar w/low beam — light switch to OFF. Check taillight/brake light — light switch to OFF. Check drive select switch — set to 2WD.
Air Filter	Clean-out valve clear of all debris. Ducting secure — no holes or tears.
Tires/Wheels	Properly inflated — tread adequate. Check tires for cuts or tears. Wheels secure to hubs — hubs secure to axles. Check wheels for cracked or bent rims.
Seat Belts/Restraints	Check condition — proper operation — proper adjustment.
Nuts/Bolts/Fasteners	Check for loose nuts and bolts — tighten as necessary. Check fasteners — latches — ROPS. Secure hood, cargo box and seats.

# Vehicle Operation

## Starting the Engine

Always start with the vehicle on a flat, level surface. Carbon monoxide poisoning can kill you, so keep the vehicle outside while it's running. Follow these steps to start it up:

1. Step into the vehicle and sit down; then fasten the operator seat belt and the passenger seat belts (if applicable) and secure your approved helmet or hard hat (if applicable) and require your passenger(s) to do the same (if applicable). Check that the occupant side restraints are secured in place.

### WARNING

**Falling from a moving vehicle could result in serious injury or death. Always fasten your seat belt securely and ensure the passenger seat belt is properly and securely fastened prior to operating or riding in this vehicle.**

2. Place the transmission in park; then depress the brake pedal.
3. Turn the ignition key clockwise to the START position; then when the engine starts, release to the RUN position. Do not increase engine RPM above idle.
4. Let the engine warm up to normal operating temperature.

### CAUTION

**Do not run the starter motor for more than 15 seconds per starting attempt. The starter motor may overheat causing severe starter motor damage. Allow 60 seconds between starting attempts to allow the starter motor to cool.**

## Shifting Transaxle

■ **NOTE:** When shifting, the operator is selecting a drive range in the transaxle and not in the Continuously Variable Transmission (CVT). The CVT is fully automatic and shifts as a function of engine RPM and vehicle loading.

### CAUTION

**Always come to a complete stop and allow the engine to return to idle before attempting to shift from one range to the other or into reverse. Always shift on level ground.**



MOD057A

1. To select reverse gear from park, move the shift lever downward one position until the letter "R" is displayed on the LCD information gauge.
2. To select neutral from reverse, move the shift lever downward one position until the letter "N" is displayed on the LCD information gauge.
3. To select high range from neutral, move the shift lever downward one position until the letter "H" is displayed on the LCD information gauge.
4. To select low range from high range, move the shift lever downward one position until the letter "L" is displayed on the LCD information gauge.



■ **NOTE:** The high range is for normal driving with light loads. The low range is for carrying heavy loads or trailer towing. Compared to HIGH range, the LOW range position provides slower speed and greater torque to the wheels.

### CAUTION

Always shift into low range when operating on wet or uneven terrain, when towing or pushing heavy loads, and when using a plow. Failure to follow this caution may result in premature V-belt failure or in damage to related drive system components.

5. To select park, move the shift lever completely up until the letter "P" is displayed on the LCD information gauge.

### CAUTION

Never increase engine speed above idle RPM when in park or belt damage will occur.

## Driving the Vehicle

Once the engine is at normal operating temperature, the vehicle is ready to be driven.

1. With the engine idling, press the foot brake pedal to apply the brake; then select the appropriate operating range and/or direction with the shift lever.
2. Release the foot brake pedal and press the accelerator to slowly add power to start moving.
3. To slow down or stop, release the accelerator and press the foot brake pedal as necessary to slow or stop the vehicle.

## Braking/Stopping

Always allow plenty of room and time to stop smoothly. Sometimes quick stops are inevitable, so always be prepared. Whether you're stopping slowly or stopping quickly, do this:

1. Release the accelerator; then press the foot brake pedal to apply the brake.

2. If the wheels lock, release them for a second; then apply them again. On surfaces such as ice, mud, or loose gravel, pump the brake pedal rapidly.
3. Never "ride" the brake. Even maintaining minimal pressure on the brake pedal will cause the brake pads to drag on the disc and may overheat the brake fluid.

### ⚠ WARNING

Excessive repetitive use of the hydraulic brake for high speed stops will cause overheating of the brake fluid and premature brake pad wear which will result in an unexpected loss of brakes.

### ⚠ WARNING

Use only manufacturer-approved brake fluid. Never substitute or mix different types or grades of brake fluid. Brake loss can result. Check brake fluid level and pad wear before each use. Brake loss can result in serious injury or death.

## Parking

Parking involves following the previous rules for braking; then:

1. After the vehicle stops, shift into park.
2. Turn off the ignition.

### ⚠ WARNING

Parking on any incline can allow the vehicle to move causing injury or damage.

### CAUTION

Parking on any incline puts excess loads on shifting mechanisms and can cause hard shifting and/or stress on parts.

If parking on a hill or any incline is the only alternative, use caution and follow these procedures after the vehicle stops:

1. Press and hold the brake pedal.
2. Shift into park.
3. Turn off the ignition.

- Slowly release brake pedal and verify vehicle is in park before getting out.



MOD026P

- Block rear wheels on the downhill side.

## Basic Turns

Steering effort is at its lowest in two-wheel drive (2WD). Greater effort is needed when in four-wheel drive (4WD). The greatest effort is needed when in four-wheel drive and the rear differential is locked.

Slow down before entering a turn. The basic turning technique is to drive at low speed and gradually adjust the amount of steering to suit the driving surface. Do not make sudden sharp turns on any surface. Refer to the sub-sections Driving Uphill, Driving Downhill, Crossing Obstacles, Driving in Reverse, Skidding or Sliding, Crossing Water, or Crossing Roads for more information.

If your vehicle ever skids sideways during a turn, steer in the direction of the skid. Also, avoid hard braking or accelerating until you have regained directional control.

### **WARNING**

Use care in turns — turning the steering wheel too far or too fast can result in loss of control or a rollover. Excessive speed, driving aggressively, or making abrupt maneuvers, even on flat, open areas, can cause loss of control, tipping, or rollover. Uneven terrain, rough terrain, soft surfaces, slippery surfaces, and paved surfaces can also cause a loss of control or rollover in a turn. On loose or soft surfaces, allow yourself more time and distance to turn and slow down.

## Driving Uphill

Always drive straight up the hill and always avoid hills that are very steep.

- Keep both hands on the wheel.
- Prior to starting the climb, shift into low range, select four-wheel drive for traction, and gradually press the accelerator; then maintain a constant speed.

### **WARNING**

Do not attempt to turn around on a hill.

### **WARNING**

Driving up hills improperly can cause loss of control of the vehicle resulting in serious injury or death. Use extreme care when driving in hilly terrain.

- If the vehicle stalls on a hill, press the foot brake pedal to apply the brake, shift into reverse, and slowly back down the hill. Do not attempt to turn around on a hill.

## Driving Downhill

Always drive straight down the hill and always avoid hills that are very steep.

- Keep both hands on the wheel.
- Prior to descending the hill, shift into low range and release the accelerator to allow maximum engine braking. Do not use four-wheel drive when descending a hill. Engine braking can cause the front wheels to slide reducing steering control.

■ **NOTE:** Use minimum braking (as necessary) to maintain a slow speed.

### **WARNING**

Do not attempt to turn around on a hill.

## **WARNING**

**Driving down hills improperly can cause loss of control of the vehicle resulting in serious injury or death. Never drive downhill at a high rate of speed. Use extreme care when driving in hilly terrain.**

### **Crossing Obstacles**

Crossing obstacles can be hazardous. There is always the possibility of the vehicle tipping. If you cannot go around an obstacle, follow these guidelines:

1. Stop the vehicle and place the transmission in park. Go out to inspect the obstacle thoroughly from both your approach side and the exit side. If you believe you can cross the obstacle safely, select four-wheel drive (4WD).

■ **NOTE: Selecting the LOCK position on the rear differential lock switch may be beneficial.**

2. Approach the obstacle as close as possible to 90° to minimize vehicle tipping.
3. Keep speed slow enough to maintain control but fast enough to maintain momentum.
4. Use only enough power to cross the obstacle but still give yourself plenty of time to react to changes in conditions. Crawl over the obstacle.

## **WARNING**

**Striking hidden obstacles can cause serious injury or death. Reduce speed and proceed with care in unfamiliar terrain.**

■ **NOTE: If there is any question about your ability to cross the obstacle safely, you should turn around if the ground is flat and you have room or back up until you find a less difficult path.**

### **Driving in Reverse**

When operating in reverse, avoid sharp turns and backing down a hill. When using reverse, follow these guidelines:

1. Back up slowly. It's hard to see behind you.

■ **NOTE: Avoid sudden braking while backing up.**

2. If possible, it is advisable to have someone "spotting" for you while backing up.
3. If you are unsure of what is behind the vehicle, place the transmission in park and get out and inspect the area behind.

■ **NOTE: This vehicle is equipped with a reverse limiter that is activated when the vehicle is in reverse and 2WD. The reverse limiter will limit the speed and RPM while driving in reverse. To override the reverse limiter, 4WD must be selected while in reverse.**

### **Skidding or Sliding**

If you lose control after hitting sand, ice, mud, or water, follow these guidelines:

1. Turn the steering wheel into the direction of the slide.
2. Keep your foot off the brake until you're out of the skid.
3. Stop and shift into four-wheel drive.

### **Crossing Water**

This vehicle can only operate in water up to its floorboard. Stay away from fast-moving rivers. This vehicle's tires can be buoyant. In deep water, the vehicle may lose traction due to floating.

1. Physically check the depth and current of the water, especially if you can't see the bottom. Also, check for boulders, logs, or any other hidden obstacles.
2. Keep speed slow while maintaining momentum.
3. Make sure you have a way out on the other side of the water.
4. Once you've cleared the water, briefly apply the brakes to make sure they work.

■ **NOTE:** Light pedal pressure or pumping the brakes for a short distance will aid in drying the brakes.

 **WARNING**

**Do not operate this vehicle on a frozen body of water unless you have first verified the ice is sufficiently thick to support the vehicle, cargo, and participants. The vehicle could break through the ice causing serious injury or death.**

### **Crossing Roads**

It may be necessary to cross a road or highway. If so, note the following guidelines:

1. Stop completely on the shoulder of the road.
2. Check both directions for traffic.
3. Crossing near a blind corner or intersection is dangerous; avoid it if at all possible.
4. Drive straight across to the opposite shoulder.
5. Take into account that this vehicle could stall while crossing; give yourself enough time to get off the road.
6. You have to assume that oncoming cars don't see you, and if they do, they won't be able to predict your actions.

7. It's illegal to cross public roads in some places. Know your local laws.

### **Shutting Down Properly**

This vehicle is equipped with an electronic cooling fan to aid in cooling the engine. The fan operates when coolant temperatures exceed predetermined thresholds and shuts off when coolant returns to normal temperature.

Do not shut vehicle off if the cooling fan is operating. When the fan stops, shut down vehicle.

■ **NOTE:** The vehicle should be allowed to idle until fan shuts off indicating the engine has returned to normal temperature.

**CAUTION**

**If coolant temperature continues to increase, the vehicle should be taken to an authorized dealer for inspection.**

### **Plan Ahead**

Always bring basic items to make your experience safe and enjoyable. Be prepared for whatever you may encounter.

- First-aid kit\*
- Food and water
- Tool kit\*
- Cell phone

\*Storage locations and potential storage locations are covered later on in this manual.

# General Information

■ **NOTE:** This vehicle is equipped with a speed limitation device to limit the speed to 15 mph (24 km/h) if the operator's seat belt is not fully engaged. The seat belt indicator light will remain illuminated until the operator's seat belt is fully engaged.

## Control Locations and Functions

### Ignition Switch Key

Two keys come with this vehicle. Keep the spare key in a safe place. An identifying number is stamped on each key. Use this number when ordering a replacement key.

### Ignition Switch

The ignition switch has three positions.

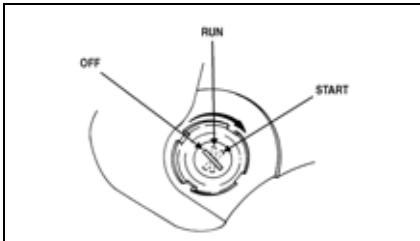

ATV-0056A

**OFF** position — All electrical circuits except the accessory are off. The engine will not start. The key can be removed in this position.

■ **NOTE:** The accessory plugs are powered by the battery at all times.

**RUN** position — The starter circuit is complete and the engine can run. The key cannot be removed in this position.

**START** position — The starter circuit is complete and the starter is engaged. When the key is released, the switch will return to the RUN position. The key cannot be removed in this position.

■ **NOTE:** This vehicle has safety interlock switches which prevent the starter motor from activating when the brake pedal is not depressed.

## Shift Lever

This vehicle has a Continuously Variable Transmission (CVT) which transfers power to the dual range transmission. High range, low range, neutral, reverse and park are selected by the operator with the shift lever.



MOD700

## Drive Select Switches



MOD184

The left-hand 2WD/4WD switch allows the operator to operate the vehicle in either two-wheel drive (rear wheels) or four-wheel drive (all wheels). The right-hand switch allows the operator to mechanically lock the rear axle to apply equal power to both rear wheels. Both switches can be used together to achieve 4WD rear axle lock.

For normal driving on flat, dry, and hard surfaces, two-wheel drive without rear axle lock should be sufficient.

■ **NOTE:** This vehicle is equipped with a reverse limiter that is activated when the vehicle is in reverse and 2WD. The reverse limiter will limit the speed and RPM while driving in reverse. To override the reverse limiter, 4WD must be selected while in reverse.

In situations when additional traction is necessary, rear axle lock or four-wheel drive would be the desired choice. Some situations may require four-wheel drive and rear axle lock.

## Drive Selection



MOD184

To select 2WD, depress the bottom of the 2WD/4WD switch. To select 4WD, move the switch to the opposite position. To engage the rear axle lock, push the top of the rear axle lock switch.

The indicator will change with each selection.

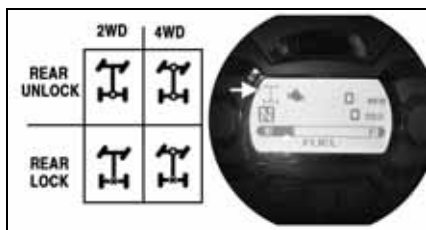

MOD339

■ **NOTE: Maneuverability and handling characteristics will differ with the rear axle lock engaged.**

## Foot Brake

The foot brake is the only service brake, and it should be applied whenever braking is needed.

Apply the brake by pressing the brake pedal down.

## Steering Wheel Tilt Latch

Pull on the lever located on the steering column and move the steering wheel to the desired position; then release the lever and make sure the steering wheel locks securely.



MOD183

## Headlight Switch

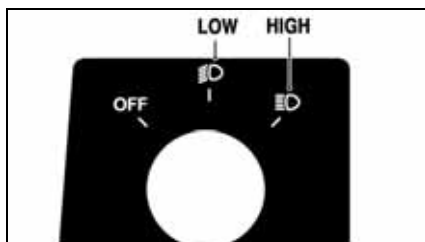

MODC036

With the ignition switch in the RUN position, use the headlight switch to select low beam or high beam. The taillights work in all positions except OFF. The brake lights work in all light positions.

## Accelerator Pedal

Press down on the pedal to increase engine RPM and vehicle speed; release the pedal to decrease engine RPM and vehicle speed.

■ **NOTE: This vehicle is equipped with an RPM limiter that retards the electronic throttle body, fuel injectors and ignition timing when maximum RPM is approached.**

## Operator Seat

1. The operator's seat is not removable without tools.
2. To lock the seat into position, slide the rear of the seat into the seat retainers and push down firmly on the front of seat. The seat must engage the retainers and lock into position.

### **WARNING**

**Make sure the seat is secure before driving the vehicle. Serious injury or death could result if the seat is not properly secured.**

## Passenger Seats

1. To remove a seat, lift up on the front of the seat; then raise the front of the seat and slide it out of its rear retainers.
2. To lock the seat into position, slide the rear of the seat into the seat retainers and push down firmly on the front of seat. The seat must engage the retainers and lock into position.

### **WARNING**

**Make sure the seats are secure before driving the vehicle. Serious injury or death could result if the seats are not properly secured.**

## Seat Belts

■ **NOTE:** This vehicle is equipped with a speed limitation device to limit the speed to 15 mph (24 km/h) if the operator's seat belt is not fully engaged. The seat belt indicator light will remain illuminated until the operator's seat belt is fully engaged.

This vehicle is equipped with seat belts for the operator and the passenger(s). To fasten and release the seat belt properly, use the following procedure:

1. Place the seat belt across your lap as low as possible without twisting the belt, making sure the shoulder strap is below the neck and across the chest.

### **WARNING**

**Only appropriate-sized passengers may ride in this vehicle. Passengers must be able to place both feet flat on the floor while keeping their back against the back of the seat and holding on to the handholds (outboard passenger only).**

2. Push the latch plate into the buckle slot until it "clicks" and latches securely. The belt will retract when the buckle is released.

### **WARNING**

**Falling outside a moving vehicle could result in serious injury or death. Always fasten your seat belt securely and ensure the passenger seat belt is properly and securely fastened prior to operating or riding in this vehicle.**

## Doors and Shoulder Bars

In addition to the seat belts, there are left- and right-side doors and shoulder bars to restrict arms or legs from extending outside the vehicle. The doors should always be secured when the vehicle is moving.

Never operate the vehicle with the doors or shoulder bars removed or not secured.

## Cargo Box Tie-Downs

The cargo box has numerous tie-down locations around the top perimeter and in each corner of the cargo box floor. Always secure cargo with tie-down straps to avoid shifting or damage to cargo.

Tie-down locations (1) should not be used as a sole tie-down location for heavy loads.

Use tie-down locations (2) as the main tie point to secure heavy loads and tie-down locations (1) as a secondary tie point.

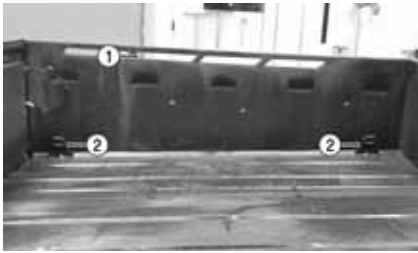

MOD118A

## CAUTION

When using ratchet-type straps, do not over tighten or damage to the cargo box could occur.

■ **NOTE:** Always refer to the Load Capacity Ratings chart in this manual when loading and hauling cargo.

## Tailgate Latches



MOD701A

1. To open the tailgate, pull the latch handles (1) (located on the end of the tailgate).
2. To close the tailgate, lift up and push forward firmly. Hook the latch bails (2) and push the handles forward over center.



MOD109A

## Cargo Box Latch Handles



MOD062A

1. To raise the cargo box, lift the handle upward; then raise the cargo box.
2. To lower the cargo box, push down firmly on the front of the box. The box will automatically lock into position.

## Behind-Seat Storage

A storage compartment is located behind the passenger seats. This storage location is not watertight.

A first-aid kit, fire extinguisher and vehicle recovery equipment can be stored in this location. Fire extinguishers should be secured and not allowed to roll around.

If emergency equipment is stored out of sight, be sure to clearly identify the locations of those items.



MOD122



To access behind-the-seat storage, turn the 1/4-turn fastener clockwise and tilt the seat backrest forward.



MOD121A

The storage compartment is designed to be a perfect fit for the passenger seat bottom(s).

1. Fold the passenger seat backrest(s) down and place the seat bottom(s) into the marked holding position(s) in the storage compartment.



MOD151A

## Power Steering (if equipped)

Certain vehicles were produced with an Electronic Power Steering (EPS) system to reduce steering effort and operator fatigue over a broad range of operating conditions.

The EPS system engages when the ignition switch is turned to the ON position and disengages after approximately five minutes (to conserve battery power) if the engine is not running.

This system is entirely maintenance-free: no adjustment or servicing is required. There are no fluids to check or change, and the EPS system is entirely self-contained and sealed to protect it from the elements.

The EPS system is battery system powered; therefore, the battery must be in good condition and fully charged. Power delivery and overload protection is provided by an EPS relay and 30-amp fuse located under the hood in the Power Distribution Module (PDM).

The system is self-monitored and will display a malfunction code on the LCD information gauge should an EPS system control circuit problem occur.

Code	Fault Description
C1351	Motor Position Index
C1352	Motor Position Plausibility
C1353	Motor Position Range
C1354	Internal Voltage Supply
C1355	Session Error
C1356	Torque Sensor Open Circuit
C1357	Torque Sensor Range
C1358	Torque Sensor Over Range
C1359	Torque Sensor Communication
C1360	Internal Processor Error
C1361	Temperature Sensor Circuit
C1362	Stuck at Bootloader
C1363	Calibration Values Not Programmed
C1364	Calibration Checksum
C1365	Application Checksum
C1366	Variant Coding Error
C1367	Vehicle Speed
C1368	ECM CAN Bus Error
C1369	Gauge CAN Bus Error
C1370	CAN Bus Error
C1371	Over Temp Condition
C1372	Battery Voltage Low
C1373	Battery Voltage High
C1374	Over Current Error
C1375	System Voltage High
C1376	Current Sensor Range

■ **NOTE:** The code reset procedure is to turn the key switch to the OFF position, then back to the ON position. If the code continues to be displayed, take your vehicle to an authorized dealer for EPS system servicing before resuming operation.

### CAUTION

Never operate this vehicle with an EPS code indicated on the LCD information gauge that cannot be turned off using the reset procedure. This indicates a malfunction in the EPS system control circuit and could result in a loss of power steering assist.

In the event of electrical power failure, the EPS system becomes disabled (similar to an automobile with the engine shut off). Steering effort increases but steering control can be maintained.

### LCD Information Gauge (Digital)

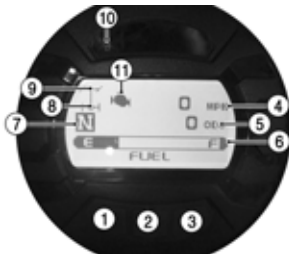

MOD338

- (1) Left Button — Shifts top display through speedometer, RPM, and clock.
- (2) Middle Button — Shifts middle display through speedometer, RPM, clock, odometer, trip 1, trip 2, and engine hours.
- (3) Right Button — Shifts bottom display through coolant temperature, battery voltage, and fuel level.

- (4) Speedometer/Tachometer/Clock Display — Indicates approximate vehicle speed in MPH or KM/H when speedometer function is selected, RPM when tachometer function is selected, or time when clock is selected. Press the Left Button to change which parameter is being displayed. With speedometer selected, press and hold the Left Button to shift between standard (mph/miles/Fahrenheit) and metric (km/h/kilometers/Celsius).

With the clock mode selected, press and hold the Left Button to start the process to set the clock. The option of selecting the 12-hour or 24-hour clock is available; press the Left Button to alternate between the two modes. Next, press the Middle Button to choose the hour and minutes. Press the Left or Right Button to set the hour; then press the Middle Button to choose the minutes. Press the Left or Right Button to set the minutes. When the proper time has been set, press the Middle Button to return to the main gauge display.

- (5) Engine Hour Meter/Odometer/Trip Meter/Speedometer/Tachometer/Clock Display — Displays engine hours, odometer, trip meter, speedometer, tachometer, or clock. Press the Middle Button to change which parameter is being displayed. The Engine Hour Meter and Odometer cannot be reset. To reset the trip meter, select the Trip Meter; then press and hold the Middle Button until the trip meter display reads 0.

■ **NOTE:** The engine hour meter will not activate until engine speed exceeds 500 RPM.

■ **NOTE:** An item can only be displayed in the middle position (5) if it is not already displayed in the top position (4). To set the clock when the clock is in the middle position, press and hold the Middle Button; then use the procedure found in 4.

- (6) Coolant Temperature/Battery Voltage/Fuel Level Display — Displays coolant temperature, battery voltage, and fuel quantity. Press the Right Button to change which parameter is being displayed. Press and hold the Right Button to see the actual values associated with the mode selected.
- (10) Seat Belt Reminder Indicator — Each time the ignition switch is turned ON, the indicator will illuminate on the speedometer until the operator's seat belt is secured to remind occupants to secure their seat belts.

### CAUTION

Continued operation with high engine temperature may result in engine damage or premature wear.

■ **NOTE:** High engine RPM, low vehicle speed, or heavy load can raise engine temperature. Decreasing engine RPM, reducing load, and selecting an appropriate transmission gear can lower the temperature.

■ **NOTE:** Debris in the engine compartment (or packed between the cooling fins of the radiator) can reduce cooling capacity. Using a garden hose, wash the radiator and the engine to remove any debris preventing air flow.

### CAUTION

The manufacturer does not recommend using a pressure washer to clean the radiator core. The pressure may bend or flatten the fins causing restricted air flow, and electrical components on the radiator could be damaged. Use only a garden hose with spray nozzle at normal tap pressure.

- (7) Gear Position Indicator — Indicates which gear is selected.
- (8) Rear Axle Lock Indicator — Displays an X between rear wheels when the axle lock has been engaged. Displays an O between rear wheels when the axle lock is disengaged.
- (9) Drive Select Indicator — Displays an O between the front wheels when the 4WD drive mode is selected by the drive select switch.

### ⚠ WARNING

The seat belt indicator and RPM limiter are a reminder and will turn off after the operator's seat belt is secured. It does not indicate that all seat belts are properly secured. It is the operator's responsibility to ensure all vehicle occupants are properly seated with seat belts secure and doors are properly latched. Serious injury or death could occur as a result of falling outside a moving vehicle.

- (11) Electronic Fuel Injection (EFI) Malfunction Indicator — A diagnostic trouble code (see list) and engine icon will be displayed on the LCD information gauge whenever an EFI error is detected. The code and engine icon will continue to be displayed on the LCD information gauge until the error is corrected.



MOD102A

■ **NOTE:** Take the vehicle to an authorized dealer to have the error corrected and the system error reset as soon as possible.

## Diagnostic Trouble Codes

Display	Fault Description	Display	Fault Description
C0063	Tilt Sensor Circuit High	P0267	Cylinder #3 Fuel Injector Circuit Low/SG
C0064	Tilt Sensor Circuit Low/SG/Open	P0268	Cylinder #3 Fuel Injector Circuit High
C1263	Backup/Reverse Circuit Open	P0325	Knock Sensor Range/Performance
C1264	Backup/Reverse Buzzer Circuit High	P0326	Knock Sensor Intermittent/Erratic
C1265	Backup/Reverse Circuit Low/SG	P0363	Misfire Detected — Fueling Disabled
P0030	Oxygen Heater Intermittent/Open	P0370	Loss of Crankshaft Position Sensor Synchronization/Gap Position
P0031	Oxygen Heater Low/SG	P0371	Crankshaft Position Sensor Additional Teeth Detected
P0032	Oxygen Heater High/SP	P0372	Crankshaft Position Sensor Missing Tooth
P0068	Throttle Position Sensor MAP Plausibility	P0373	Crankshaft Position Sensor Spike Detected
P0107	MAP Sensor Circuit Low/SG/Open	P0374	Crankshaft Position Sensor Signal Not Detected
P0108	MAP Sensor Circuit High/SP	P0444	EVAP System Purge Control Valve Circuit Open
P0112	Intake Air Temp Sensor Circuit Low/SG	P0458	EVAP System Purge Control Valve Circuit Low/SG
P0113	Intake Air Temp Sensor Circuit High/Open	P0459	EVAP System Purge Control Valve Circuit High/SP
P0114	Intake Air Temp Sensor Circuit Intermittent	P0480	Fan-Primary Relay Control Circuit Open
P0116	Engine Coolant Temp Sensor Circuit Range/Performance	P0481	Fan-Secondary Relay Control Circuit Open
P0117	Engine Coolant Temp Sensor Circuit Low/SG	P0500	Vehicle Speed-Sensor
P0118	Engine Coolant Temp Sensor Circuit High/Open/SP	P0503	Vehicle Speed Sensor Circuit Intermittent/Erratic/High
P0122	Throttle Position Sensor #1 Circuit Low/SG	P0504	Brake Switch Priority
P0123	Throttle Position Sensor #1 Circuit High/Open	P0562	System Voltage Low
P0130	Oxygen Sensor Intermittent/Open	P0563	System Voltage High
P0131	Oxygen Sensor Low/SG or Air-Leak	P0600	Serial Communication Link
P0132	Oxygen Sensor High/SP	P0606	Internal Monitoring Error
P0171	Oxygen Feedback Below Minimum Correction	P060C	Internal Monitoring 3 Error
P0172	Oxygen Feedback Exceeds Maximum Correction	P0615	Starter Relay Circuit
P0201	Cylinder #1 Fuel Injector Circuit Open	P0616	Starter Relay Circuit Low
P0202	Cylinder #2 Fuel Injector Circuit Open	P0617	Starter Relay Circuit High
P0203	Cylinder #3 Fuel Injector Circuit Open	P061A	Internal Monitoring of Torque Error
P0217	Engine Coolant Over Temperature Detected	P061F	Electronic Throttle Control Driver Temperature Warning
P0219	Engine Over-Speed Condition	P0627	Fuel Pump Control Circuit Open
P0222	Throttle Position Sensor #2 Circuit Low/SG/Open	P0628	Fuel Pump Control Circuit Low/SG
P0223	Throttle Position Sensor #2 Circuit High	P0629	Fuel Pump Control Circuit High/SP
P0261	Cylinder #1 Fuel Injector Circuit Low/SG	P0630	VIN Not Programmed or Incompatible
P0262	Cylinder #1 Fuel Injector Circuit High	P0641	Sensor Reference Voltage #1 Circuit Low/Open
P0264	Cylinder #2 Fuel Injector Circuit Low/SG	P0643	Sensor Reference Voltage #1 Circuit High
P0265	Cylinder #2 Fuel Injector Circuit High	P0651	Sensor Reference Voltage #2 Circuit Low/Open
		P0653	Sensor Reference Voltage #2 Circuit High

Display	Fault Description
P0685	EFI/Main Relay Circuit Open
P0686	EFI/Main Relay Circuit Low/SG
P0687	EFI/Main Relay Circuit High/SP
P0691	Fan-Primary Relay Control Circuit Low/SG
P0692	Fan-Primary Relay Control Circuit High/SP
P0693	Fan-Secondary Relay Control Circuit Low/SG
P0694	Fan-Secondary Relay Control Circuit High/SP
P1120	Throttle Position Sensor Lower Position
P1121	Throttle Position Sensor Lower Adaption
P1122	Throttle Position Sensor Lower Return
P1123	Throttle Position Sensor Adaption Condition
P1124	Throttle Position Sensor Limp Home Adaption
P1125	Throttle Position Sensor Upper Position
P1126	Throttle Position Sensor Upper Return
P2100	Throttle Actuator Control Motor Circuit Open
P2102	Throttle Actuator #1 Control Motor Circuit Low/SG
P2103	Throttle Actuator #1 Control Motor Circuit High/SP
P2106	Electronic Throttle Control Output Is Out Of Range
P2107	Electronic Throttle Control Driver Over-Temperature
P210C	Throttle Actuator #2 Control Motor Circuit Low/SG
P210D	Throttle Actuator #2 Control Motor Circuit High/SP
P2118	Throttle Actuator Control Motor Range Error
P2119	Throttle Control Actuator Control Performance Error
P2122	Pedal Position Sensor #1 Circuit Low/Open/SG
P2123	Pedal Position Sensor #1 Circuit High/SP
P2127	Pedal Position Sensor #2 Circuit Low/Open/SG
P2128	Pedal Position Sensor #2 Circuit High/SP
P2135	Throttle Position Sensor Plausibility Error
P2138	Pedal Position Sensor Plausibility Error

Display	Fault Description
P2299	Brake Pedal Position/Accelerator Pedal Position Incompatible
P2300	Ignition Coil #1 Primary Circuit Low/SG/Open
P2301	Ignition Coil #1 Primary Circuit High
P2303	Ignition Coil #2 Primary Circuit Low/Open
P2304	Ignition Coil #2 Primary Circuit High
P2306	Ignition Coil #3 Primary Circuit Low/Open
P2307	Ignition Coil #3 Primary Circuit High
P2610	ECU Warm Reset
U0100	Lost Communication with ECM
U0155	LCD Gauge to ECM CAN Communication Lost
FUEL OFF	Tilt Sensor Activation Code

## Speed Limiter

This vehicle is equipped with a speed limiter that can be changed through the LCD information gauge. To change or check the speed limiter, use the following procedure:

■ **NOTE:** The three buttons on the gauge are the left (A), middle (B), and right (C).



MOD258

1. Turn the ignition switch to the RUN position.
2. Hold the left and right buttons of the gauge simultaneously until DIAGNOSTIC MENU is displayed.
3. Scroll up by pressing the right button or down by pressing the left button until ADVANCED is displayed; then press the middle button to SELECT.



MOD255

4. Scroll up by pressing the right button or down by pressing the left button until VEH SPEED is displayed. This is the menu to set the speed limiter; press the middle button to SELECT.



MOD256

5. Scroll up by pressing the right button or down by pressing the left button until the desired speed limiter value is achieved; then press the middle button to SET. To password protect the limited speed, proceed to step 6. If password protection is not desired, exit this menu by scrolling up with the right button or down with the left button until EXIT is displayed; then press the middle button to SET.



MOD294

6. To password protect the limited speed, scroll up by pressing the right button or down by pressing the left button until ADV PASSWD is displayed; then press the middle button to SELECT.



MOD259

■ **NOTE:** When ADV PASSWD is enabled, entering a password to navigate into the ADVANCED menu is required. For this reason, it is recommended to write down the code and store in a safe place. If the code is forgotten, the vehicle must be taken to an authorized dealer to be reset.

7. Scroll up by pressing the right button or down by pressing the left button until ADV PASSWD ENABLE is displayed; then press the middle button to SET.



MOD260

8. Enter the desired code one digit at a time by pressing the right button or left button until the desired number is achieved and pressing the middle button to SET; then repeat until all four numbers are entered and set.
9. To exit this menu, scroll up by pressing the right button or down by pressing the left button until EXIT is displayed; then press the middle button to SELECT.

## Oil Level Stick

There is an oil level stick for checking the engine oil level. To check the oil level, use the following procedure:

■ **NOTE:** The vehicle should be on level ground when checking the engine oil level.

1. Lift the cargo box.
2. Remove the oil level stick and wipe it with a clean cloth.

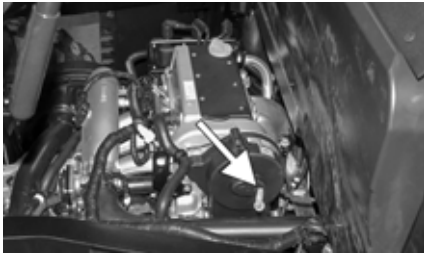

MOD021A

3. Install the oil level stick.

■ **NOTE:** The oil level stick should be fully seated for checking purposes.

4. Remove the oil level stick; the engine oil level should be within the operating range.

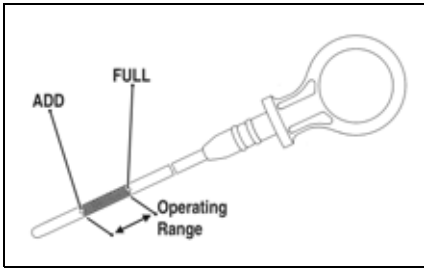

MOD-OIL-GA

**CAUTION**  
Do not overfill the engine with oil. Always make sure the oil level is within the operating range but not above the FULL mark.

5. To add oil, the cargo box must be tilted up. Remove the oil fill cap. After adding oil, install the oil fill cap and tighten securely.



MOD064

6. Check the oil level after additional oil is added to the engine and confirm the oil is within the operating range.

## Load Capacity Ratings Chart

This vehicle must always be loaded in accordance with the Load Capacity Ratings chart. Under no circumstances should the Vehicle Load Capacity (Payload) rating ever be exceeded.

**WARNING**  
Overloading this vehicle could result in loss of control resulting in serious injury or death.

Item	Specifications	
	(lb)	(kg)
Vehicle Load Capacity (Payload)	1500	680
Tongue Weight	150	68
Rear Tongue and Cargo Weight (max)	1000	453
Towing Capacity	2000	907

**Vehicle Load Capacity (Payload)** — Total weight of operator, passenger(s), trailer tongue weight, accessories, cargo, and storage compartments. **Any combination of these must not exceed 1500 lb (680 kg).**

**Tongue Weight** — Weight on trailer tongue.

**Accessory Weight** — Winch, gun scabbard brackets, snow plow, etc.

**Rear Tongue and Cargo Weight** — Total weight on trailer tongue and cargo box.

**Rear Tongue, Cargo, and Storage Compartments Weight** — Total weight on trailer tongue, cargo box, and storage compartments.

**Towing Capacity** — Total weight of trailer and all cargo in the trailer.

# Trailer and Towing



MOD001B

This vehicle is equipped with a rear frame-mounted receiver for a standard 5.1 cm (2 in) receiver hitch.

## **⚠ WARNING**

Make sure that the load in the trailer is properly secured and will not shift while moving. Also, do not overload the trailer.

When loading a trailer properly, two items are critical: Gross Trailer Weight (the weight of the trailer plus cargo) and Trailer Tongue Weight.

## **⚠ WARNING**

Never exceed any of the vehicle weight restrictions.

Trailer Tongue Weight is the downward force exerted on the hitch by the trailer coupler when the trailer is fully loaded and the coupler is at its normal towing height. Refer to the Load Capacity Ratings Chart for tongue weight information.

Always maintain a slow speed when trailering and towing and avoid sudden acceleration, quick maneuvers, and sudden stops. Braking distance will be affected when towing a trailer. When towing a trailer, always maintain slow speed and allow more stopping distance than when not towing a trailer.

## **⚠ WARNING**

Operating this vehicle without extra caution when towing a trailer will be hazardous. Trailer towing can affect the handling and braking of the vehicle. Tow only at low speeds and never exceed 10 mph (16 km/h). Avoid sudden acceleration and stopping of the vehicle. Do not make quick maneuvers. Avoid uneven surfaces and do not tow on hills.

## **⚠ WARNING**

Never tow people in or on any device except when towing a disabled vehicle with operable brakes and steering or on a trailer designed for passengers that has a rigid tow bar.

## **Transporting**

When transporting, the vehicle must be in its normal operating position (on all four wheels) and the following procedure must be used:

1. Place the transmission in park.

## **CAUTION**

Failure to place the transmission in park could allow the vehicle to roll off the trailer in the event of tie-down strap failure.

2. Secure the vehicle with load rated hold-down straps.

■ **NOTE:** Use front tow hook option (A) if equipped. Use bumper brackets behind bumper option (B) if tow hooks are unavailable.



MOD156



MOD728



■ **NOTE:** Suitable hold-down straps are available from an authorized dealer. Ordinary rope is not recommended because it can stretch under load.

### CAUTION

If using additional hold-down straps in any other areas, care must be taken not to damage the vehicle.

### ⚠ WARNING

Never secure a strap across the floorboard of the vehicle.

### CAUTION

Always latch the doors when transporting to prevent damage to the doors and body panels.

## Gas — Oil — Lubricant

### Filling Gas Tank

### ⚠ WARNING

Always fill the gas tank in a well-ventilated area. Never add gasoline to the gas tank near any open flames or with the engine running or hot. **DO NOT SMOKE** while filling the gas tank.

Since gasoline expands as its temperature increases, the gas tank must be filled to its rated capacity only. Expansion room must be maintained in the tank particularly if the tank is filled with cold gasoline and then moved to a warm area.

Allow the engine to cool before filling the gas tank. Care must be taken not to overfill the tank. If overfilled, gas may leak onto the engine creating a fire hazard.



MOD080A

### ⚠ WARNING

Do not overflow gas when filling the gas tank. A fire hazard could materialize. Always allow the engine to cool before filling the gas tank.

Tighten the gas tank cap securely after filling the tank.

### ⚠ WARNING

Do not overfill the tank.

### Recommended Gasoline

The recommended gasoline to use in this vehicle is 87 minimum octane regular unleaded. In many areas, oxygenates are added to the gasoline. Oxygenated gasolines containing up to 10% ethanol or 5% methanol are acceptable gasolines.

When using ethanol-blended gasoline, it is not necessary to add a gasoline antifreeze since ethanol will prevent the accumulation of moisture in the fuel system.

### CAUTION

Do not use white gas. Only approved gasoline additives should be used.

### Recommended Engine Oil

### CAUTION

Any oil used in place of the recommended oil could cause serious engine damage. Do not use oils which contain graphite or molybdenum additives. These oils can adversely affect clutch operation. Also, not recommended are racing, vegetable, non-detergent, and castor-based oils.

The recommended oil to use is synthetic engine oil, which has been specifically formulated for use in the engine. Although synthetic engine oil is the only oil recommended for use in this engine, use of any API-certified SM 0W-40 oil is acceptable.

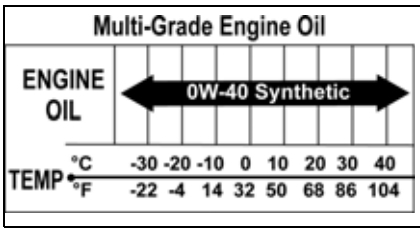

OILCHARTJ

## Recommended Transaxle Lubricant

■ **NOTE:** TRACKER OFF ROAD recommends the use of manufacturer-approved lubricants.

The recommended transaxle lubricant is transaxle fluid with EP. This meets all the lubrication requirements of this vehicle.

## Recommended Front Differential Lubricant

■ **NOTE:** TRACKER OFF ROAD recommends the use of manufacturer-approved lubricants.

The recommended front differential lubricant is SAE-approved 80W-90 hypoid. This meets all the lubrication requirements of this vehicle.

### CAUTION

Any lubricant used in place of the recommended lubricant could cause serious front differential/rear drive damage.

## Engine Break-In

After the completion of the break-in period, the engine oil and oil filter should be changed. Other maintenance after break-in should include checking of all prescribed adjustments and tightening of all fasteners. At the discretion and expense of the owner/operator, the vehicle may be taken to an authorized dealer for this initial service.

New vehicles and engines require a “break-in” period. The first month is most critical to the life of this vehicle. Proper operation during this break-in period will help ensure maximum life and performance from this vehicle.

When the engine starts, allow it to warm up properly. Idle the engine several minutes until the engine has reached normal operating temperature. Do not idle the engine for excessively long periods of time.

During the first 2.5 hours of operation, always use less than 40% throttle. For the second 2.5 hours of operation, operate at 40-60% with short-term use up to WOT (wide-open throttle). Varying the engine RPM during the break-in period allows the components to “load” (aiding the engine/transmission component mating process) and then “unload” (allowing components to cool). Although it is essential to place some stress on the engine components during break-in, care should be taken not to overload the engine too often.

## Burnishing Brake Pads

Brake pads must be burnished to achieve full braking effectiveness. Braking distance will be extended until brake pads are properly burnished.

### ⚠ WARNING

Do not attempt sudden stops or put yourself into a situation where a sudden stop will be required until the brake pads are properly burnished.

1. Choose an area large enough and level enough to safely accelerate the vehicle to 30 mph (48 km/h) and to decelerate to 5 mph (0-8 km/h).
2. Accelerate to 30 mph (48 km/h); then release the accelerator pedal and lightly depress the brake pedal to decelerate to 5 mph (0-8 km/h).

■ **NOTE:** It should take about 5 seconds to decelerate to 5 mph (8 km/h) with light braking.

3. Allow brakes to cool between cycles by cruising at 10 mph (16 km/h) for 1 minute.
4. Repeat procedure 10 times.

■ **NOTE:** Avoid coming to a complete stop during the procedure, or uneven distribution of brake pad material on the rotors may occur, resulting in uneven braking performance. If a complete stop is necessary, rather than locking the brakes while stopping, slow down the vehicle enough that the vehicle rolls to a complete stop without applying the brakes.

## **General Maintenance**

■ **NOTE:** Proper maintenance of this vehicle is important for optimum performance. Follow the Maintenance Schedule and all ensuing maintenance instructions/information.

If, at any time, abnormal noises, vibrations, or improper functioning of any component of this vehicle is detected, DO NOT OPERATE THE VEHICLE. Take the vehicle to an authorized dealer for inspection and adjustment or repair.

If the owner/operator does not feel qualified to perform any of these maintenance procedures or checks, take the vehicle to an authorized dealer for professional service.

■ **NOTE:** The following instructions and information refer to specific items in the maintenance and care of this vehicle.

<b>Maintenance Schedule</b>			
<b>Period</b>	<b>Check/Inspect</b>	<b>Replace</b>	<b>Clean</b>
<b>Daily</b>	See Pre-Start/Pre-Operation Checklist		
<b>Break-In</b>			
First 10 hours/100 miles (160 km)	-Wheel lug nuts (torque to 100 ft-lb [136 N-m])		
First 50 hours/500 miles (800 km)	-Wheel lug nuts (torque to 100 ft-lb [136 N-m]) -Fluid levels	-Transaxle fluid -Front differential fluid -Engine oil and filter	
<b>Recurring</b>			
Every 100 hours/1000 miles (1600 km)	-Fluid levels -Rear knuckles (grease) -Engine air filter outer element	-Engine air filter outer element, replace as necessary	
Every 200 hours/2000 miles (3200 km)	-Brake pad wear* -All hardware, tighten if necessary -Battery terminals -Spark arrestor -Drive and driven clutch -Sway bar links and bushings -CVT belt -CVT air inlet -Wheel lug nuts (torque to 100 ft-lb [136 N-m]) -Spark plugs, check gap -Clutch engagement RPM (approx. 1200- 1300 RPM) -Shocks/springs	-Engine oil and filter -Alternator belt -Spark arrestor, replace as necessary -Drive and driven clutch, replace worn components as necessary -Sway bar links and bushings, replace as necessary -CVT belt, replace as necessary -Spark plugs, replace as necessary	-Radiator -Battery terminals -Spark arrestor -Drive and driven clutch -CVT air inlet -Spark plugs -Drive and driven clutch (blow out with compressed air) -Shocks/springs
Every 400 hours/4000 miles (6400 km)	-Rubber lines and hoses -Engine air filter inner element -Engine air filter intake hose	-Transaxle fluid -Front differential fluid -Rubber lines and hoses, replace as necessary -Engine air filter inner element, replace as necessary	-Engine air filter intake hose
Every 500 hours/5000 miles (8000 km)	-Valve lash clearance*		
Every 24 months		-Brake fluid -Engine coolant	
Every 6 months	-Proper door latching	-Add shims as needed.	

\* Dealer maintenance

## Liquid Cooling System

■ **NOTE:** Debris in the engine compartment or packed between the cooling fins of the radiator can reduce cooling capability. Using a garden hose, wash the radiator to remove any debris preventing air flow.

### CAUTION

Do not use a pressure washer to clean the radiator core. The pressure may bend or flatten the fins causing restricted air flow, and electrical components on the radiator could be damaged. Use only a garden hose with spray nozzle at normal tap pressure.

The cooling system capacity can be found in the specification chart. The cooling system should be inspected daily for leakage and damage. If leakage or damage is detected, take the vehicle to an authorized dealer for service. Also, the coolant level should be checked periodically.

### CAUTION

Continued operation of the vehicle with high engine temperature may result in engine damage or premature wear.

■ **NOTE:** High engine RPM, low vehicle speed, or heavy load can raise engine temperature. Decreasing engine RPM, reducing load, and selecting an appropriate transmission gear can lower the temperature.

### ⚠ WARNING

Never check the coolant level when the engine is hot or the cooling system is under pressure.

When filling the cooling system, use a coolant/water mixture of 60/40 or a coolant/water mixture which will satisfy the coldest anticipated weather conditions of the area in accordance with the coolant manufacturer's recommendations.

Always maintain the coolant level at the cold fill line of the coolant reservoir.

## Checking Coolant

1. Lift the hood by turning the 1/4-turn fasteners located at the rear of the hood. Remove the hood by sliding it toward the rear of the vehicle and out of the slots in the grill.

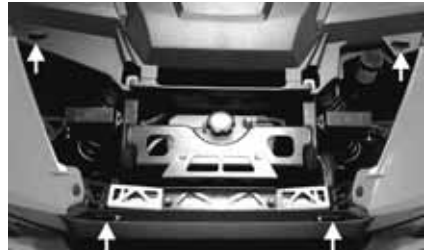

MOD044A

2. Inspect the coolant level cold. The level shouldn't be lower than the cold full line. When it's at operating temperature, the coolant level may be above the cold full line.



MOD043

■ **NOTE:** If you cannot see any coolant in the reservoir, inspect the cooling system for leaks. If no leaks are present, add coolant using the bleed procedure below. If a coolant leak is suspected, schedule service with an authorized dealer.

## Bleeding Cooling System

While the cooling system is being filled, air pockets may develop; therefore, make sure the cooling system is properly bled, with no trapped air in the system.

1. Slowly remove the plug from the top of the thermostat housing on the left side of the engine allowing trapped air to escape.

- When pure coolant (no air) flows from the bleed hole, install the bleed plug and tighten securely.
- Fill the cooling system to the cold fill line of the reservoir. Run the engine for five minutes after the initial fill; then shut off the engine and recheck coolant level once cool.

The front shock absorbers or front and rear shock absorbers have an adjustment sleeve with three preload adjustment positions that can be turned with a special spanner wrench to increase or decrease coil spring tension.

■ **NOTE:** The softest setting is as shown.



MOD152A

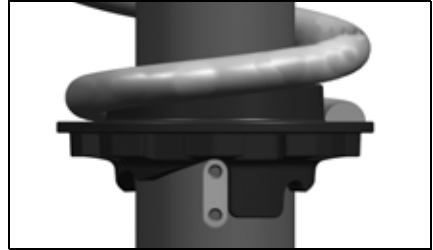

MOD725

■ **NOTE:** Use a good quality, biodegradable glycol-based, automotive-type antifreeze.

### CAUTION

After operating the vehicle for the initial 5-10 minutes, stop the engine, allow the engine to cool down, and check the coolant level. Add coolant as necessary.

■ **NOTE:** Before attempting to adjust suspension, clean dirt and debris from the sleeve and remove load from the suspension. Using a suitable lift or jack, lift the vehicle enough to allow the shock assembly to fully extend. Use the spanner wrench to adjust the sleeve to the desired position.

## Shock Absorbers

Each shock absorber should be visibly checked weekly for excessive fluid leakage (some seal leakage may be observed but it does not indicate the shock is in need of replacement), cracks or breaks in the lower case, or a bent shock rod. If any one of these conditions is detected, replacement is necessary.

To adjust the spring force on these shock absorbers, rotate the preload adjustment sleeve with a suitable spanner wrench until desired spring tension is achieved.

■ **NOTE:** When the vehicle is operated in extremely cold weather (-23° C/-10° F or colder), a small amount of leakage may be present. Unless the leakage is excessive, replacement is not necessary.

Position	Spring Force	Setting	Load
1	↓ Stronger	↑ Soft	↑ Light
2		↕ Stiff	↕ Heavy
3		↓ Stiff	↓ Heavy

This vehicle is equipped with adjustable shock absorbers in the front and rear to allow for different driving and loading conditions.

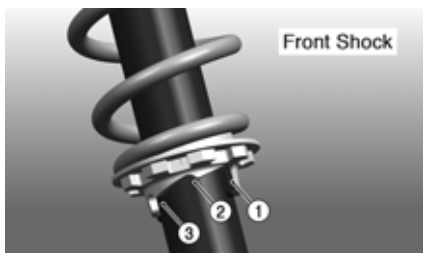

MOD727

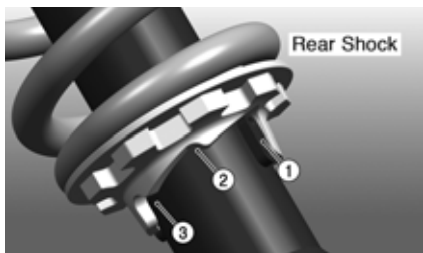

MOD726

## General Lubrication Cables

None of the cables require lubrication; however, it is advisable to lubricate the ends of the cables periodically with a good cable lubricant.

## Cargo Box Latches

Periodically apply a light coat of grease to the latches and pins. Do not over grease.

## Engine Oil and Filter

■ **NOTE:** Refer to the recommended oil viscosity chart on page 40 in this manual for the proper engine oil.

■ **NOTE:** Refer to the oil level stick on page 37 in this manual for the location and proper way to check oil.

Change the engine oil and oil filter at the scheduled intervals. The engine should always be warm when the oil is changed so the oil will drain easily and completely.

1. Park the vehicle on level ground.
2. Remove the middle seat; then remove the maintenance cover to access the oil filter.

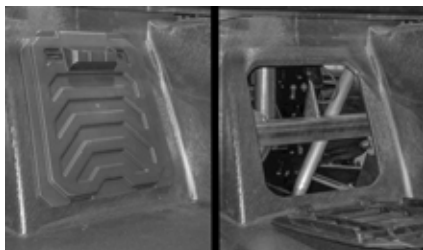

MOD105

3. Tilt the cargo box to the dump position; then loosen the oil fill cap. Be careful not to allow contaminants to enter the opening.



MOD064

4. Remove the drain plug from the bottom of the engine and drain the oil into a drain pan.

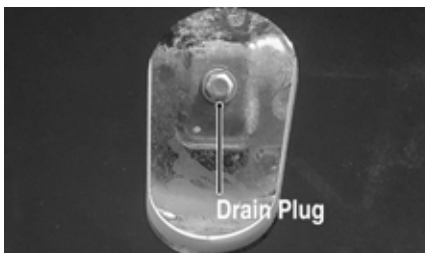

MOD020A

5. Using the oil filter wrench and a ratchet handle (or a socket or box-end wrench), remove the old oil filter and dispose of properly. Capture oil in a suitable pan or absorbent material. Do not reuse oil filter.



MOD106

■ **NOTE:** Clean up any excess oil after removing the filter.

6. Apply oil to the new filter O-ring and check to make sure it is positioned correctly; then install the new oil filter and tighten to 14.8-18.4 ft-lb (20-25 N-m).
7. Install the engine drain plug and tighten to 36.9 ft-lb (50 N-m). Pour the recommended oil into the filler hole. Install oil fill cap.
8. Start the engine (while the vehicle is outside on level ground) and allow it to idle for a few minutes.
9. Turn the engine off and wait approximately one minute. Recheck the oil level.
10. Inspect the area around the drain plug and oil filter for leaks.
11. Install the maintenance cover and middle seat.
12. Check to make sure the oil fill cap is secure and the oil level stick is installed correctly; then lower the cargo box to its locked down position.

### **Front Differential/ Transaxle Lubricant (Inspecting/Changing)**

Inspect and change the lubricant in each according to the Maintenance Schedule. When changing the lubricant, use the appropriate lubricant and use the following procedure:

1. Place the vehicle on level ground; then remove the fill plugs: (A) front differential and (C) transaxle.



MOD073A



MOD058A

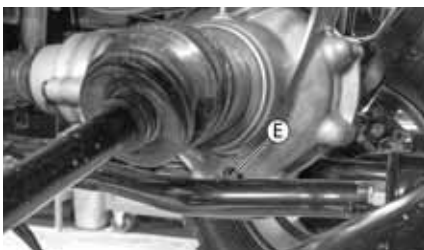

MOD126A

2. Drain the oil into a drain pan by removing the drain plugs: (E) right-side front differential and (D) transaxle.



MOD073A





MOD058A

- After the oil has been drained, install the drain plugs and tighten to 45 in-lb (5 N-m) (front differential) and 16 ft-lb (21.8 N-m) (transaxle).

### CAUTION

Inspect the oil for any signs of metal filings or water. If found, take the vehicle to an authorized dealer for servicing.

- Pour recommended quantity and type of oil into each fill hole:
  - (A) Front differential fill plug: Add lube until it is level with (B) fill level plug.
  - (C) Transaxle fill and fill level plug: Add lube until it is level with the bottom of (C).
- Install the fill plugs and tighten to 16 ft-lb (21.8 N-m).

## Hydraulic Brake

### WARNING

Be sure to inspect the hydraulic brake system before each use. Always maintain brakes according to the Maintenance Schedule.

### Brake Fluid



MOD705

- Check the brake fluid level in the brake fluid reservoir. The fluid level must be maintained between the MAX and MIN level marks. If the level in the reservoir is low, add DOT 4 brake fluid.

■ **NOTE:** The brake fluid reservoir is located under the hood.

- Press the brake pedal several times to check for firmness.
- If the pedal is not firm, take the vehicle to an authorized dealer.

### CAUTION

Be careful not to spill any fluid when filling the brake fluid reservoir. Wipe away spilled fluid immediately.

### Brake Hoses

Carefully inspect the hydraulic brake hoses for cracks or other damage. If found, take the vehicle to an authorized dealer to have the brake hoses replaced.

### Brake Pads

The clearance between the brake pads and brake discs is adjusted automatically as the brake pads wear. The only maintenance that is required is replacement of the brake pads when they show excessive wear. Check the thickness of each of the brake pads as follows:

- Remove a front wheel.
- Measure the thickness of each brake pad.
- If thickness of either brake pad friction material is less than 0.5 mm (0.019 in), take the vehicle to an authorized dealer to have brake pads replaced.

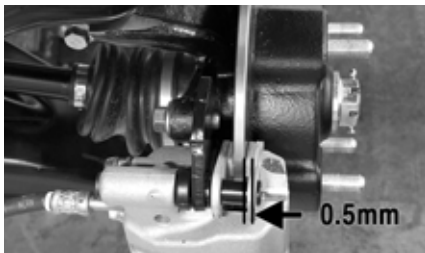

MOD081A

4. Install the wheel and tighten the wheel nuts in 25 ft-lb (34 N-m) increments to a final torque of 100 ft-lb (136 N-m).

■ **NOTE:** Whenever the wheels are removed and installed onto the hub and the lug nuts are tightened, refer to the Maintenance Schedule found on page 42 to identify the appropriate service interval requiring the tightening of the lug nuts.

## Fuel Hoses

Inspect the fuel hoses. Damage from aging may not always be visible.

## Protective Rubber Boots

The protective boots should be inspected periodically according to the Maintenance Schedule.

## Ball Joint Boots (Upper and Lower/Right and Left)



MOD094A

1. Secure the vehicle on a support stand to elevate the front wheels.
2. Remove both front wheels.
3. Inspect the four ball joint boots for cracks, tears, or perforations.
4. Check the ball joint for free-play by grasping the steering knuckle and turning it from side to side and up and down.
5. If boot damage is present or ball joint free-play seems excessive, contact an authorized dealer for service.

## Tie Rod Boots (Inner and Outer/Right and Left)



MOD071B

1. Secure the vehicle on a support stand to elevate the front wheels.
2. Remove both front wheels.
3. Inspect the four tie rod boots for cracks, tears, or perforations.
4. Check the tie rod end free-play by grasping the tie rod near the end and attempting to move it up and down.
5. If boot damage is present or tie rod end free-play seems excessive, contact an authorized dealer for service.

## Drive Axle Boots



CC793

1. Inspect all drive axle boots for cracks, tears, or perforations.
2. If boot damage is present, contact an authorized dealer for service.

## Rear Knuckle Grease Zerks

There are four grease Zerk fittings on the vehicle — two on each rear knuckle. They can be accessed from the rear of the vehicle.



#### MOD176

Inspect and add grease in each Zerk according to the Maintenance Schedule.

1. Clean any dirt or debris from the Zerk before adding grease.
2. Add grease to the Zerk until any trapped air or moisture is pushed out.

**NOTE:** Under normal use 2-3 pumps of the grease gun is all that will be needed.

**NOTE:** Adding more grease than needed may damage the seals. Adding grease until clean grease is visible is not necessary.

3. Wipe any excess grease from the Zerks and seals to prevent dirt and debris from accumulating.

## Battery

The battery is located in a compartment in front of the right-rear wheel.

After being in service, batteries require regular cleaning and recharging in order to deliver peak performance and maximum service life. The following procedures are recommended for cleaning and maintaining lead-acid batteries. Always read and follow instructions provided with battery chargers and battery products.

**NOTE:** Refer to all warnings and cautions provided with the battery or battery maintainer/charger.

Loss of battery charge may be caused by ambient temperature, ignition OFF current draw, corroded terminals, self discharge, frequent start/stops, and short engine run times. Frequent winch usage, snowplowing, extended low RPM operation, short trips, and high amperage accessory usage are also reasons for battery discharge.

## Maintenance Charging

**NOTE:** The manufacturer recommends the use of the CTEK Multi US 800 or the CTEK Multi US 3300 for battery maintenance charging. Maintenance charging is required on all batteries not used for more than two weeks or as required by battery drain.

1. When charging a battery in the vehicle, be sure the ignition switch is in the OFF position.

**NOTE:** Be sure to maintain the fluid of the battery at the UPPER LEVEL. Use only distilled water when adding fluid to these batteries.

2. Clean the battery terminals with a solution of baking soda and water.
3. Be sure the charger and battery are in a well-ventilated area and ensure the battery charger cables will not contact any battery acid. Be sure the charger is unplugged from the 110-volt electrical outlet.
4. Connect the red terminal lead from the charger to the positive terminal of the battery; then connect the black terminal lead of the charger to the negative terminal of the battery.

**NOTE:** Optional battery charging adapters are available from an authorized dealer to connect directly to your vehicle from the recommended chargers to simplify the maintenance charging process. Check with an authorized dealer for proper installation of these charging adapter connectors.

5. Plug the battery charger into a 110-volt electrical outlet.
6. If using the CTEK Multi US 800, there are no buttons to push. If using the CTEK Multi US 3300, press the Mode button (A) on the left side of the charger until the Maintenance Charge Icon (B) at the bottom illuminates. The Normal Charge Indicator (C) should illuminate on the upper portion of the battery charger.



800D

■ **NOTE:** The maintainer/charger will charge the battery to 95% capacity at which time the Maintenance Charge Indicator (D) will illuminate and the maintainer/charger will change to pulse/float maintenance. If the battery falls below 12.9 DC volts, the charger will automatically start again at the first step of the charge sequence.

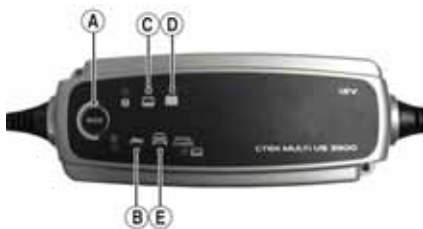

3300D

■ **NOTE:** Not using a battery charger with the proper float maintenance will damage the battery if connected over extended periods.

## Charging

■ **NOTE:** The manufacturer recommends the use of the CTEK Multi US 800 or the CTEK Multi US 3300 for battery maintenance charging.

1. Be sure the battery and terminals have been cleaned with a baking soda and water solution.
2. Be sure the charger and battery are in a well-ventilated area and ensure the battery charger cables will not contact any battery acid. Be sure the charger is unplugged from the 110-volt electrical outlet.

3. Connect the red terminal lead from the charger to the positive terminal of the battery; then connect the black terminal lead of the charger to the negative terminal of the battery.
4. Plug the charger into a 110-volt electrical outlet.
5. By pushing the Mode button (A) on the left side of the charger, select the Normal Charge Icon (E). The Normal Charge Indicator (C) should illuminate on the upper left portion of the charger.
6. The battery will charge to 95% of its capacity at which time the Maintenance Charge Indicator (D) will illuminate.

■ **NOTE:** For optimal charge and performance, leave the charger connected to the battery for a minimum 1 hour after the Maintenance Charge Indicator (D) illuminates. If the battery becomes hot to the touch, stop charging. Resume after it has cooled.

7. Once the battery has reached full charge, unplug the charger from the 110-volt electrical outlet.

■ **NOTE:** If, after charging, the battery does not perform to operator expectations, bring the battery to an authorized dealer for further troubleshooting.

## Jump-Starting

■ **NOTE:** DO NOT jump-start a vehicle with a dead battery. Instead, remove the battery, service it, and correctly charge it. In an emergency, however, it may be necessary to jump-start a vehicle. If so, use the following procedure to carefully and safely complete this procedure.

### **WARNING**

Improper handling or connecting of a battery may result in serious injury including acid burns, electrical burns, or blindness as a result of an explosion. Always remove rings and watches.

1. On the vehicle to be jump-started, remove the battery cover and any terminal boots.

### **⚠ WARNING**

Any time service is performed on a battery, the following must be observed: keep sparks, open flame, cigarettes, or any other flame away. Always wear safety glasses. Protect skin and clothing when handling a battery. When servicing a battery in enclosed space, keep the area well-ventilated. Make sure battery venting is not obstructed.

2. Inspect the battery for any signs of electrolyte leaks, loose terminals, or bulging sides. Leaking or bulging battery cases may indicate a frozen or shorted battery.

### **⚠ WARNING**

If any of these conditions exist, DO NOT attempt a jump-start, boost, or charge the battery. An explosion could occur causing serious injury or death.

3. Inspect the vehicle to be used for the jump-start to determine if voltage and ground polarity are compatible. The vehicle must have a 12-volt DC, negative ground electrical system.

### **CAUTION**

Always make sure the electrical systems are of the same voltage and ground polarity prior to connecting jumper cables. If not, severe electrical damage could occur.

4. Move the vehicle to be used for the jump-start close enough to ensure the jumper cables easily reach; then shift into neutral, set and lock the brakes, shut off all electrical accessories, and turn the ignition switch OFF.

■ **NOTE:** Make sure all switches on the vehicle to be jump-started are turned OFF.

5. Disconnect all external accessories such as cell phones, GPS units, and radios on both vehicles.

### **CAUTION**

Failure to disconnect electronic accessories during jump-starting may cause system damage due to power spikes.

6. Attach one clamp of the positive (red) jumper cable to the positive (+) terminal (1) of the dead battery (C) being careful not to touch any metal with the other clamp; then attach the other clamp of the positive (red) jumper cable to the positive (+) terminal (2) of the good battery (B).

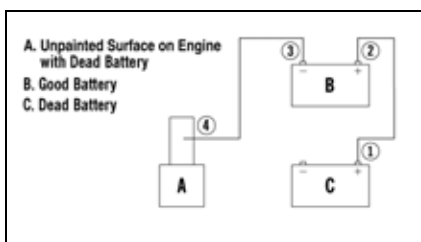

0744-527

■ **NOTE:** Some jumper cables may be the same color but the clamps or ends will be color-coded red and black.

7. Attach one clamp of the negative (black) jumper cable to the negative (-) terminal (3) of the good battery (B); then attach the other clamp of the negative (black) jumper cable (4) to an unpainted metal surface (A) on the engine or frame well away from the dead battery and fuel system components.

### **⚠ WARNING**

Never make the final connection to a battery as a spark could ignite hydrogen gases causing an explosion of the battery resulting in acid burns or blindness.

8. Stand well away from the dead battery and start the vehicle with the good battery. Allow the vehicle to run for several minutes applying some charge to the dead battery.

9. Start the vehicle with the dead battery and allow it to run for several minutes before disconnecting the jumper cables.
10. Remove the jumper cables in opposite order of hook-up (4, 3, 2, 1). Be careful not to short cables against bare metal.

■ **NOTE:** Have the battery and electrical system checked prior to operating the vehicle again.

## Spark Plug(s)

This vehicle comes equipped with a specified spark plug. See the Specifications chart for the correct spark plug. A light brown insulator indicates that the plug is correct. A white or dark insulator indicates that the engine may need to be serviced. Consult an authorized dealer if the plug insulator is not a light brown color. To help prevent cold weather fouling, make sure to thoroughly warm up the engine before operating.

To maintain a hot, strong spark, keep the plug free of carbon.

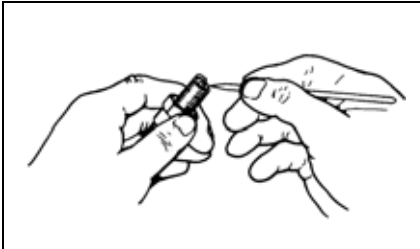

ATV-0051

Before removing the spark plug, be sure to clean the area around the spark plug. If you do not, dirt could enter the engine when removing or installing the spark plug.

Adjust the spark plug gap (see Specifications chart) for proper ignition. Use a feeler gauge to check the gap.

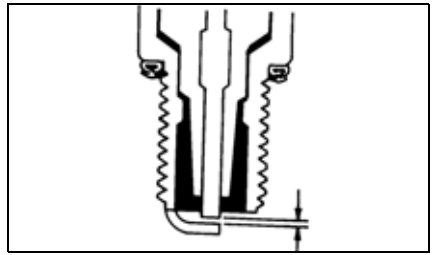

ATV-0052

Tighten spark plug to 14.75 ft-lb (20 N-m).

## CVT Air Inlet

This vehicle is equipped with an air inlet to collect air for the Continuously Variable Transmission (CVT).

■ **NOTE:** When servicing clutches or belt, it is recommended to inspect and clean the CVT air inlet.

1. Remove the left access panel; loosen the clamp that holds the snorkel portion to the air inlet.



MOD205

2. Disconnect snorkel portion from air inlet; clean and inspect.
3. Install the snorkel to the air inlet and tighten the clamp securely. Reinstall the left access panel.

## Primary Air Filter/Safety Filter/Clean-out Valve

The engine air filter inside the air filter housing must be kept clean to provide good engine power and fuel mileage. If the vehicle is used under normal conditions, service the filter at the intervals specified. If operated in dusty, wet, or muddy conditions, inspect and service the filter more frequently. Use the following procedure to clear the clean-out valve, remove the primary filter and safety filter, and inspect and/or clean them.

### CAUTION

Failure to inspect the air filter frequently if the vehicle is used in dusty, wet, or muddy conditions can damage the engine.

■ **NOTE:** To access the air filter housing, the right side access panel must be removed and the cargo box raised if desired.

### Air Filter Removal and Inspection

1. Remove dirt and debris from around the air filter housing cover; then squeeze the clean-out valve to clear it of any accumulated dirt or dust.
2. Check the clean-out valve for cracks or damage. Replace as needed.



MOD085

3. Pull out on the orange air filter housing cover lock; then turn the air filter housing cover counterclockwise to access the filter.



MOD084A



MOD084B

4. Remove the primary air filter element; then wipe the inside of the housing to remove dirt and debris.

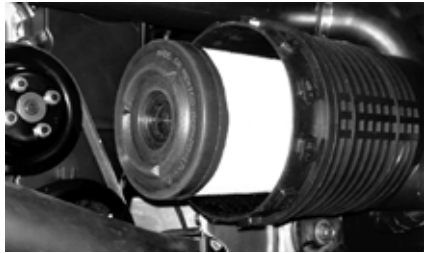

MOD086

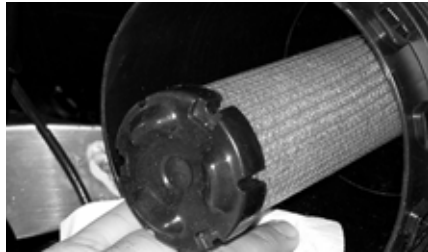

MOD087

5. Inspect the primary air filter element for damage or dirt. If damaged the filter must be replaced.

- A dust trail anywhere inside of the air filter housing, inlet tube or on the safety filter is a telltale sign of a leak. Leaks should be inspected by an authorized dealer.

### CAUTION

Do not attempt to clean the primary filter or filter damage may occur.

### CAUTION

When replacing the primary filter, always inspect the new filter for damage. Never install a damaged filter. Do not wipe the new filter as it is lubricated for sealing purposes.



MOD088



MOD089

- Remove and inspect the safety filter.

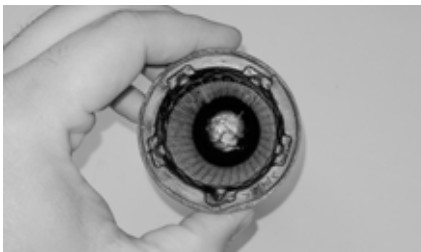

MOD090

## Air Filter Installation

- Install safety filter; then install the primary filter.

■ **NOTE:** The flower shape of the primary filter element must line up with the same-shaped void in the air filter housing for the air filter housing cover to fit properly.

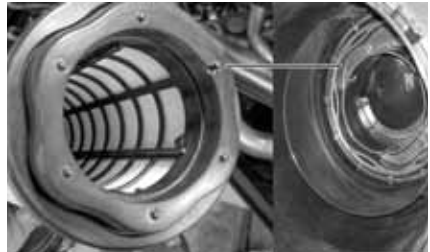

MOD091A

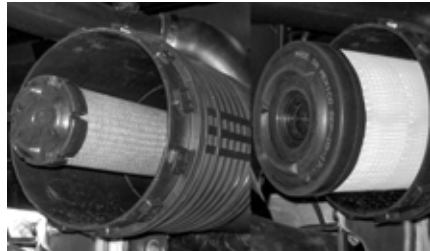

MOD092

- Install the air filter housing cover with the clean-out valve at the 5 o'clock position; then turn the air filter housing cover clockwise until it seats.

■ **NOTE:** The clean-out valve should be near the 6 o'clock position when the cover is seated.

- Lock the air filter housing cover.



MOD084C





MOD084A

4. Install the right access panel and secure with two 1/4-turn fasteners.



MOD247

### CAUTION

A torn air filter can cause damage to the engine. Dirt and dust may get inside the engine if the element is torn. Carefully examine the element for tears before and after cleaning it. Replace the element with a new one if it is torn.

## Tires

### WARNING

Always use the size and type of tires as specified. Refer to the specifications chart for proper tire inflation pressure, and always maintain proper tire inflation pressure.

## Tire Tread Condition

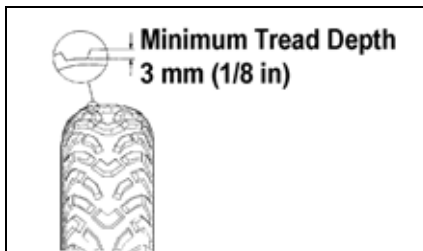

0732-649

The use of worn-out tires on this vehicle is very dangerous. A tire is considered to be worn out when the depth of the tread is less than 3 mm (1/8 in). Be sure to replace the tires before reaching this minimum specification.

### WARNING

The use of worn-out tires is dangerous and can increase the risk of an accident.

## Tire Replacement

This vehicle has low-pressure tubeless tires. Have this maintenance performed by a qualified tire repair station.

### WARNING

Replacement tires must be the same size as originally equipped. Refer to the Specifications table on page 20 for the original tire size. Failure to follow this warning can result in the vehicle being unstable and can cause errors in the vehicle's speedometer and odometer readings.

## Tubeless Tire Repair

Should a leak or flat tire occur due to a puncture, the tire may be repaired using a plug-type repair. If the damage is from a cut or if the puncture cannot be repaired using a plug, the tire must be replaced. When operating the vehicle in areas where transportation or service facilities are not readily available, it is strongly recommended to carry a plug-type repair kit and a tire pump.

## Wheels

1. Park the vehicle on level ground and place the gear selector in park.

- Loosen the lug nuts on the wheel to be removed.
- Elevate the vehicle.
- Remove the lug nuts.
- Remove the wheel.
- Install the wheel and install the lug nuts.
- Install the wheel and tighten the wheel nuts in 25 ft-lb (34 N-m) increments to a final torque of 100 ft-lb (136 N-m).
- Remove the jack.

■ **NOTE:** Whenever the wheels are removed and installed onto the hub and the lug nuts are tightened, refer to the Maintenance Schedule found on page 42 to identify the appropriate service interval requiring the tightening of the lug nuts.

### Muffler/Spark Arrester

The muffler has a spark arrester which must be periodically cleaned. At the intervals shown in the Maintenance Schedule, clean the spark arrester using the following procedure:

#### **WARNING**

Wait until the muffler cools to avoid burns.

- Remove the cap screw securing the spark arrester assembly to the muffler.

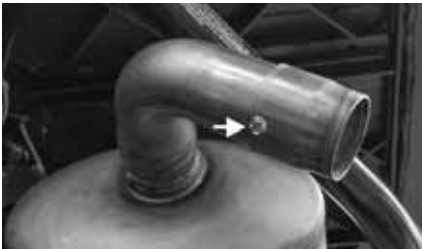

MOD095A

- Using a suitable brush, clean the carbon deposits from the screen taking care not to damage the screen.

■ **NOTE:** If the screen or gasket is damaged in any way, it must be replaced.

- Install the spark arrester assembly and secure with the cap screw. Tighten to 60 in-lb (6.8 N-m).

### Light Bulb Replacement

#### **CAUTION**

Use only specified bulbs indicated in the Specifications chart as replacement bulbs.

■ **NOTE:** The bulb portion of the headlight is fragile. **HANDLE WITH CARE.** When replacing the headlight bulb, do not touch the glass portion of the bulb. If the glass is touched, it must be cleaned with a dry cloth before installing. Skin oil residue on the bulb will shorten the life of the bulb.

To replace the headlight bulb, use the following procedure:

- Disconnect the wiring harness; then remove the rubber boot from the light assembly.

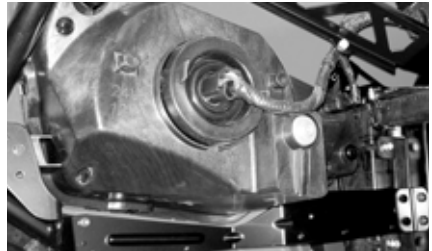

MOD046



MOD096

- Remove the old H4 bulb by unlocking the spring; then insert the new bulb into headlight assembly and lock the spring to secure the bulb.



MOD097A

3. Install the rubber boot making sure it is sealed around the bulb and connect the wire harness.



MOD098A

4. Adjust the headlight (see Checking/Adjusting Headlight Aim in this subsection).

### CAUTION

When replacing the headlight bulb, be careful not to touch the glass portion of the bulb. Grasp the new bulb with a clean rubber gloves.

### Taillight/Brake Light Assembly

If one or more individual LED bulbs are not working, the taillight/brake light assembly must be replaced.



MOD096

To replace the taillight/brake light assembly, use the following procedure:

1. Remove the four screws from the inner cargo box side panel, two rear tie-down screws and one tailgate latch bail screw; then remove the six screws from the underside of the cargo box and remove the outer cargo box side panel.



MOD114A



MOD115A

2. Remove screw (A); then flex the cargo box fender away from the cargo box to access and remove screw (B).

■ **NOTE:** A long extension with a socket or long screwdriver will be needed to access screw (B).

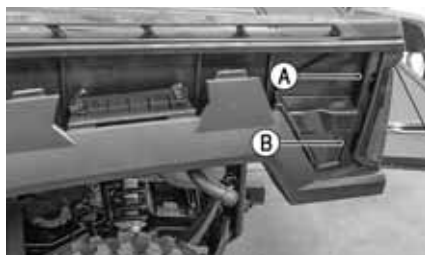

MOD117A

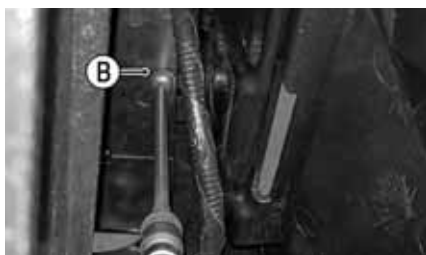

MOD113

3. Remove the taillight/brake light assembly and disconnect it from the harness by pushing on the connector lock.

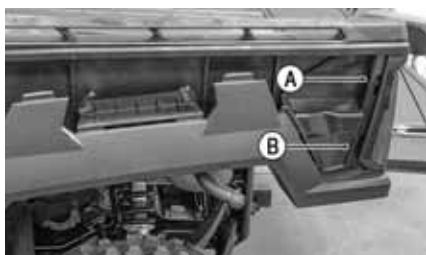

MOD117A



MOD110

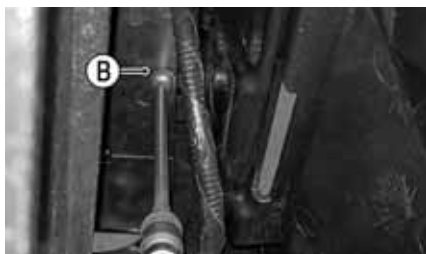

MOD113

6. Position the outer cargo box side panel behind the two tabs on the cargo box fender; then fit all tabs into their adjoining slots in the side panel



MOD112A

4. Install the new assembly making sure to connect the harness.



MOD116A

7. With a suitable pry bar, lift up on the outer cargo box floor near the rear corner.



MOD112

5. Install screw (A) first; then flex the cargo box fender away from the cargo box to access and install screw (B).



MOD110A

- Start at the rear of the cargo box and tuck the outer side panel under the cargo box and work it into place from back to front.

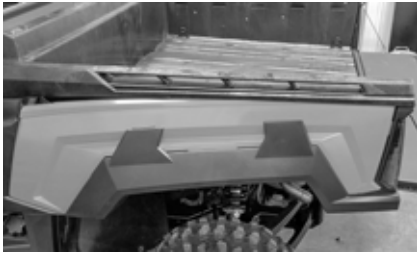

MOD111

- Once the outer side panel is in place, install the screws securing the cargo box fender and outer side panel.

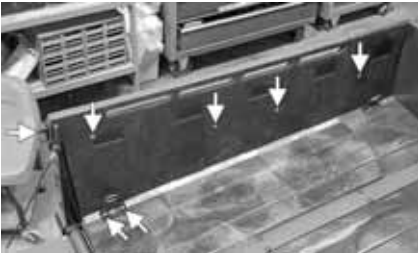

MOD114A



MOD115A

## Checking/Adjusting Headlight Aim

The headlights can be adjusted vertically. The geometric center of the HIGH beam light zone is to be used for aiming.

- Position the vehicle on a level floor so the headlights are approximately 6.1 m (20 ft) from an aiming surface (wall or similar aiming surface).



MOD038

■ **NOTE:** There should be an average operating load on the vehicle when adjusting the headlight aim.

- Measure the distance from the floor to the midpoint of each headlight.
- Using the measurements obtained in step 2, make horizontal marks on the aiming surface directly in front of the headlights.
- Make vertical marks which intersect the horizontal marks on the aiming surface directly in front of the headlights.
- Switch on the lights. Make sure the HIGH beam is on. DO NOT USE LOW BEAM.
- Observe each headlight beam aim. Proper aim is when the most intense beam is centered on the vertical mark 5 cm (2 in) below the horizontal mark on the aiming surface.
- With a 10 mm wrench, turn the headlight adjuster clockwise to adjust the beam down or counterclockwise to adjust the beam up.



MOD046A

## Fuses

The fuses are located in two Power Distribution Modules (PDM) under the hood. If there is any type of electrical system failure, always check the fuses first.



MOD044B

■ **NOTE:** To remove the fuse, compress the locking tabs on either side of the fuse cover and lift out.



6411-493

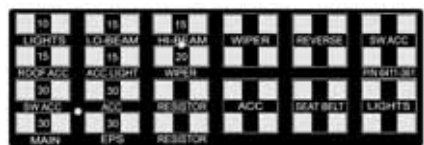

6411-361

■ **NOTE:** Spare fuses are located inside the fuse cover.

### CAUTION

Always replace a blown fuse with a fuse of the same type and rating. If the new fuse blows after a short period of use, consult an authorized dealer immediately.

## Electrical Output Terminals

Three output terminals for electrical accessories are located on the front and rear wiring harnesses. Two accessory plugs are located on the dashboard.

■ **NOTE:** The front output terminals are located behind the LCD information gauge. The rear output terminal is located beneath cargo box.

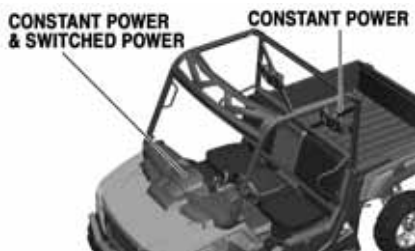

MOD099Ad

## Switched Accessory Power

Switched power is battery power, turned on by the ignition switch, either in the run or start position. Battery power is terminated when the ignition switch is turned off. One switched power output terminal is located under the dashboard behind the LCD information gauge. Orange/black is positive and black is negative. Switched power is ideal for accessories the operator wants on any time the ignition key is in the run position.

## Constant Accessory Power

Constant power is direct battery power. Battery power can only be terminated by removing the 30-amp main fuse. One constant power output terminal is located under the dashboard behind the LCD information gauge and one constant power output terminal is located beneath the cargo box on the passenger side. Red/white is positive and black is negative. Constant power is ideal for accessories the operator wants to control with accessory on/off switches when needed.

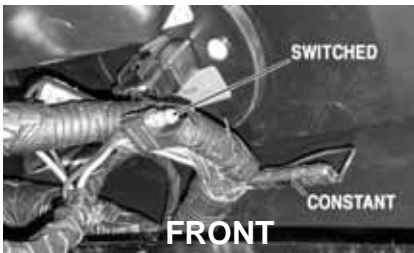

MOD100A



MOD103A

To open the dashboard storage compartment, lift up on the lock arm and open toward the vehicle occupant.

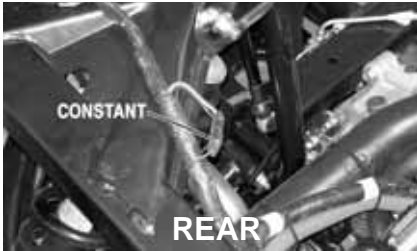

MOD101A



MOD044A

### CAUTION

Always use electrical accessories less than 30 amps (Accessory Fuse).

## Storage Compartments/Tools

This vehicle has a storage compartment within the dashboard and a tool storage compartment beneath the hood. To access the compartment located under the hood, turn the two 1/4-turn fasteners at the rear of the hood and tilt the hood forward; then slide the hood toward the rear of the vehicle.

A basic tool kit is provided in the tool storage compartment. Maintain the tool kit with the vehicle at all times.



MOD044A

## Seat Belts

Inspect the seat belts for damage, and frayed or torn edges. Check that the belts extend and retract smoothly and fully without binding or catching. Check that the latch plate locks securely in the buckle and releases when the button is depressed. Ensure retractors are free of dirt and/or debris. Do not grease or oil the retractors.

### ⚠ WARNING

If the seat belt(s) are damaged, frayed, or torn, belt(s) must be replaced.

## Doors

Inspect the doors and latches for corrosion, loose hardware and damage.

### ⚠ WARNING

Do not remove the doors. Removing the doors increases the risk of serious injury or death.

## Adjusting Doors

■ NOTE: Door Adjustment will vary depending on striker plate and door latch vehicle is equipped with.

1. Door adjustment is accomplished by loosening the striker plate screws; then moving the striker plate up, down, side to side, on the slotted holes. When desired latching/unlatching is obtained, tighten cap screws.



MOD279



MOD736

## Occupant Shoulder Restraints

Inspect the occupant shoulder restraints for damage or loose hardware.

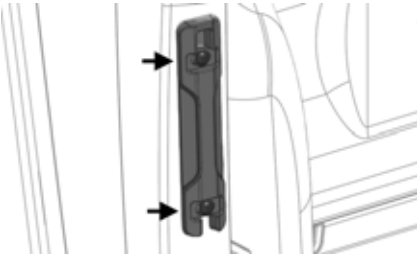

MOD734

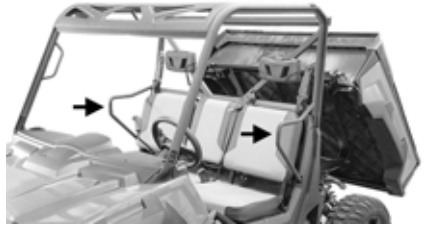

MOD009B

2. The following door latch option can also be adjusted for depth by removing screws and striker plate (A) and adding shims (B) as needed.

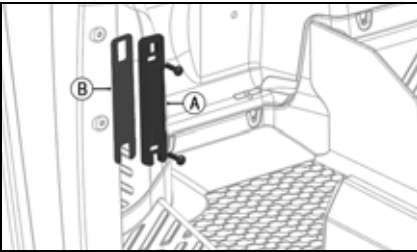

MOD735

3. Adjust striker plate depth to ensure latch rod has enough engagement with striker plate cut out (A) to secure door when handle is in closed position. Minimum recommended depth is entire chamfered tip of latch rod. (B).

## **WARNING**

**Do not remove the occupant shoulder restraints. Removing the shoulder restraints increases the risk of serious injury or death.**

## **ROPS**

Inspect the Rollover Protection Structure (ROPS) for any deformation, damage, improper installation, loose or missing fasteners, modifications, drilling, repair, welding and/or a missing label. If any of these circumstances are discovered, do not operate and immediately bring the vehicle to an authorized dealer for service.



## Preparation for Storage

Use the following procedure to prepare the vehicle for storage:

### CAUTION

**Prior to storing this vehicle, it must be properly serviced to prevent rusting and component deterioration.**

1. Clean the vehicle thoroughly by washing dirt, oil, grass, and other foreign matter from the entire vehicle. Allow the vehicle to dry thoroughly. **DO NOT** get water into any part of the engine or air intake.
2. Either drain the gas tank or add a fuel stabilizer to the gas in the gas tank.
3. Clean the interior of the air filter housing.
4. Plug the hole in the exhaust system with steel wool.

5. Tighten all nuts, bolts, cap screws, and screws. Make sure rivets holding components together are tight. Replace all loose rivets. Care must be taken that all calibrated nuts, cap screws, and bolts are tightened to specifications.

6. Fill the cooling system to the cold fill line with properly mixed coolant.

7. Disconnect the battery cables (negative cable first); then remove the battery, clean the battery posts and cables, and store in a clean, dry area.

**NOTE: For storage, use a battery maintainer or make sure the battery is fully charged (see Battery section in this manual).**

8. Store the vehicle indoors in a level position.

### CAUTION

**Avoid storing outside in direct sunlight and avoid using a plastic cover as moisture will collect on the vehicle causing rusting.**

## Preparation after Storage

Taking this vehicle out of storage and correctly preparing it will ensure many hours of trouble-free riding. The manufacturer recommends the following procedure:

1. Clean the vehicle thoroughly.
2. Remove steel wool from the exhaust system.
3. Check all control wires and cables for signs of wear or fraying. Replace if necessary.
4. Change the engine/transmission oil and filter.
5. Check the coolant level and add properly mixed coolant as necessary.
6. Charge the battery; then install. Connect the battery cables making sure to connect the positive cable first.

### CAUTION

**Before installing the battery, make sure the ignition switch is in the OFF position.**

7. Check the entire brake systems (fluid level, pads, etc.), all controls, headlights, taillight, brake light, and headlight aim; adjust or replace if necessary.

8. Check the tire pressure. Inflate to recommended pressure as necessary.

9. Tighten all nuts, bolts, cap screws, and screws making sure all calibrated nuts, cap screws, and bolts are tightened to specifications.

10. Make sure the steering moves freely and does not bind.

11. Check the spark plug. Clean or replace as necessary.

12. Check the air filter and the air filter housing. Clean or replace as necessary.

## **Warranty Procedure/Owner Responsibility**

At the time of sale, an ROV Rider Training Certificate and Owner Registration form must be completed by the selling dealer and consumer. The receipt of the form by Textron Specialized Vehicles (TSV) is a condition precedent to warranty coverage. It is the selling dealer's responsibility to retain and/or submit appropriate copies of the form to the appropriate place(s) to initiate warranty coverage.

The dealer will furnish to the consumer a signed copy of the form which must be presented to a dealer when requesting warranty service. The registration form is the consumer's proof of ownership and warranty eligibility. The form is used by the dealer to validate the warranty claim. You, the owner, should retain your copy of the form and keep it in a safe place.

When the need for warranty repair is suspected, the ROV should be taken to the selling dealer, if possible, who has the primary responsibility to perform warranty repairs. Subject to the limitations set forth in the Limited Warranty, in the event the selling dealer has ceased to do business, you have moved, or you are in a location away from your selling dealer, warranty may be performed by any authorized dealer.

The authorized dealer will examine the ROV or part to determine if, in its opinion, a warrantable condition exists. If a warrantable condition appears to exist, the dealer will repair or replace, at our option, free of charge, including any related labor costs, all parts that are found to be warrantable and any other parts which the warrantable part caused to be damaged. You, the owner, will then be asked to sign a warranty form to ensure TSV that the warranty work was actually performed.

It is the owner's responsibility to maintain and service the vehicle in accordance with the Operator's Manual. To protect yourself and your ROV, follow all safety and service tips. We will NOT warrant non-emissions related repairs required as a result of not performing standard operator maintenance, storage procedures, and service as outlined in the Operator's Manual.

Should you have any questions concerning the warranty, contact an authorized dealer.

# U.S. EPA Emission Control Statement/ Warranty Coverage (U.S. Only)

## STATEMENT/WARRANTY

Textron Specialized Vehicles (TSV) warrants to the original retail purchaser, and each subsequent purchaser, that all U.S. EPA-certified TSV vehicles are designed, built, and equipped to conform to all U.S. EPA Emission Control Regulations. Please read the following information completely.

Your authorized dealer will repair or replace any defective emission-related component at no cost to you during the warranty period. You may have non-warranty service performed by any repair establishment that uses equivalent components. The regulations provide significant civil penalties for tampering that causes your vehicle to no longer meet U.S. EPA emission standards.

TSV further warrants that the engine and its emission-related components are free from defects in materials or workmanship that could cause the engine to fail to comply with applicable regulations during the warranty period.

If you have any questions about this information, or the emission warranty coverage statement, contact your authorized dealer.

## WARRANTY PERIOD

The emission warranty period for this vehicle begins on the same date as the standard warranty coverage and continues for 30 months, 5000 kilometers (3107 miles), or 500 hours, whichever comes first.

## COMPONENTS COVERED

The emissions warranty covers major emissions control components and emission-related components including, but not limited to, the following:

### Engine Management and Sensors

Barometric Pressure Sensor  
Camshaft Position Sensor  
Engine Control Module (ECM)  
Engine Coolant Temperature Sensor  
Manifold Absolute Pressure Sensor  
Oxygen Sensor  
Throttle Position Sensor  
Crankshaft Position Sensor  
Exhaust Temperature Sensor

### Fuel/Air System

Fuel Injectors  
Fuel Pressure Regulator  
Fuel Pump  
Intake Air Temperature Sensor  
Air Bypass Valve  
Crankcase Ventilation System  
ISC Valve

### Ignition System

Ignition Coil  
Knock Sensor System  
Spark Plugs  
Capacitive Discharge Ignition (CDI) Module  
Magneto Pick-Up

### Miscellaneous Items Used in Aforementioned Systems

Connectors  
Switches  
Grommets  
Clamps  
Hoses  
Ties  
Gaskets  
Wiring

## OWNER'S RESPONSIBILITIES

The owner of any ROV warranted under this Emission Control Statement is responsible for the proper maintenance and use of the ROV as stated in the Operator's Manual. Proper maintenance generally includes replacement and service of, at the owner's choosing, such items as air filter, oil and oil filter, or any other part, item, or device related to emissions control as specified in the Operator's Manual. It is the owner's responsibility to ensure that the ROV is used in a manner for which it was designed.

**For U.S. EPA Emission Control Warranty coverage questions, contact Textron Specialized Vehicles at 218-681-9851.**

## **California Emission Control Statement/Warranty Coverage — OHRV (U.S. Only)**

### **STATEMENT/WARRANTY**

The California Air Resources Board is pleased to explain the emission control system warranty on your OHRV. In California, new off-highway recreational vehicles must be designed, built and equipped to meet the State's stringent anti-smog standards. Textron Specialized Vehicles (TSV) must warrant the emission control system on your OHRV for the periods of time listed below provided there has been no abuse, neglect or improper maintenance of your OHRV.

Your emission control system may include parts such as the carburetor or fuel-injection system, fuel tank, fuel hoses, carbon canister, and engine computer. Also included may be hoses, belts, connectors and other emission-related assemblies. Where a warrantable condition exists, TSV will repair your OHRV at no cost to you including diagnosis, parts and labor.

### **WARRANTY PERIOD**

For 30 months, or 2500 miles, or 250 hours, whichever comes first, except for evaporative components over the OHRV high-priced warranty value, which are covered for 60 months, or 5000 miles, or 500 hours, whichever comes first.

If any emission-related part on your OHRV is defective, the part will be repaired or replaced by TSV.

### **OWNER'S RESPONSIBILITIES**

As the OHRV owner, you are responsible for the performance of the required maintenance listed in your owner's manual. TSV recommends that you retain all receipts covering maintenance on your OHRV, but TSV cannot deny warranty solely for the lack of receipts or for your failure to ensure the performance of a scheduled maintenance.

As an owner you are responsible for presenting your OHRV to an authorized dealer as soon as a problem exists. The warranty repairs should be completed in a reasonable amount of time, not to exceed 30 days.

As an OHRV owner, you should also be aware that TSV may deny you warranty coverage if your OHRV or a part has failed due to abuse, neglect, improper maintenance or unapproved modifications.

If you have any questions regarding your warranty rights and responsibilities, you should contact Textron Specialized Vehicles at 218-681-9851 or the California Air Resources Board at 9528 Telstar Avenue, El Monte, CA 91731.

**■ NOTE: An add-on or modified part must be compliant with applicable ARB evaporative emission control standards. A violation of this requirement is punishable by civil and/or criminal punishment.**





# Change of Address, Ownership, or Warranty Transfer

TRACKER OFF ROAD™ keeps on file the current name and address of the owner of this vehicle. This allows us to reach the current owner with any important safety information which may be necessary to protect customers from personal injury or property damage. Please make sure a copy of this form is completed and returned to us if you move or if the vehicle is sold to another party.

This form may also be used to transfer the unused portion of the original warranty to a second party. In order to transfer warranty, fill out this form completely; then return a copy of this form to us. We will then process the application and issue warranty for the balance of the time remaining of the original warranty. Warranty coverage is only available in the country in which the original retail purchase occurs to the original retail purchaser resident in that country or to a transferee resident in that country of the balance of the remaining warranty.

- Address Change
- Ownership Change
- Warranty Transfer

## CHANGE OF ADDRESS/OWNERSHIP/WARRANTY TRANSFER TO:

Name \_\_\_\_\_

Address \_\_\_\_\_

City/State (Province) \_\_\_\_\_

Zip Code (Postal Code) \_\_\_\_\_

Phone (    ) \_\_\_\_\_

Email \_\_\_\_\_

Year and Model \_\_\_\_\_

Vehicle Identification Number (VIN) \_\_\_\_\_

Fold Back

**CHANGE OF ADDRESS/OWNERSHIP**

Place  
Stamp  
Here

TRACKER OFF ROAD  
1451 MARVIN GRIFFIN RD  
AUGUSTA GA 30906-3852  
USA



# Identification Numbers Record

This vehicle has two identification numbers: Vehicle Identification Number (VIN) and Engine Serial Number (ESN). These numbers are required by the dealer to complete warranty claims properly. No warranty will be allowed if the VIN or ESN is removed or mutilated in any way.

Always provide the name, VIN, and ESN when contacting an authorized dealer for parts, service, accessories, or warranty. If a complete engine must be replaced, ask the dealer to notify the manufacturer for correct registration information.

Record the Vehicle Identification Number and Engine Serial Number in the spaces provided to assist you in ordering parts from an authorized dealer or for reference in case this vehicle is stolen.

## 1. KEY IDENTIFICATION NUMBER:

The key identification number is stamped on the key. Record this number in the space provided for reference if you ever need a new key.



MOD254

## 2. VEHICLE IDENTIFICATION NUMBER:

The VIN is located on the operator side of the vehicle, on the frame support rail below the back of the cargo box above the rear shock.

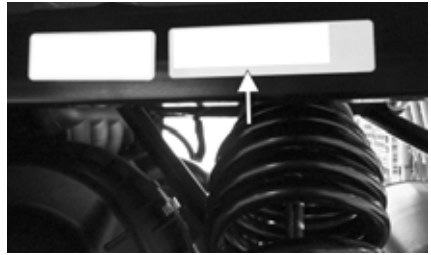

MOD187

## 3. ENGINE SERIAL NUMBER:

The ESN is located above the engine oil filter.

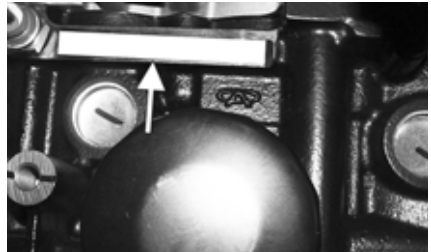

MOD182

## MANUFACTURER INFORMATION:

Textron Specialized Vehicles, Inc.  
1451 Marvin Griffin Road  
Augusta, Georgia 30906-3852 USA

Consumer: 877-394-6727  
[www.trackeroffroad.com](http://www.trackeroffroad.com)

***TRACKER***  
***OFF ROAD™***

©2022 TRACKER OFF ROAD™

®™ Trademarks of White River Marine Group, LLC