

TRACKER
OFF ROAD™

SERVICE MANUAL



p/n: 2263-011
9/20

800SX CREW

Table of Contents

| | | | |
|------------------------------------------------------|-----------|-----------------------------------------------------|------------|
| General Information/Foreword | 2 | Engine | 67 |
| Specifications | 2 | Removing Engine | 67 |
| Torque Specifications | 3 | Cylinder Head and Related Components | 72 |
| Torque Conversions (ft-lb/N-m) | 4 | Removing Cylinder Head and Related Components | 72 |
| Gasoline — Oil — Lubricant | 4 | Servicing Left-Side Components | 91 |
| Preparation for Storage | 5 | Engine Block and Components | 100 |
| Preparation after Storage | 6 | Installing Engine | 102 |
| Periodic Maintenance/Tune-Up | 7 | Troubleshooting | 106 |
| CVT Air Inlet | 7 | Fuel/Lubrication/Cooling | 108 |
| Engine Air Filter | 7 | Throttle Body | 108 |
| Valve Clearance | 10 | Gas Tank | 108 |
| Spark Plug | 11 | Oil Filter/Oil Pump | 109 |
| Muffler/Spark Arrester | 11 | Liquid Cooling System | 110 |
| Engine Oil — Filter | 11 | Troubleshooting | 115 |
| Front Differential Lubricant — Transaxle Fluid | 12 | Electrical System | 116 |
| Driveshaft/Coupling | 13 | Battery | 116 |
| Headlight — Taillight/Brake Light | 13 | Electronic Power Steering (EPS) | 116 |
| Shift Cable | 16 | Ignition Switch | 118 |
| Hydraulic Brake System | 17 | Ignition Coils | 118 |
| Burnishing Brake Pads | 19 | Accessory Receptacle/Connector | 119 |
| Checking/Replacing Drive Belt | 19 | Switches | 119 |
| Steering/Body/Controls | 22 | Fan Motor | 122 |
| Steering Wheel | 22 | Lights | 122 |
| Steering System | 22 | Power Distribution Module (PDM) | 123 |
| Steering Knuckles | 29 | EFI Sensors/Components | 124 |
| Accelerator Pedal | 31 | Winch | 130 |
| Throttle Cable | 31 | Starter Motor | 131 |
| Shift Lever | 31 | Starter Relay | 132 |
| Shift Cable | 33 | Alternator/Regulator | 133 |
| LCD Gauge | 35 | Electronic Control Module (ECM) | 134 |
| Front Wheel Alignment | 35 | Gauge Diagnostic Menu | 134 |
| Hood | 36 | Diagnostic Trouble Codes (DTC) | 137 |
| Front Fenders/Fender Flares | 40 | Wiring Diagram | 141 |
| Side Panels | 42 | Troubleshooting | 142 |
| Doors | 46 | Drive System | 143 |
| Roof (Optional) | 46 | Front Drive Actuator | 143 |
| Dashboard (Mid/Upper) | 52 | Front Differential | 144 |
| Dashboard (Lower) | 53 | Drive Axles | 155 |
| Splash Panel | 55 | Driveshaft | 158 |
| Skid Plates | 56 | Transaxle | 159 |
| Muffler | 56 | Carrier Bearing | 177 |
| Cargo Box | 56 | Hub/Brake Disc | 181 |
| Seats | 58 | Hydraulic Brake Caliper | 183 |
| Behind-the-Seat Storage Box Panel | 61 | Troubleshooting Drive System | 187 |
| Rear Seat Base | 65 | Troubleshooting Brake System | 187 |
| Troubleshooting | 66 | Suspension | 188 |
| | | Shock Absorbers | 188 |
| | | Front A-Arms | 190 |
| | | Rear A-Arms | 193 |
| | | Rear Knuckles | 195 |
| | | Wheels and Tires | 196 |
| | | Troubleshooting | 197 |

General Information/ Foreword



This Service Manual contains service, maintenance, and troubleshooting information for the 2021 800SX Crew model. The complete manual is designed to aid service personnel in service-oriented applications.

This manual is divided into sections. Each section covers a specific vehicle component or system and, in addition to the standard service procedures, includes disassembling, inspecting, and assembling instructions. When using this manual as a guide, the technician should use discretion as to how much disassembly is needed to correct any given condition.

This service manual is designed primarily for use by a basic level service technician. The procedures found in this manual are of varying difficulty, and certain service procedures in this manual require one or more special tools to be completed. The technician should use sound judgment when determining which procedures can be completed based on their skill level and access to appropriate special tools.

NOTE: Whenever a part is worn excessively, cracked, or damaged in any way, replacement is necessary.

When replacement of parts is necessary, use only genuine parts. They are precision-made to ensure high quality and correct fit. Refer to the appropriate Illustrated Parts Manual for the correct part number, quantity, and description.

All publications and decals display the words Warning, Caution, Note, and At This Point to emphasize important information. The symbol  **WARNING** identifies personal safety-related information. Be sure to follow the directive because it deals with the possibility of serious personal injury or even death. A **CAUTION** identifies unsafe practices which may result in vehicle-related damage. Follow the directive because it deals with the possibility of damaging part or parts of the vehicle. The symbol  **NOTE:** identifies supplementary information worthy of particular attention. The symbol  **AT THIS POINT** directs the technician to certain and specific procedures to promote efficiency and to improve clarity.

At the time of publication, all information, photographs, and illustrations were technically correct. Some photographs used in this manual are used for clarity purposes only and are not designed to depict actual conditions. Because products are constantly refined and improved, no retroactive obligation is incurred.

All materials and specifications are subject to change without notice.

Specifications

NOTE: Specifications subject to change without notice.

| MISCELLANEOUS | |
|----------------------------------------------------------|----------------------------------------------------------------------------------|
| Tire Size (Front) | 26 x 10 R14 27 x 9 R14 |
| Tire Size (Rear) | 26 x 10 R14 27 x 11 R14 |
| Front Tire Inflation Pressure (cold) | 83 kPa (12 psi) |
| Rear Tire Inflation Pressure (cold) | 96.5 kPa (14 psi) |
| Fuel Tank Capacity | 37.85 L (10 U.S. gal.) |
| Coolant Capacity | 6.54 L (6.92 U.S. qt) |
| Front Differential Capacity | 198 ml (6.7 fl oz) |
| Transaxle Capacity | 1.21 L (41 fl oz) |
| Engine Oil Capacity (approx) | 2.37 L (2.5 U.S. qt) |
| Gas (recommended) | Regular unleaded 87 octane (R+M)/2, ethanol content not to exceed 10% |
| Engine Oil (recommended) | 0W-40 Synthetic |
| Front Differential Lubricant | SAE-Approved 80W-90 Hypoid |
| Transaxle Lubricant | Transaxle Fluid with EP |
| Drive Belt Width (min) | 30 mm (1.2 in.) |
| Brake Fluid | DOT 4 |
| Taillight/Brake Light | 12.8V-27W/14V-8W |
| Headlight | 12V/60/55W |
| Engine Idle RPM | 950 ± 50 |
| Engine Max RPM | 6300 |
| ELECTRICAL SYSTEM | |
| Alternator Output | 75 amps (max) |
| VALVES AND GUIDES | |
| Valve/Tappet Clearance(intake) (cold engine)(exhaust) | 0.13-0.23 mm 0.20-0.30 mm |
| Valve Guide/Stem Clearance(intake) (exhaust) | 0.07 mm (limit) 0.08 mm (limit) |
| Valve Guide Inside Diameter | 5.0 mm (standard) |
| Valve Spring Free Length | 37 mm (benchmark) |
| Valve Spring Distortion | 1.2 mm (limit) |
| CYLINDER, PISTON, AND RINGS | |
| Cylinder Bore Out-Of-Round | 0.03 mm (limit) |
| Piston to Cylinder Clearance | 0.10 mm (limit) |
| Piston Ring Groove Clearance | 0.12 mm (limit primary) 0.11 mm (limit secondary) |
| Piston Ring End Gap | 0.65 mm (limit primary) 0.65 mm (limit secondary) 1.00 mm (limit oil ring) |
| CRANKSHAFT | |
| Crankshaft Main Bearing Journal | 0.10 mm (limit) |
| Crankshaft Connecting Rod Journal (min) | 0.07 mm (limit) |
| CAMSHAFT AND CYLINDER HEAD | |
| Cam Lobe Height (intake/exhaust) (min) | 22.9 mm |
| Cylinder Head Distortion (max) | 0.10 mm |

Torque Specifications

■NOTE: Torque specifications have the following tolerances:

| Torque (ft-lb) | Tolerance |
|----------------|-----------|
| 0-15 | ±20% |
| 16-39 | ±15% |
| 40+ | ±10% |

| Part | Part Bolted to | Torque ft-lb | N-m |
|---------------------------------|------------------------------------|-----------------|------|
| EXHAUST COMPONENTS | | | |
| Exhaust Pipe Flange | Cylinder Head | 45 | 61.2 |
| Exhaust Pipe | Muffler | 16 | 21.8 |
| Oxygen Sensor | Exhaust Pipe | 20 | 27.2 |
| INTAKE COMPONENTS | | | |
| Air Cleaner Mount | Frame | 16 | 21.8 |
| Intake Hose 2" Elbow | Manifold & Intake Duct | 11 in-lb | 1.25 |
| Intake Hose 2" Elbow | Intake Duct & Air Cleaner Assembly | 11 in-lb | 1.25 |
| Intake Hose Inlet | Air Cleaner Assembly | 11 in-lb | 1.25 |
| Clamp | Frame | 17 in-lb | 1.92 |
| COOLING COMPONENTS | | | |
| Radiator Bracket | Frame Stamping | 20 | 27.2 |
| FUEL SYSTEM COMPONENTS | | | |
| Fuel Pump | Fuel Tank | 70 | 95.2 |
| BRAKE COMPONENTS | | | |
| Master Cylinder | Frame | 16 | 21.8 |
| Master Cylinder Remove Tank | Frame | 4 | 5.4 |
| Rear Brake Hose | Master Cylinder | 20 | 27.2 |
| Rear Brake Hoses | Hydraulic Caliper | 20 | 27.2 |
| Front Brake Hose | Master Cylinder | 20 | 27.2 |
| Front Brake Hoses | Hydraulic Caliper | 20 | 27.2 |
| Rear Brake Hose | Frame | 6 | 8.2 |
| Front Brake Hose | Frame | 6 | 8.2 |
| Brake Pedal | Frame | 16 | 21.7 |
| Knuckle | Front Brake Caliper | 45 | 61.2 |
| Knuckle | Rear Brake Caliper | 45 | 61.2 |
| ACCELERATOR COMPONENTS | | | |
| Accelerator Pedal | Splash Panel | 8 | 10.9 |
| SHIFTER COMPONENTS | | | |
| Tilt Steering Sub-Assembly | Frame | 16 | 21.8 |
| Steering Column Support Bracket | Steering Column | 24 in-lb | 2.72 |
| Shifter Cable Eyelet | Shifter Column Casting | 6 | 8.2 |
| Shift Cable Threads | Tilt Steering Sub-Assembly | 20 | 27.2 |
| Shift Cable Threads | Shift Cable Bracket Transaxle | 20 | 27.2 |
| Shift Lever | Shifter Knob | 20 | 27.2 |
| Shift Cable Bracket | Transaxle | 8 | 10.9 |
| ELECTRICAL COMPONENTS | | | |
| Tilt Sensor | Frame | 5 | 6.8 |
| Starter Solenoid | Frame | 10 | 13.6 |
| Ground Wire | Engine | 16 | 21.8 |
| ECM | Behind-the-Seat Storage Box | 12 in-lb | 1.36 |
| Starter | Engine Backplate | 14.8 | 20 |
| Alternator Pivot | Engine Block | 33.2 | 45 |
| Alternator Adjuster | Alternator Bracket | 14.8 | 20 |
| PDM Bracket | Frame | 10 | 13.6 |
| STEERING COMPONENTS | | | |

| | | | |
|------------------------------------------------|---------------------------------|----------|------|
| Rack & Pinion Housing | Bracket, Rack Mount | 16 | 21.8 |
| Bracket Rack Mount | Frame (with weld nut) | 45 | 61.2 |
| Bracket Rack Mount | Frame (with nut) | 16 | 21.8 |
| Intermediate Shaft | Rack & Pinion | 45 | 61.2 |
| Steering Shaft | Steering Wheel | 25 | 34 |
| Tilt Steering Subassembly | Frame | 16 | 21.8 |
| Bracket Steering Column Support | Steering Column | 24 in-lb | 2.72 |
| Tilt Steering Shock | Bracket Steering Column Support | 6 | 8.2 |
| Tilt Steering Shock | Frame | 6 | 8.2 |
| EPS Mount Brackets | Frame | 16 | 21.8 |
| EPS Mount Brackets | EPS Unit | 16 | 21.8 |
| Intermediate Shaft | EPS Unit | 24 | 32.6 |
| CHASSIS ASSEMBLY | | | |
| Skid Plates | Frame | 6 | 8.2 |
| Bumper | Frame | 16 | 21.8 |
| Front Engine Bracket — Driver Side | Frame | 45 | 61.2 |
| Front Engine Bracket — Passenger Side | Frame | 45 | 61.2 |
| Front Engine Bracket — Driver & Passenger Side | Front Engine Mount Assembly | 16 | 21.8 |
| Seat Structure | Frame | 6 | 8.2 |
| Bumper Bracket | Frame | 20 | 27.2 |
| Rubber Mount | Engine Bracket | 45 | 61.2 |
| Tow Hook | Frame | 20 | 27.2 |
| Cargo Box Hinge Point | Frame | 30 | 40.8 |
| Cargo Box Shock | Frame/Cargo Box | 10 | 13.6 |
| SEAT ASSEMBLY | | | |
| Driver Seat Tube | Driver Seat Base/Backrest | 2 | 2.7 |
| Seat Slider | Seat Tube | 8 | 10.9 |
| Seat Slider | Seat Structure | 2 | 2.7 |
| Seat Bracket | Seat Tube | 8 | 10.9 |
| Lock Handle | Seat Bracket | 8 | 10.9 |
| Seat Belt Retractor/Anchor | Frame | 60 | 81.6 |
| Seat Belt D-loop | Rear ROPS | 35 | 47.6 |
| ROPS ASSEMBLY | | | |
| Canopy Front Hoop | Frame | 45 | 61.2 |
| Canopy Front Hoop | Canopy Center Hoop | 45 | 61.2 |
| Canopy Rear Hoop | Frame | 45 | 61.2 |
| Canopy Center Hoop | Canopy Rear Hoop | 45 | 61.2 |
| Canopy Center Hoop | Frame | 16 | 21.8 |
| Shoulder Restraint Upper | Frame | 20 | 27.2 |
| Shoulder Restraint Lower | Frame | 20 | 27.2 |
| Flag Mount Bracket | Canopy Rear Hoop | 6 | 8.2 |
| SUSPENSION COMPONENTS (Front) | | | |
| Front Shock | Frame/Upper A-Arm | 45 | 61.2 |
| Upper A-Arms | Frame | 45 | 61.2 |
| Lower A-Arms | Frame | 45 | 61.2 |
| Ball Joint | Knuckle | 45 | 61.2 |
| Knuckle** | Tie Rod End | 32 | 43.5 |
| Knuckle Assembly/Front Hub | Front Axle | 250 | 339 |
| Sway Bar Mount | Frame | 20 | 27.2 |
| Sway Bar Link | Sway Bar (1-2 threads exposed) | | |
| Sway Bar Link | A-arm (5-6 threads exposed) | | |
| SUSPENSION COMPONENTS (Rear) | | | |
| Upper A-Arms | Frame | 45 | 61.2 |
| Lower A-Arms | Frame | 45 | 61.2 |
| Lower A-Arm | Knuckle Assembly | 45 | 61.2 |
| Upper A-Arm | Knuckle Assembly | 45 | 61.2 |
| Rear Shock | Upper A-Arm | 45 | 61.2 |
| Rear Shock | Frame | 45 | 61.2 |
| Knuckle Assembly/Rear Hub | Rear Axle | 250 | 339 |

| Part | Part Bolted to | Torque | |
|-------------------------------|-----------------------------|-----------|------|
| | | ft-lb | N-m |
| DRIVE TRAIN COMPONENTS | | | |
| Top Differential Mount | Frame | 16 | 21.8 |
| Frame | Lower Differential Mount | 16 | 21.8 |
| Differential | Top Differential Mount | 45 | 61.2 |
| Differential | Bottom Differential Mount | 45 | 61.2 |
| Drain Plug | Front Differential | 45 in-lb | 5.09 |
| Oil Inspection Plug | Front Differential | 45 in-lb | 5.09 |
| Fill Plug | Front Differential | 16 | 21.8 |
| Rear Transaxle Mount Bracket | Transaxle | 45 | 61.2 |
| Engine Backplate/Transaxle* | Engine/Transaxle Bracket | 75 | 102 |
| Transaxle Mount Bracket* | Engine | 55 | 74.8 |
| Rear Transaxle Mount Bracket | Rear Rubber Mounts | 45 | 61.2 |
| Rear Rubber Mounts | Frame | 45 | 61.2 |
| Driven Clutch | Transaxle | 60 | 81.6 |
| Drive Clutch | Engine | 60 | 81.6 |
| Speed Sensor | Transaxle | 10 | 13.6 |
| Drain Plug | Transaxle | 16 | 21.8 |
| Fill Plug | Transaxle | 16 | 21.8 |
| Wheel | Hub (20 ft-lb increments) | 100 | 136 |
| CVT Inlet/Exhaust Tubes | Hose Clamp | 15 in-lb | 1.70 |
| CVT Exhaust Tube | CVT Exhaust Support Bracket | 17 in-lb | 1.92 |
| Inner Clutch Cover | Transaxle | 8 | 10.9 |
| Driven Cam | Driven Clutch | 47 in-lb | 5.3 |
| Drive Clutch Cover | Drive Clutch | 110 in-lb | 12.4 |
| Drive Clutch Cam Arms | Drive Clutch | 50 in-lb | 5.6 |
| Flywheel | Engine Crankshaft | 51.7 | 70 |
| PTO Stub Shaft | Flywheel | 36.9 | 50 |
| ENGINE ASSEMBLY | | | |
| Drain Plug | Oil Pan | 36.9 | 50 |
| Front Engine Mount | Engine | 55 | 74.8 |
| Front Engine Mount | Backplate | 20 | 27.2 |
| Crankshaft Sensor Bracket | Backplate | 8 | 10.9 |
| Crankshaft Sensor | Crankshaft Sensor Bracket | 8 | 10.9 |
| Connecting Rod Cap | Connecting Rod (4 Steps) | 29.5 | 40 |
| Main Bearing Cap | Engine Block (6 Steps) | 51.7 | 70 |
| Camshaft Caps | Cylinder Head | 6.7 | 9 |
| Cylinder Head | Cylinder (5 steps) | 51.7 | 70 |
| Oil Pump | Engine Block | 14.8 | 20 |
| Serpentine/Timing Belt Pulley | Crankshaft | 73.8 | 100 |
| Camshaft Timing Belt Pulley | Camshaft | 73.8 | 100 |
| Timing Belt Idler Nut | Engine Block | 18.5 | 25 |
| Timing Belt Cover | Engine | 4.5 | 6 |
| Oil Pan | Crankcase | 7.4 | 10 |
| Crankshaft Seal/Flange | Engine Block | 14.8 | 20 |
| Thermostat Housing | Cylinder Head | 14.8 | 20 |
| Water Pump | Engine Block | 14.8 | 20 |

* w/Blue Loctite #243 ** w/Red Loctite #271

Torque Conversions (ft-lb/N-m)

| ft-lb | N-m | ft-lb | N-m | ft-lb | N-m | ft-lb | N-m |
|-------|------|-------|------|-------|-------|-------|-------|
| 1 | 1.4 | 26 | 35.4 | 51 | 69.4 | 76 | 103.4 |
| 2 | 2.7 | 27 | 36.7 | 52 | 70.7 | 77 | 104.7 |
| 3 | 4.1 | 28 | 38.1 | 53 | 72.1 | 78 | 106.1 |
| 4 | 5.4 | 29 | 39.4 | 54 | 73.4 | 79 | 107.4 |
| 5 | 6.8 | 30 | 40.8 | 55 | 74.8 | 80 | 108.8 |
| 6 | 8.2 | 31 | 42.2 | 56 | 76.2 | 81 | 110.2 |
| 7 | 9.5 | 32 | 43.5 | 57 | 77.5 | 82 | 111.5 |
| 8 | 10.9 | 33 | 44.9 | 58 | 78.9 | 83 | 112.9 |
| 9 | 12.2 | 34 | 46.2 | 59 | 80.2 | 84 | 114.2 |
| 10 | 13.6 | 35 | 47.6 | 60 | 81.6 | 85 | 115.6 |
| 11 | 15 | 36 | 49 | 61 | 83 | 86 | 117 |
| 12 | 16.3 | 37 | 50.3 | 62 | 84.3 | 87 | 118.3 |
| 13 | 17.7 | 38 | 51.7 | 63 | 85.7 | 88 | 119.7 |
| 14 | 19 | 39 | 53 | 64 | 87 | 89 | 121 |
| 15 | 20.4 | 40 | 54.4 | 65 | 88.4 | 90 | 122.4 |
| 16 | 21.8 | 41 | 55.8 | 66 | 89.8 | 91 | 123.8 |
| 17 | 23.1 | 42 | 57.1 | 67 | 91.1 | 92 | 125.1 |
| 18 | 24.5 | 43 | 58.5 | 68 | 92.5 | 93 | 126.5 |
| 19 | 25.8 | 44 | 59.8 | 69 | 93.8 | 94 | 127.8 |
| 20 | 27.2 | 45 | 61.2 | 70 | 95.2 | 95 | 129.2 |
| 21 | 28.6 | 46 | 62.6 | 71 | 96.6 | 96 | 130.6 |
| 22 | 29.9 | 47 | 63.9 | 72 | 97.9 | 97 | 131.9 |
| 23 | 31.3 | 48 | 65.3 | 73 | 99.3 | 98 | 133.3 |
| 24 | 32.6 | 49 | 66.6 | 74 | 100.6 | 99 | 134.6 |
| 25 | 34 | 50 | 68 | 75 | 102 | 100 | 136 |

Gasoline – Oil – Lubricant

FILLING GAS TANK

WARNING

Always fill the gas tank in a well-ventilated area. Never add gas to the tank near any open flames or with the engine running. DO NOT SMOKE while filling the tank.

Since gasoline expands as its temperature rises, the tank must be filled to its specified capacity only. Expansion room must be maintained in the tank particularly if the tank is filled with cold gas and then moved to a warm area.

WARNING

Do not overflow gasoline when filling the tank. A fire hazard could materialize. Always allow the engine to cool before filling the gas tank.

Tighten the gas tank cap securely after filling the tank.

WARNING

Do not over-fill the gas tank.

RECOMMENDED GASOLINE

The recommended gasoline to use is 87 minimum octane regular unleaded. In many areas, oxygenates are added to the gasoline. Oxygenated gasolines containing up to 10% ethanol or 5% methanol are acceptable gasolines.

When using ethanol-blended gasoline, it is not necessary to add a gasoline antifreeze since ethanol will prevent the accumulation of moisture in the fuel system.

CAUTION

Do not use white gas. Only approved gasoline additives should be used.

RECOMMENDED ENGINE OIL

CAUTION

Any oil used in place of the recommended oil could cause serious engine damage. Do not use oils which contain graphite or molybdenum additives. Also, not recommended are racing, vegetable, non-detergent, and castor-based oils.

The recommended oil to use is ACX All Weather synthetic engine oil, which has been specifically formulated for use in this engine. Although All Weather synthetic engine oil is the only oil recommended for use in this engine, use of any API-certified 0W-40 oil is acceptable.

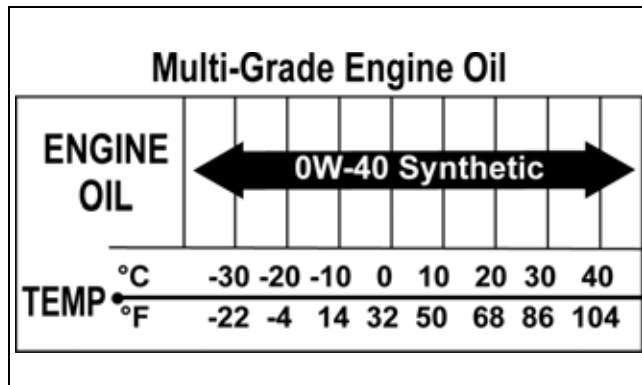

RECOMMENDED FRONT DIFFERENTIAL LUBRICANT

The recommended lubricant is SAE-approved 80W-90 hypoid. This lubricant meets all of the lubrication requirements of the vehicle's front differential.

CAUTION

Any lubricant used in place of the recommended lubricant could cause serious front differential/rear drive damage.

RECOMMENDED TRANSAXLE LUBRICANT

The recommended lubricant is transaxle fluid with EP. This lubricant meets all of the lubrication requirements of this vehicle's transaxle.

Preparation for Storage

The manufacturer recommends the following procedure to prepare the vehicle for storage. An authorized dealer should perform this service; however, the owner/operator may perform this service if desired.

CAUTION

Prior to storing this vehicle, it must be properly serviced to prevent rusting and component deterioration.

1. Clean the vehicle thoroughly by washing dirt, oil, grass, and other foreign matter from the entire vehicle. Allow the vehicle to dry thoroughly. DO NOT get water into any part of the engine or air intake.
2. Either drain the gas tank or add a fuel stabilizer to the gas in the gas tank.
3. Clean the interior of the air filter housing.
4. Plug the hole in the exhaust system with steel wool.
5. Apply light oil to the upper steering shaft bushing and plungers of the shock absorbers.
6. Tighten all nuts, bolts, cap screws, and screws. Make sure rivets holding components together are tight. Replace all loose rivets. Care must be taken that all calibrated nuts, cap screws, and bolts are tightened to specifications.
7. Fill the cooling system to the recommended level with properly mixed coolant.
8. Disconnect the battery cables (negative cable first); then remove the battery, clean the battery posts and cables, and store in a clean, dry area.

■NOTE: For storage, use a battery maintainer or make sure the battery is fully charged (see Battery section in this manual).

9. Store the vehicle indoors in a level position.

CAUTION

Avoid storing outside in direct sunlight and avoid using a plastic cover as moisture will collect on the vehicle causing rusting.

Preparation after Storage

Taking this vehicle out of storage and correctly preparing it will ensure many miles and hours of trouble-free riding. The manufacturer recommends the following procedure:

1. Clean the vehicle thoroughly.
2. Remove the steel wool from the exhaust system. Clean the spark arrestor.
3. Check all control wires and cables for signs of wear or fraying. Replace if necessary.
4. Change the engine oil and filter. Change the transaxle fluid. Change the front differential fluid.
5. Check the coolant level and add properly mixed coolant as necessary.

6. Charge the battery; then install. Connect the battery cables making sure to connect the positive cable first.

CAUTION

Before installing the battery, make sure the ignition switch is in the OFF position.

7. Check the entire brake systems (fluid level, pads, etc.), all controls, headlights, taillight, brake light, and headlight aim; adjust or replace if necessary.
8. Check the tire pressure. Inflate to recommended pressure as necessary.
9. Tighten all nuts, bolts, cap screws, and screws making sure all calibrated nuts, cap screws, and bolts are tightened to specifications.
10. Make sure the steering moves freely and does not bind.
11. Check the air filter and the air filter housing. Clean or replace as necessary.
12. Check the spark plugs. Clean or replace as necessary.

Periodic Maintenance/ Tune-Up

Tighten all nuts, bolts, and cap screws. Care must be taken that all calibrated nuts, bolts, and cap screws are tightened to specifications.

It is advisable to lubricate certain components periodically to ensure free movement. Apply light oil to the components using the following list as reference:

- A. Accelerator Pedal Pivot
- B. Brake Pedal Pivot
- C. Shift Cable

SPECIAL TOOLS

A number of special tools must be available to the technician when performing service procedures in this section. Refer to the current Special Tools Catalog for the appropriate tool description.

■NOTE: When indicated for use, each special tool will be identified by its specific name, as shown in the chart below, and capitalized.

| Description | p/n |
|-------------------------------------|----------|
| Drive and Driven Clutch Holder Tool | 0444-317 |
| Hub Retaining Wrench | 0444-270 |

■NOTE: Special tools are available from the Service Department.

CVT Air Inlet

This vehicle is equipped with an air inlet to collect air for the Continuously Variable Transmission (CVT).

■NOTE: When servicing clutches or belt, it is recommended to inspect and clean the CVT air inlet.

1. Remove the left-side access panel; loosen the clamp that holds the snorkel portion to the air inlet.



MOD205

2. Disconnect snorkel portion from air inlet; clean and inspect.

3. Install the snorkel to the air inlet and tighten the clamp securely. Reinstall the left-side access panel.

Engine Air Filter

Primary Air Filter/Safety Filter/Clean-out Valve

The engine air filter inside the air filter housing must be kept clean to provide good engine power and fuel mileage. If the vehicle is used under normal conditions, service the filter at the intervals specified. If operated in dusty, wet, or muddy conditions, inspect and service the filter more frequently. Use the following procedure to clear the clean-out valve, remove the primary filter and safety filter, and inspect and/or clean them.

CAUTION

Failure to inspect the air filter frequently if the vehicle is used in dusty, wet, or muddy conditions can damage the engine.

■NOTE: To access the air filter housing, the right-side access panel must be removed and the cargo box raised if desired.

REMOVING AND INSPECTING

1. Remove dirt and debris from around the air filter housing cover; then squeeze the clean-out valve to clear it of any accumulated dirt or dust.
2. Check the clean-out valve for cracks or damage. Replace as needed.



MOD085

3. Pull out on the orange air filter housing cover lock; then turn the air filter housing cover counterclockwise to access the filter.

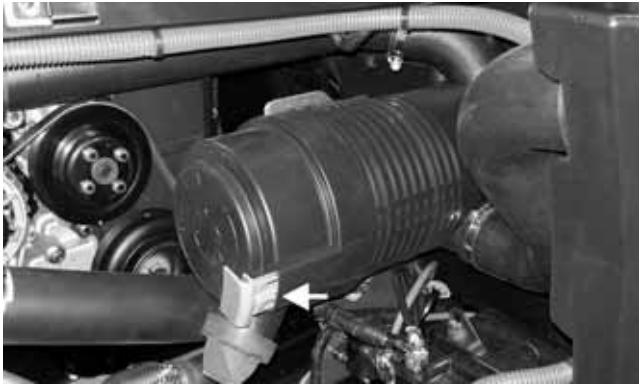

MOD084A

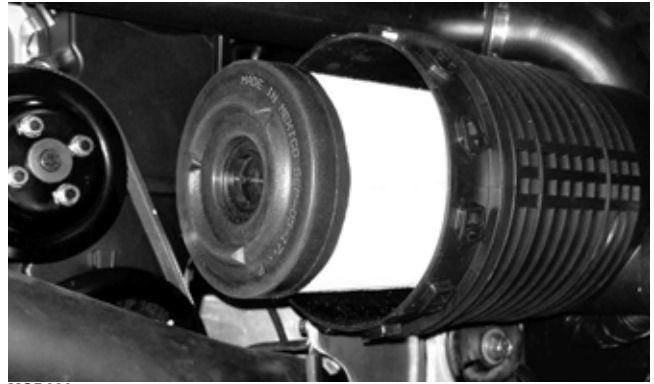

MOD086



MOD084B

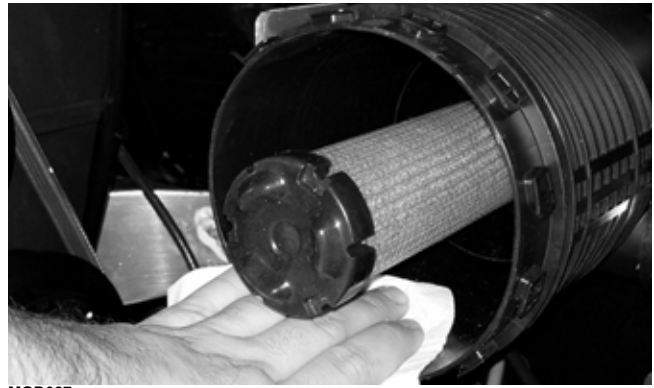

MOD087

4. Loosen the clamp indicated and disconnect the snorkel from the housing; then clean and inspect the inside of the snorkel; then remove the primary air filter element; then wipe the inside of the housing to remove dirt and debris.

5. Inspect the primary air filter element for damage or dirt. If damaged the filter must be replaced.
6. A dust trail anywhere inside of the air filter housing, inlet tube or on the safety filter is a telltale sign of a leak. Leaks should be inspected by an authorized dealer.

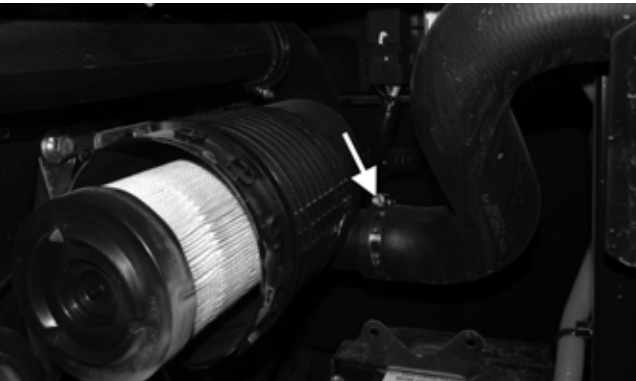

MOD597

CAUTION

Do not attempt to clean the primary filter or filter damage may occur.

CAUTION

When replacing the primary filter, always inspect the new filter for damage. Never install a damaged filter. Do not wipe the new filter as it is lubricated for sealing purposes.

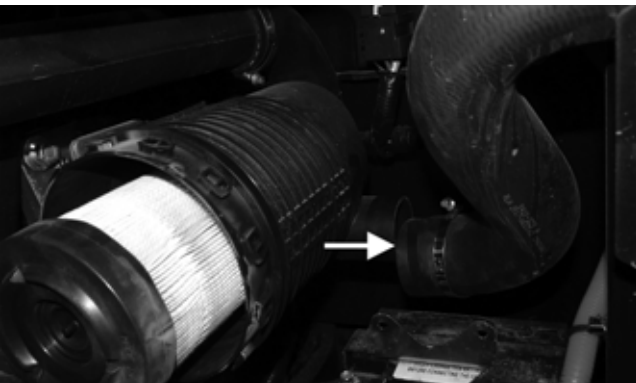

MOD598



MOD088



MOD089

7. Remove and inspect the safety filter.

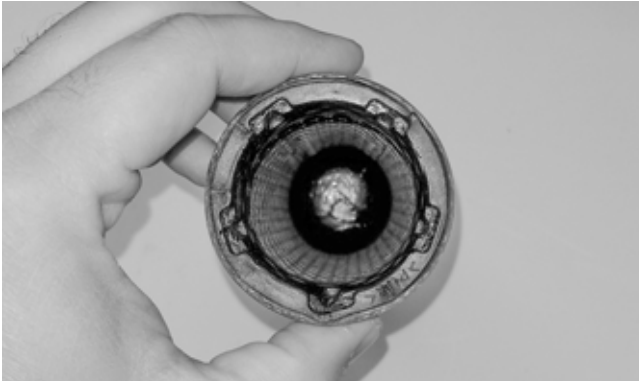

MOD090

INSTALLING

1. Install safety filter; then install the primary filter.

■NOTE: The flower shape of the primary filter element must line up with the same-shaped void in the air filter housing for the air filter housing cover to fit properly.

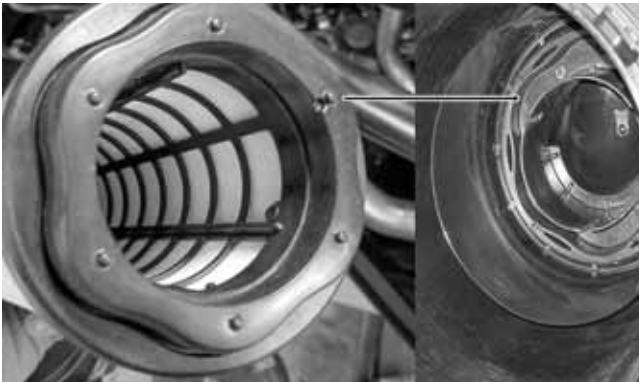

MOD091A

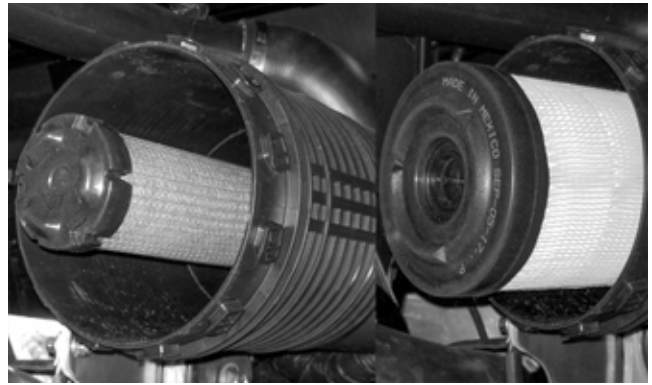

MOD092

2. Install the air filter housing cover with the clean-out valve at the 5 o'clock position; then turn the air filter housing cover clockwise until it seats.

■NOTE: The clean-out valve should be near the 6 o'clock position when the cover is seated.

3. Lock the air filter housing cover.

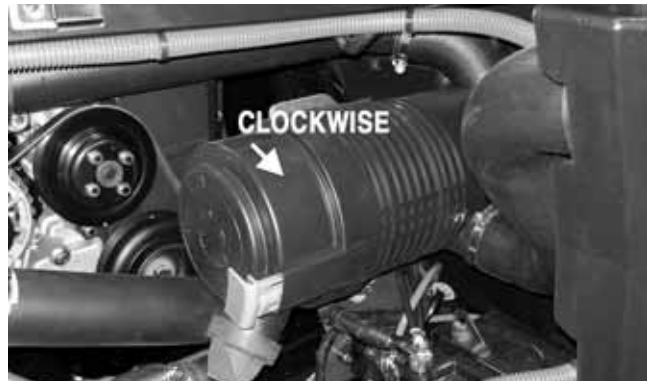

MOD084C

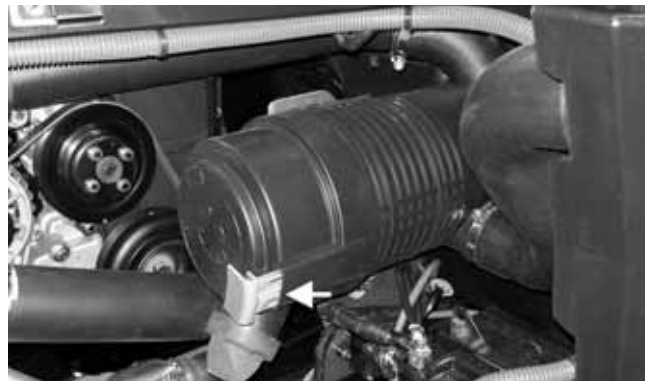

MOD084A

4. Connect the snorkel to the housing; then tighten the clamp securely.



MOD597

5. Install the right access panel and secure with two 1/4-turn fasteners.

CAUTION

A torn air filter can cause damage to the engine. Dirt and dust may get inside the engine if the element is torn. Carefully examine the element for tears before and after cleaning it. Replace the element with a new one if it is torn.

Valve Clearance

Checking Valve Clearance

■ **NOTE:** The engine does not need to be removed from the vehicle for this procedure.

1. Disconnect the negative battery cable; then remove the valve cover (see REMOVE AND INSTALL VALVE COVER).

■ **NOTE:** There are two intake and two exhaust valves per cylinder. The intake camshaft and valves are next to the intake manifold and the exhaust camshaft and valves are next to the exhaust manifold.

2. Remove the spark plugs, making sure no dirt or foreign material enters the cylinders.

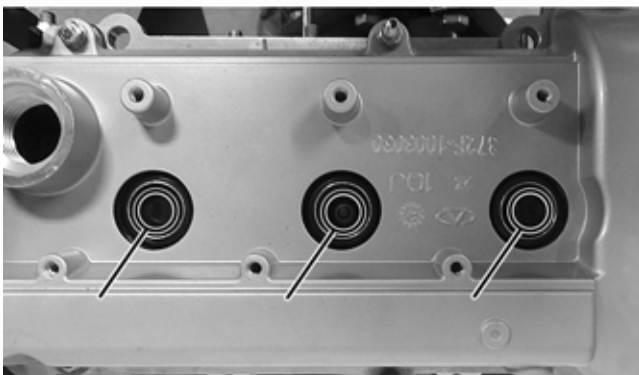

MF034B

3. Using a suitable bar, turn the crankshaft in the direction of rotation until the highest section of the camshaft lobes (A) of the valves to be checked are pointing directly away from the valve bucket (B).



MF039A

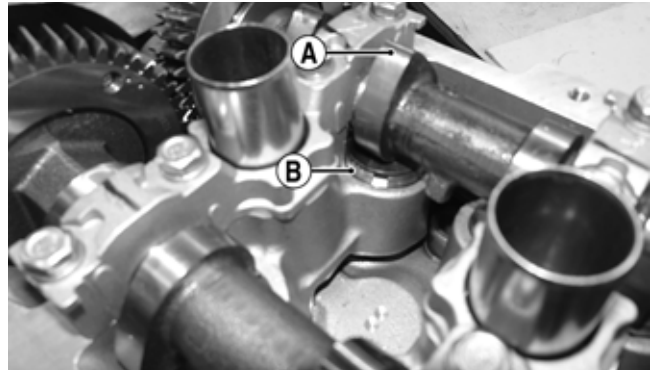

MF078A

4. Using a suitable feeler gauge, check clearance between the camshaft and the valve bucket recording the value when a slight drag is felt when inserting and retracting the gauge blade.

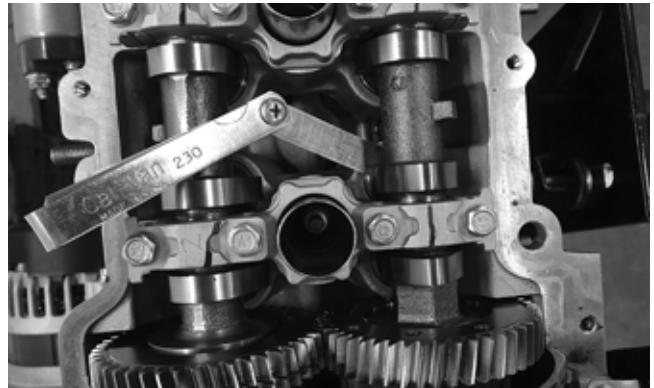

MF037

5. Repeat and record clearance values for all remaining valves

■ **NOTE:** Intake valve clearance specification is 0.18 ± 0.05 mm (0.007 ± 0.002 in.). Exhaust valve clearance specification is 0.25 ± 0.05 mm (0.010 ± 0.002 in.).

6. Install the valve cover (see REMOVE AND INSTALL VALVE COVER); then connect the battery cables.

Spark Plug

A light brown insulator indicates that the plug and fuel/air ratio are correct. A white or dark insulator indicates that the engine may need to be serviced. To maintain a hot, strong spark, keep the plug free of carbon.

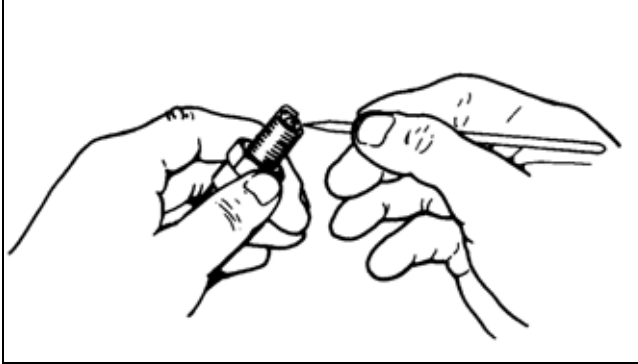

ATV-0051

CAUTION

Before removing the spark plug, be sure to clean the area around the spark plug. Dirt could enter engine when removing or installing the spark plug.

Adjust the gap to 1.0 mm (± 0.1 mm).

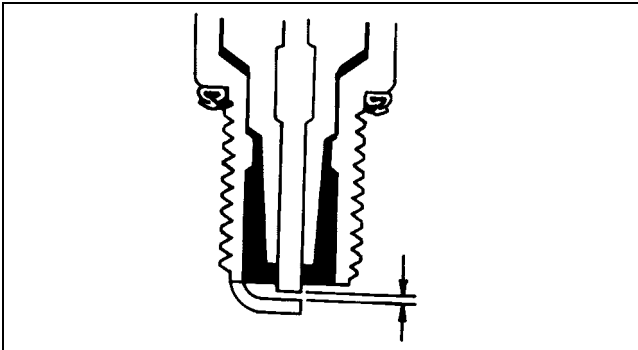

ATV0052

Tighten spark plug to 14.75 ft-lb (20 N-m).

Muffler/Spark Arrester

The muffler has a spark arrester which must be periodically cleaned. At the intervals shown in the Maintenance Schedule, clean the spark arrester using the following procedure.

⚠ WARNING

Wait until the muffler cools to avoid burns.

1. Remove the cap screw securing the spark arrester assembly to the muffler.



MOD095A

2. Using a suitable brush, clean the carbon deposits from the screen taking care not to damage the screen.

■NOTE: If the screen is damaged in any way, it must be replaced.

3. Install the spark arrester assembly and secure with the cap screw. Tighten to 60 in.-lb (6.8 N-m).

Engine Oil – Filter

Change the engine oil and oil filter at the scheduled intervals. The engine should always be warm when the oil is changed so the oil will drain easily and completely.

1. Park the vehicle on level ground.
2. Remove the maintenance cover to access the oil filter.

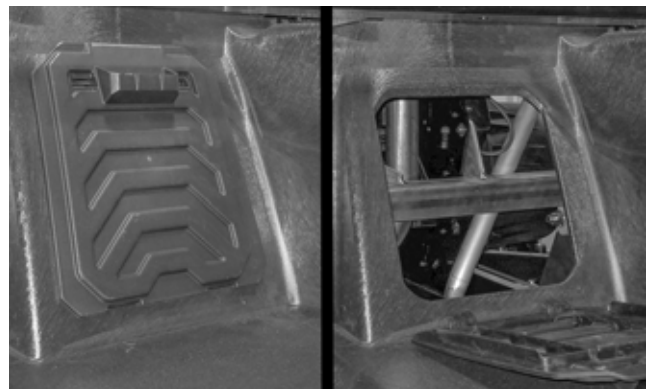

MOD105

3. Tilt the cargo box to the dump position; then loosen the oil fill cap. Be careful not to allow contaminants to enter the opening.

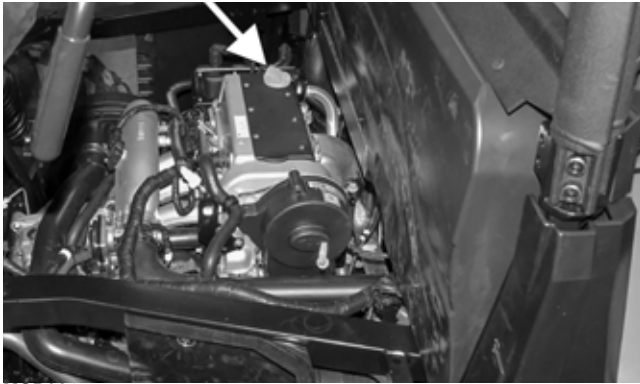

MOD064

4. Remove the drain plug from the bottom of the engine and drain the oil into a drain pan.

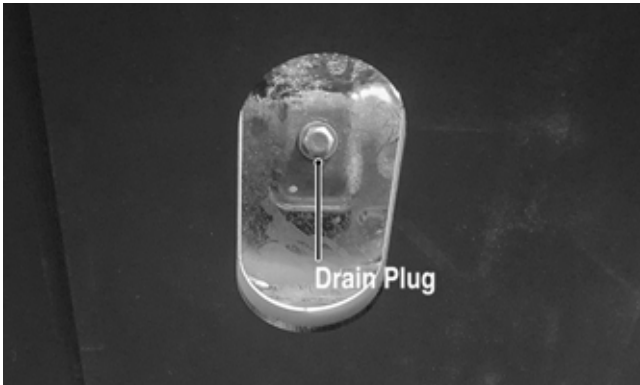

MOD020A

5. Using the oil filter wrench and a ratchet handle (or a socket or box-end wrench), remove the old oil filter and dispose of properly. Capture oil in a suitable pan or absorbent material. Do not re-use oil filter.

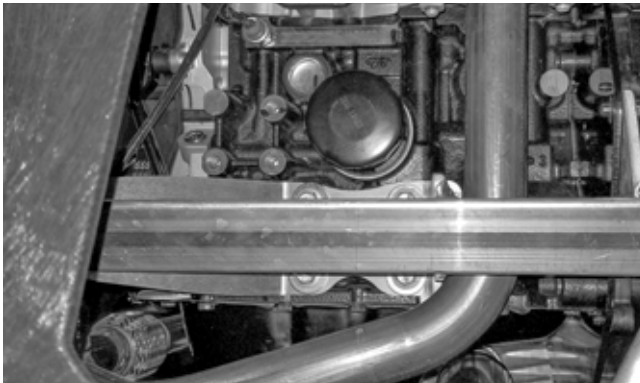

MOD106

■**NOTE:** Clean up any excess oil after removing the filter.

6. Apply oil to the new filter O-ring and check to make sure it is positioned correctly; then install the new oil filter. Tighten securely.
7. Install the engine drain plug and tighten to 36.9 ft-lb (50 N-m). Pour the recommended oil into the filler hole. Install oil fill cap.
8. Start the engine (while the vehicle is outside on level ground) and allow it to idle for a few minutes.
9. Turn the engine off and wait approximately one minute. Recheck the oil level.

10. Inspect the area around the drain plug and oil filter for leaks.
11. Install the maintenance cover.
12. Check to make sure the oil fill cap is secure and the oil level stick is installed correctly; then lower the cargo box to its locked down position.

Front Differential Lubricant — Transaxle Fluid

INSPECTING/CHANGING

Inspect and change the lubricant/fluid in each according to the Maintenance Schedule. Use the appropriate lubricant and the following procedure:

1. Place the vehicle on level ground; then remove the fill plugs on the front differential (A) and transaxle (C).

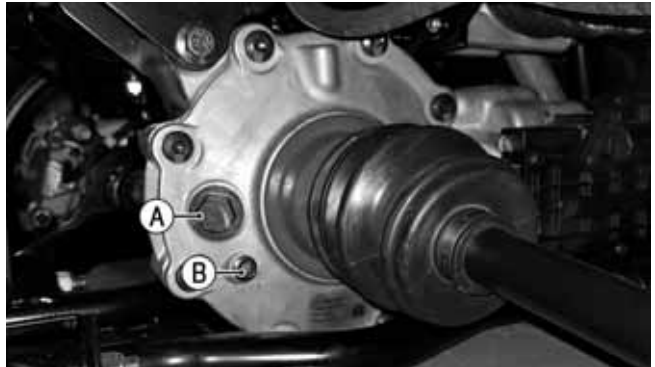

MOD073A



MOD085A

2. Drain the lubricant/fluid into a drain pan by removing the drain plugs from the right-side front differential (E) and transaxle (D).

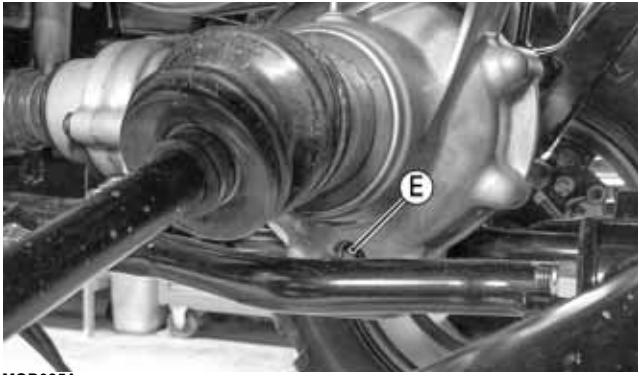

MOD085A



MOD085A

3. After the lubricant/fluid has been drained, install the drain plugs and tighten to 45 in.-lb (5.1 N-m) (front differential) and 16 ft-lb (21.8 N-m) (transaxle).

CAUTION

Inspect the lubricant/fluid for any signs of metal filings or water. If found, take the vehicle to an authorized dealer for servicing.

4. Pour recommended quantity and type of lubricant/fluid into each fill hole, as follows:

Front differential fill plug (A) — add lubricant until it is level with the lubricant inspection plug (B).

Transaxle fill and fluid inspection plug (C) — add fluid until it is level with the bottom of (C).

5. Install the fill plugs and tighten to 16 ft-lb (21.8 N-m) and install the front differential lubricant inspection plug to 45 in.-lb (5.1 N-m).

■NOTE: If the lubricant/fluid is contaminated with water, inspect the drain plug, fill plug, and/or seals.

Driveshaft/Coupling

The following drive system components should be inspected periodically to ensure proper operation.

- A. Spline lateral movement (slop).
- B. Coupling cracked, damaged, or worn.

Headlight — Taillight/Brake Light

Light Bulb Replacement

CAUTION

Use only specified bulbs indicated in the Specifications chart as replacement bulbs.

■NOTE: The bulb portion of the headlight is fragile. HANDLE WITH CARE. When replacing the headlight bulb, do not touch the glass portion of the bulb. If the glass is touched, it must be cleaned with a dry cloth before installing. Skin oil residue on the bulb will shorten the life of the bulb.

To replace the headlight bulb, use the following procedure.

1. Disconnect the wiring harness; then remove the rubber boot from the light assembly.

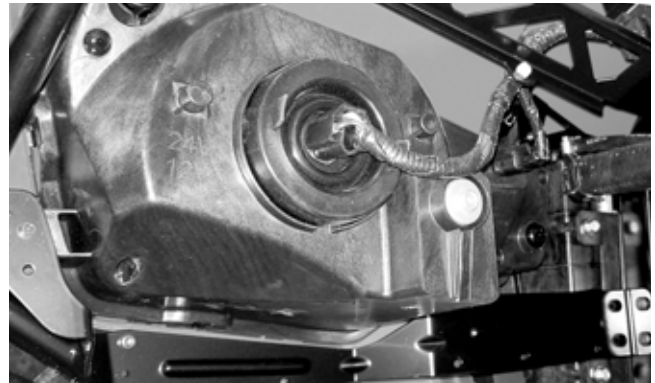

MOD046

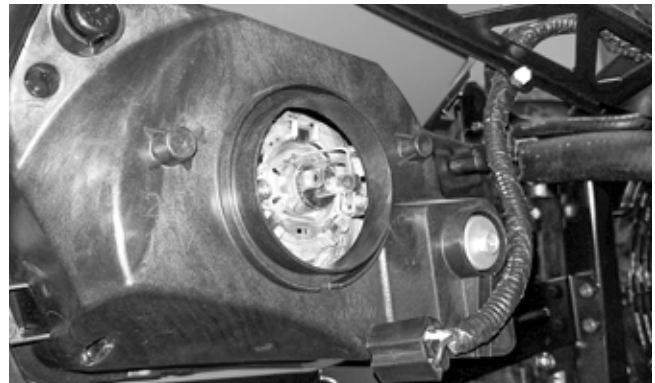

MOD096

CAUTION

When replacing the headlight bulb, be careful not to touch the glass portion of the bulb. Grasp the new bulb with clean rubber gloves.

2. Remove the old H4 bulb by unlocking the spring; then insert the new bulb into headlight assembly and lock the spring to secure the bulb.



MOD097A

3. Install the rubber boot making sure it is sealed around the bulb and connect the wire harness.



MOD098A

4. Adjust the headlight (see Checking/Adjusting Headlight Aim in this sub-section).

Taillight/Brake Light Assembly

If one or more individual LED bulbs are not working, the taillight/brake light assembly must be replaced.



MOD096

To replace the taillight/brake light assembly, use the following procedure:

1. Remove the four screws from the inner cargo box side panel, two rear tie-down screws and one tailgate latch bail screw; then remove the six screws from the underside of the cargo box and remove the outer cargo box side panel.

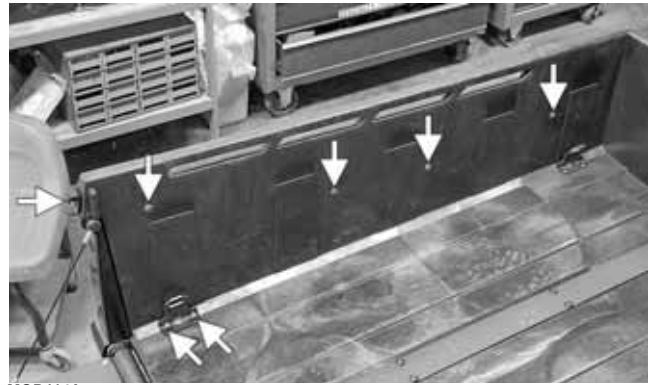

MOD114A



MOD115A

2. Remove screw (A); then flex the cargo box fender away from the cargo box to access and remove screw (B).

■NOTE: A long extension with a T25 socket or long T25 screwdriver will be needed to access screw (B).

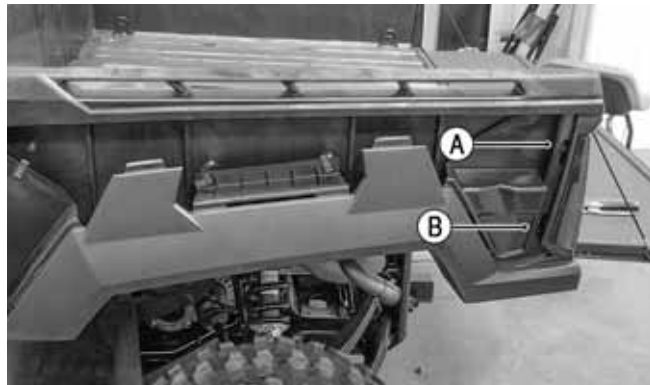

MOD117A

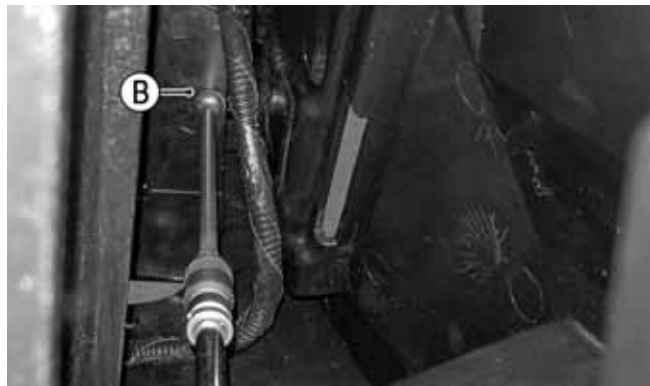

MOD113

3. Remove the taillight/brake light assembly and disconnect it from the harness by pushing on the connector lock.



MOD110



MOD112A

4. Install the new assembly, making sure to connect the harness.



MOD112

5. Install screw (A) first; then flex the cargo box fender away from the cargo box to access and install screw (B).

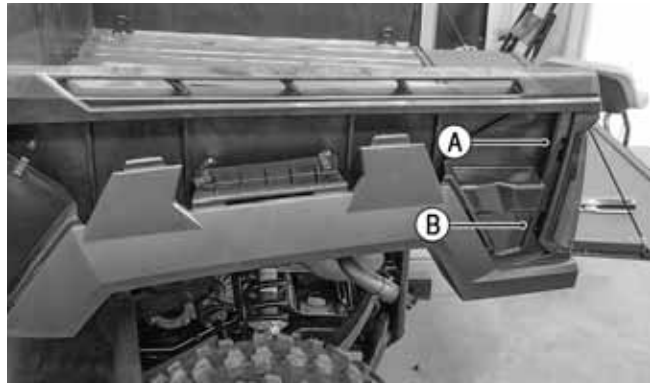

MOD117A

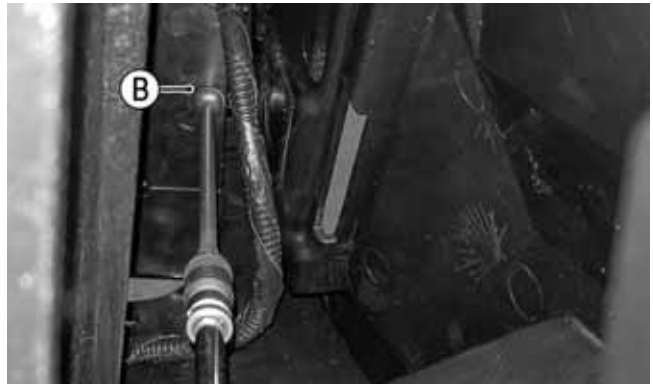

MOD113

6. Position the outer cargo box side panel behind the two tabs on the cargo box fender; then fit all tabs into their adjoining slots in the side panel.

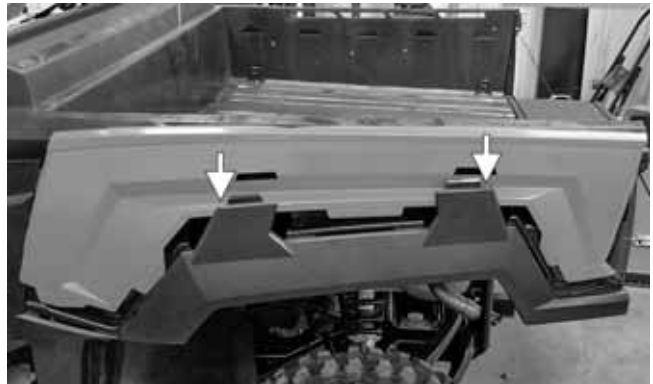

MOD116A

7. With a suitable pry bar, lift up on the inner cargo box floor near the rear corner.

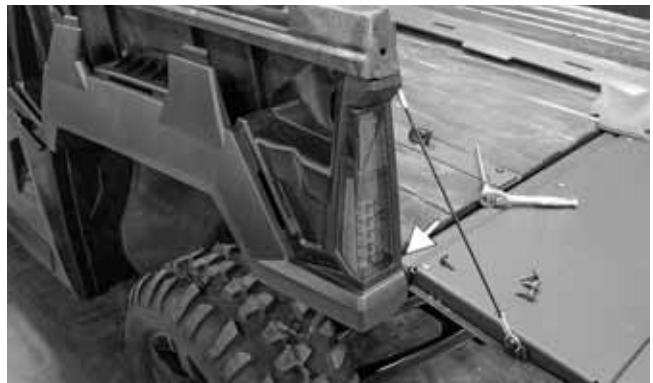

MOD110A

- Start at the rear of the cargo box and tuck the outer side panel under the cargo box floor and work it into place from back to front.



- Once the outer side panel is in place, install the screws securing the cargo box fender and outer side panel.

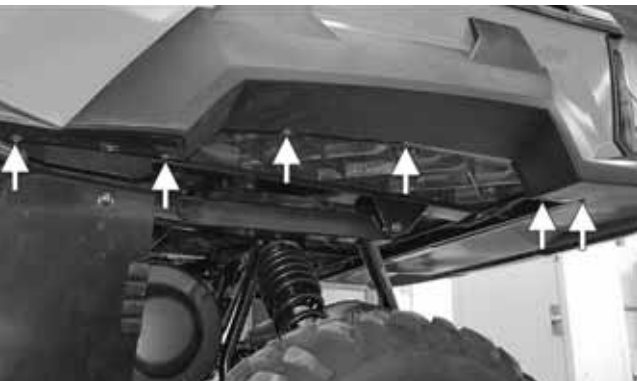
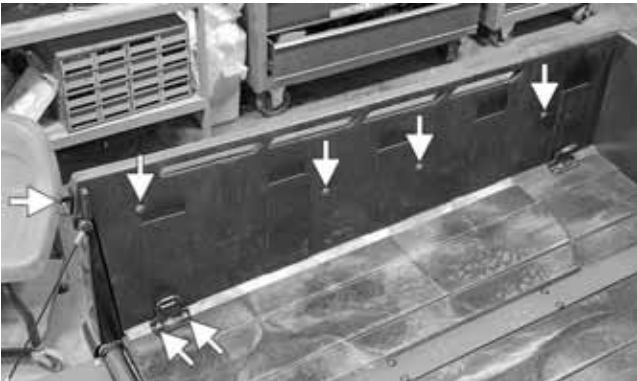

Checking/Adjusting Headlight Aim

The headlights can be adjusted vertically. The geometric center of the HIGH beam light zone is to be used for aiming.

- Position the vehicle on a level floor so the headlights are approximately 6.1 m (20 ft) from an aiming surface (wall or similar aiming surface).

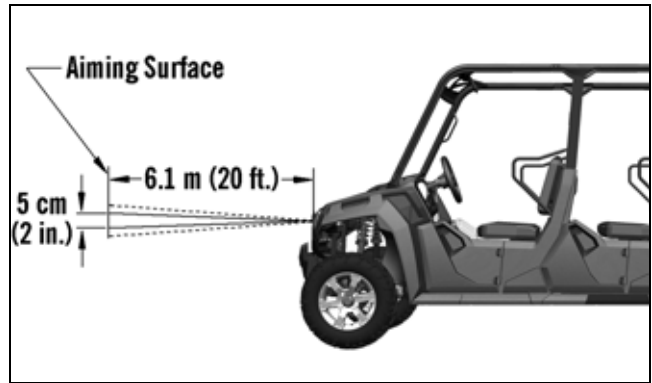

■NOTE: There should be an average operating load on the vehicle when adjusting the headlight aim.

- Measure the distance from the floor to the midpoint of each headlight.
- Using the measurements obtained in step 2, make horizontal marks on the aiming surface.
- Make vertical marks which intersect the horizontal marks on the aiming surface directly in front of the headlights.
- Switch on the lights. Make sure the HIGH beam is on. DO NOT USE LOW BEAM.
- Observe each headlight beam aim. Proper aim is when the most intense beam is centered on the vertical mark 5 cm (2 in.) below the horizontal mark on the aiming surface.
- Turn the headlight adjustment cap screw clockwise to adjust the headlight aim down or counterclockwise to adjust the headlight aim up.

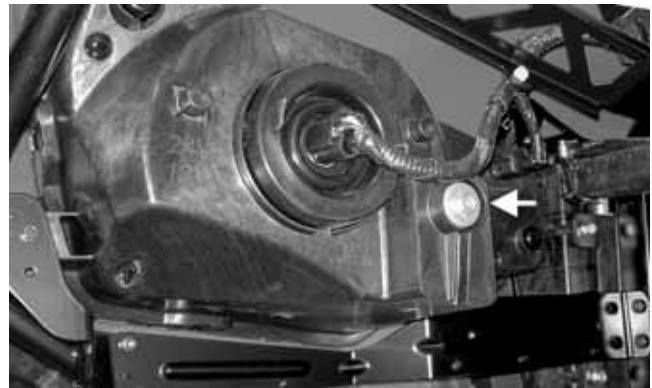

Shift Cable

CHECKING SHIFT CABLE

Turn the ignition switch on; then shift the transmission into park. The letter P should illuminate on the LCD gauge and the park icon (P) should illuminate. The vehicle should not be able to move.



MOD207

Move the shift lever all the way back. The letter L should illuminate on the LCD gauge.



MOD208

If either park or low range cannot be reached, the shift cable must be adjusted.

ADJUSTING SHIFT CABLE

1. Secure the vehicle on a support stand to elevate the wheels; then place the transmission in neutral; then rotate the rear wheels by hand at least two revolutions.

WARNING

Make sure the vehicle is solidly supported on the support stand to avoid injury.

2. Tilt the cargo box up; then remove the passenger-side rear inner fender. With the gear selector in neutral, measure the distance on each side of the upper tilt steering wheel adjuster bracket and the shifter housing.

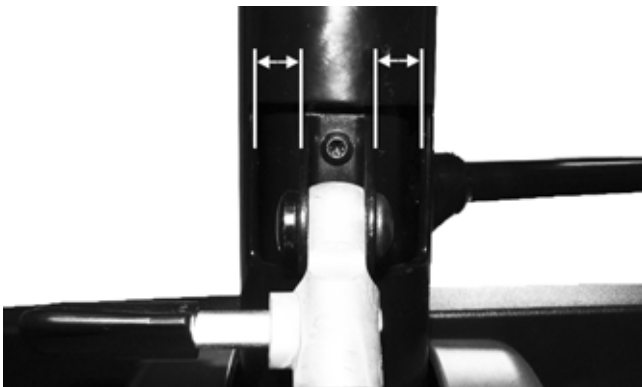

MOD520

■**NOTE:** If the distance on each side of the upper tilt steering wheel adjuster bracket and the shifter housing is the same and the vehicle does not properly engage Park or Low, shift cable replacement may be required.

3. Loosen nuts (A) and (B) and adjust the cable housing until the measurements on each side of the upper tilt steering wheel adjuster bracket are the same.

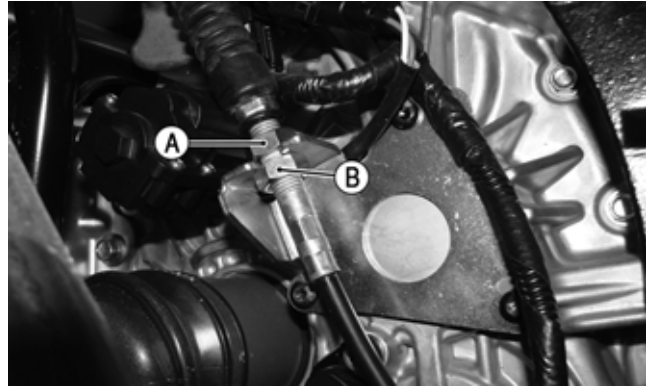

MOD297

4. Tighten the nuts (A) and (B) to 20 ft-lb (27.2 N-m).
5. Check each gear shift position for proper gear selection and make sure the proper icon illuminates on the LCD.

Hydraulic Brake System

■**NOTE:** This ROV/UTV is equipped with hydraulic brakes at all four wheels.

CHECKING/BLEEDING

The hydraulic brake system has been filled and bled at the factory.

1. With the master cylinder in a level position, check the fluid level in the reservoir. If the level in the reservoir is not above the MIN, add DOT 4 brake fluid.

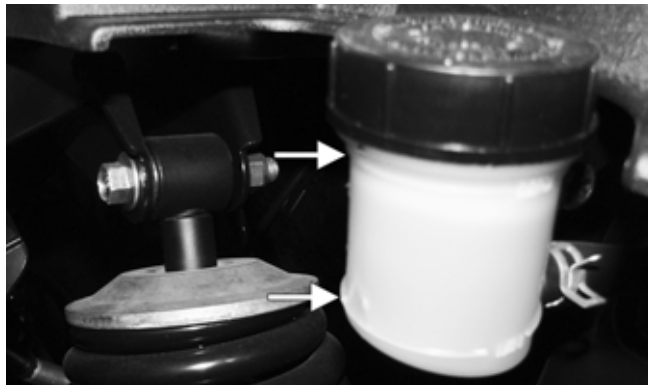

MOD163

2. Depress the brake pedal several times to check for a firm brake. If the brake is not firm, the system must be bled. To bleed the brake system, use the following procedure:
 - A. Remove the cover and fill the reservoir with DOT 4 brake fluid; then install and secure the cover.

- B. Slowly depress the brake pedal several times.
- C. Install one end of a clear hose onto the RIGHT REAR bleeder screw and direct the other end into a container; then while holding slight pressure on the brake pedal, open the bleeder screw and watch for air bubbles. Close the bleeder screw before releasing the brake pedal. Repeat this procedure until no air bubbles are present.

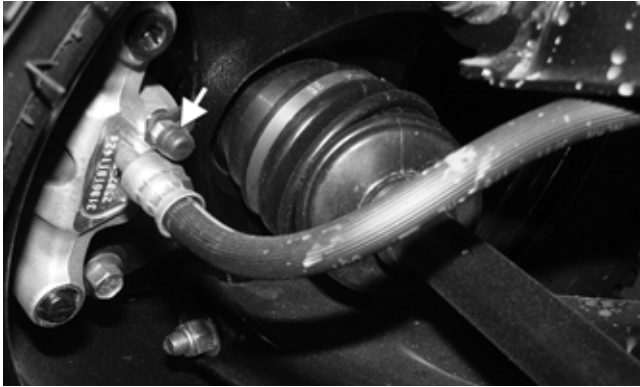

MOD299



MOD300

■ **NOTE:** During the bleeding procedure, watch the reservoir very closely to make sure there is always a sufficient amount of brake fluid. When the level falls below MIN, refill the reservoir before the bleeding procedure is continued. Failure to maintain a sufficient amount of fluid in the reservoir will result in air in the system.

- D. At this point, perform steps B and C on the REAR LEFT bleeder screw; then move to the FRONT RIGHT bleeder screw and follow the same procedure. Finally, complete the procedure on the FRONT LEFT bleeder screw.

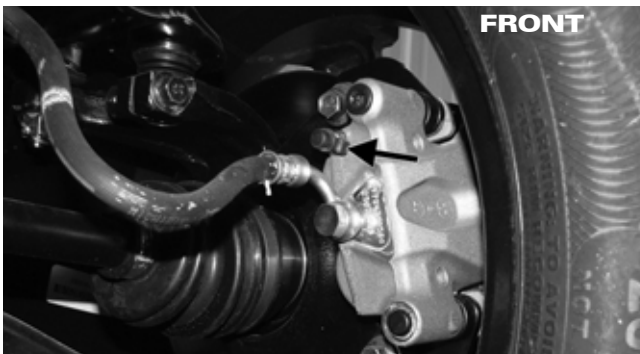

MOD161

- E. Repeat steps B and C until the brake pedal is firm.

- 3. Carefully check the entire hydraulic brake system to ensure all hose connections are tight, the bleed screws are tight, the protective caps are installed, and no leakage is present.

| |
|--------------------------------------------------------------------------------------------------------------------------------------------------------------------------------------|
| CAUTION |
| This hydraulic brake system is designed to use DOT 4 brake fluid only. If brake fluid must be added, care must be taken as brake fluid is very corrosive to painted surfaces. |

INSPECTING HOSES

Carefully inspect the hydraulic brake hoses for cracks or other damage. If found, the brake hoses must be replaced.

CHECKING/REPLACING PADS

The clearance between the brake pads and brake discs is adjusted automatically as the brake pads wear. The only maintenance that is required is replacement of the brake pads when they show excessive wear. Check the thickness of each of the brake pads as follows.

- 1. Remove the wheel corresponding to the brake being checked.
- 2. Measure the thickness of each brake pad.

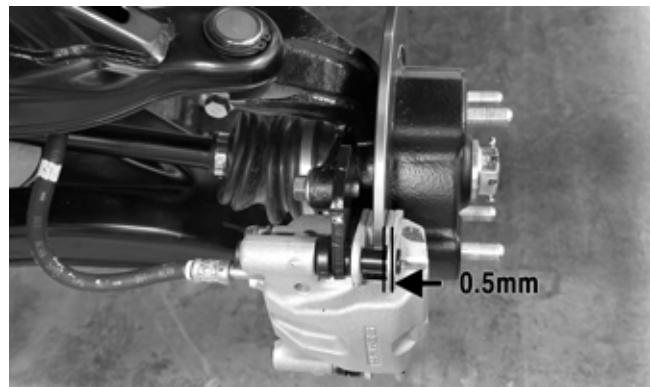

MOD081A

- 3. If thickness of either brake pad friction material is less than 0.5 mm (0.019 in.), the brake pads must be replaced.

■ **NOTE:** The brake pads should be replaced as a set.

- 4. To replace the brake pads, use the following procedure:
 - A. Remove the Torx head plug from the caliper; then remove the cap screws securing the caliper holder to the knuckle.



MOD512

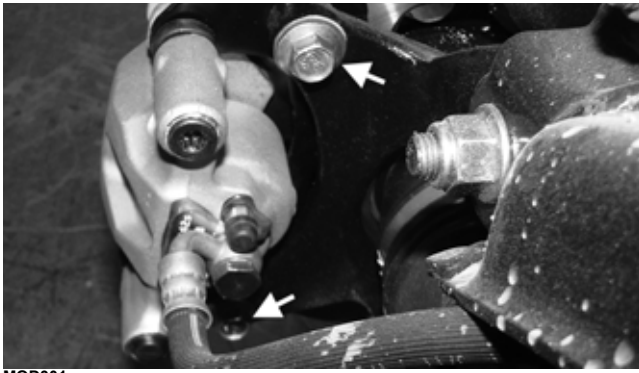

MOD301

- B. Remove the pads from the caliper; then install the new brake pads.



MOD302

- C. Secure the caliper holder to the knuckle with new "patch-lock" cap screws. Tighten to 45 ft-lb (61.2 N-m); then install the Torx head plug to the caliper.

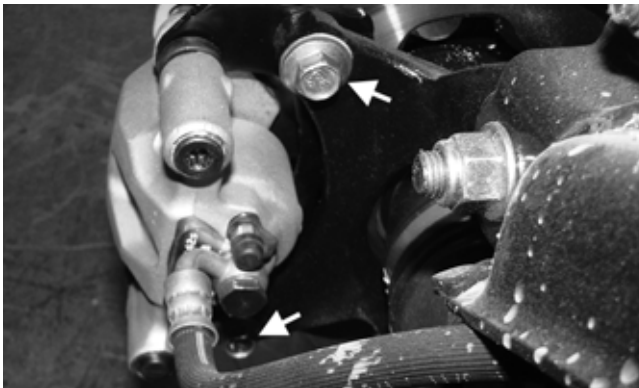

MOD301



MOD512

5. Install the wheels and using a crisscross pattern, tighten the wheel nuts in 20 ft-lb (27.2 N-m) increments to a final torque of 100 ft-lb (136 N-m).

6. Burnish the brake pads.

BRAKE DISC

Using a micrometer, measure the thickness of the brake disc in the contact surface. If thickness is 0.125 in. (3 mm) or less, the disc must be replaced. To replace the brake disc, see Drive System – Hub/Brake Disc.

Burnishing Brake Pads

Brake pads must be burnished to achieve full braking effectiveness. Braking distance will be extended until brake pads are properly burnished.

⚠ WARNING

Do not attempt sudden stops or put yourself into a situation where a sudden stop will be required until the brake pads are properly burnished.

1. Choose an area large enough to safely accelerate the vehicle to 30 mph (48 km/h) and to brake to a stop.
2. Accelerate to 30 mph (48 km/h); then release the accelerator pedal and depress the brake pedal to decelerate to 0-5 mph (0-8 km/h). Stopping distance should be approximately 50 ft (15 m).
3. Repeat procedure 20 times.

⚠ WARNING

Using the Operator's Manual as a guide, instruct the operator on the proper use, care, burnishing procedure (when brake pads are new), and maintenance of the hydraulic brake system.

Checking/Replacing Drive Belt

REMOVING

1. Tilt the cargo box up.
2. Remove the rear driver side inner fender by rotating the 1/4-turn fasteners counterclockwise.



MOD606

3. Loosen the clamp that holds the snorkel portion to the air inlet; then disconnect snorkel portion from air inlet.

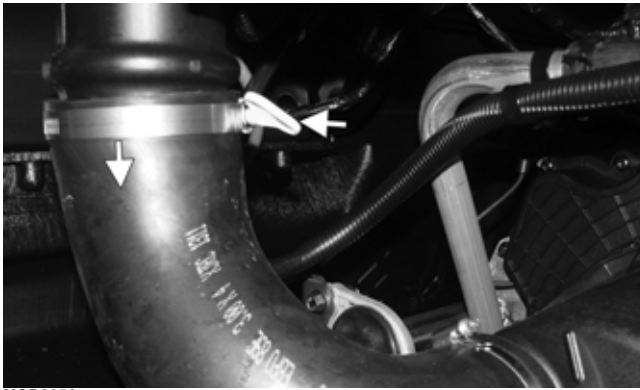

MOD205A

4. Remove the six clamps securing the clutch cover; then remove clutch cover.

■NOTE: Firmly grasp clamps as they can completely detach from clutch cover assembly and spring away.



MOD533

5. Using the Drive and Driven Clutch Holder Tool to hold the driven clutch remove the cap screw securing the driven clutch.



MOD599

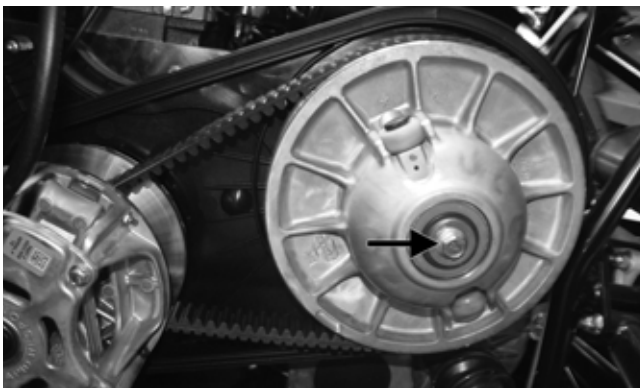

MOD213

6. Remove the belt by pulling it over the driven clutch and rotating the driven clutch.

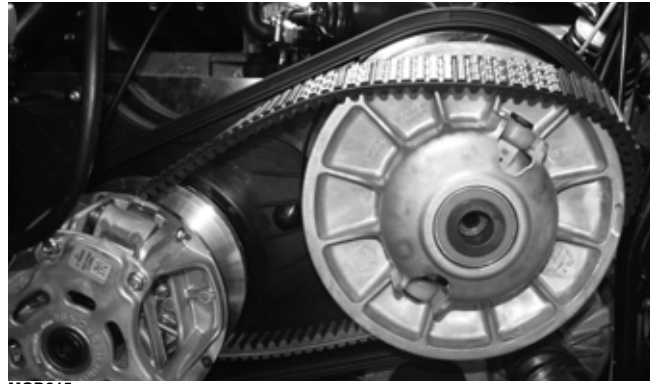

MOD215

CHECKING

Inspect the belt for any abnormal wear. Measure across the top of the drive belt (in multiple locations) using a Vernier caliper. Do not squeeze the belt as doing so may produce an inaccurate measurement. The drive belt must be at least 30 mm (1.18 in.) at any point.

INSTALLING

■NOTE: The arrows on the drive belt should point in direction of engine rotation (forward).

1. Place the drive belt over the drive clutch and put over the top of the driven sheaves.

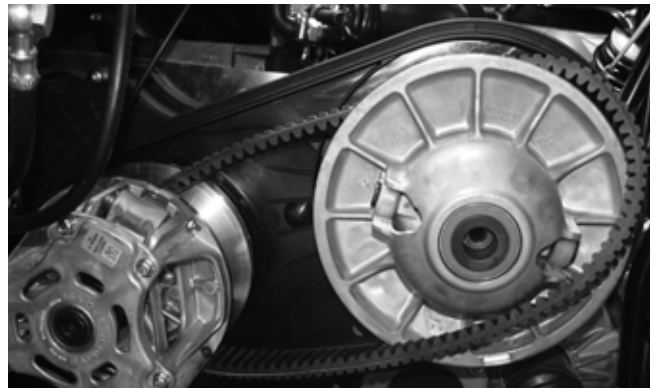

MOD216

2. Push in on the outer portion of the driven clutch while rotating counterclockwise. Insert the cap screw with the washer bevel cup side toward the clutch and hand tighten with no tools.

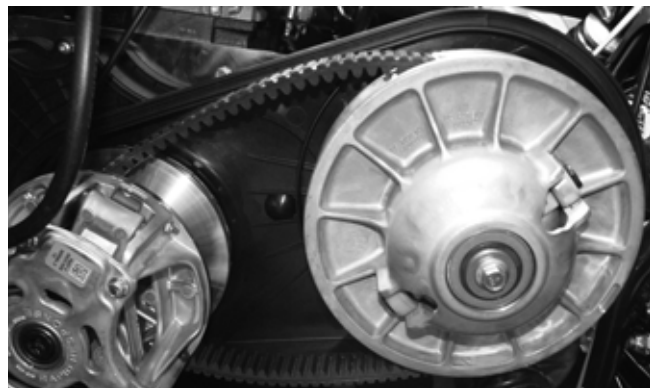

MOD217

- Continue to push in and rotate the driven clutch counterclockwise while continually tightening the cap screw.
- When the belt has reached the outermost portion of the driven clutch tighten the cap screw to 60 ft-lb (81.6 N-m) while holding the driven clutch with the Drive and Driven Clutch Holder Tool.

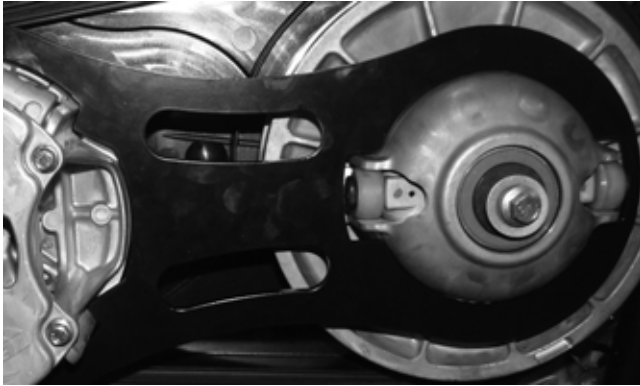

MOD599

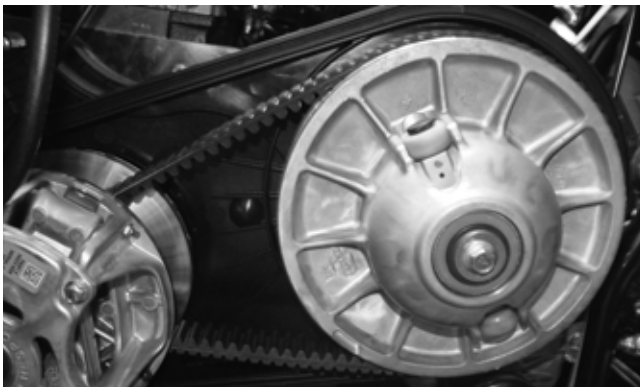

MOD218

- Rotate the driven clutch counterclockwise at least two times to verify belt is in the outermost portion of the sheave. Torque the cap screw to 60 ft-lb (81.6 N-m) while holding the driven clutch with the Drive and Driven Clutch Holder Tool

CAUTION

It is crucial to rotate the driven clutch counterclockwise at least two times and torque the driven cap screw after the initial torque.

- The belt should be as shown on the driven sheave.



MOD219

- Install the clutch cover making sure the gasket is completely in the groove on the engine side. Install six clamps securing the clutch cover



MOD533

- Connect clutch air inlet to snorkel portion; then install the clamp that holds the snorkel portion to the air inlet.



MOD205B

- Reinstall the rear driver-side inner fender and secure by rotating the quarter turn fasteners clockwise.



MOD606

Steering/Body/Controls

The following steering components should be inspected periodically to ensure safe and proper operation:

- A. Steering wheel secure.
- B. Steering has equal and complete full-left and full-right turning capability.
- C. Steering sector mounting bolts tight.
- D. Ball joints not worn, cracked, or damaged.
- E. Tie rods not bent or cracked.
- F. Knuckles not worn, cracked, or damaged.
- G. Cotter pins not damaged or missing.
- H. Steering wheel tilt locks securely.

The frame and welds should be checked periodically for damage, bends, cracks, deterioration, broken components, and missing components.

Steering Wheel

REMOVING

1. Remove the steering wheel cover; then match mark the steering shaft and steering wheel.

■NOTE: Any time steering components are disassembled, all connecting components should be marked for proper alignment during assembling.

2. Remove the lock clip from the steering shaft; then remove the nut securing the steering wheel and remove the steering wheel.

INSPECTING

1. Inspect the steering wheel for cracks, missing padding, or broken spokes.
2. Inspect the splines for wear.
3. Check that the steering wheel is not bent.

INSTALLING

1. Install the steering wheel aligning the two match marks; then apply a drop of red Loctite #271 to the threads of the nut and secure the steering wheel. Tighten to 25 ft-lb (34 N-m).

■NOTE: If a new steering wheel is being installed, mark the wheel as close as possible to the old wheel mark; then check for proper positioning with the front wheels straight forward.

2. Install the lock clip on the steering shaft; then install the steering wheel cover.

■NOTE: If the hole in the steering shaft does not align with the slots in the castle nut, tighten the nut slightly until the next slot aligns with the hole.



MOD220

Steering System

REMOVING EPS ASSEMBLY

■NOTE: Thoroughly troubleshoot the electronic steering system (EPS) system (if equipped) prior to replacing the EPS assembly (see Electrical System — Electronic Power Steering (EPS)) as there are several possible external causes for system failure.

■NOTE: The EPS assembly is only serviceable as an assembly.

1. Disconnect the battery; then remove the hood, upper hood, dash upper and dash lower; then disconnect the EPS electrical connection.



MOD269

2. Align the steering rack with the marks with the wheels straight ahead.

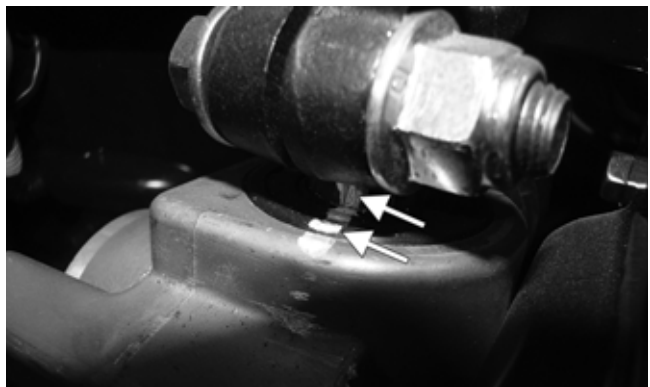

MOD173

3. Remove the input shaft cap screw and lock nut of the EPS; then remove the output shaft cap screw and nut of the EPS. Discard lock nuts. Inspect cap screws and replace if damaged.



MOD270A

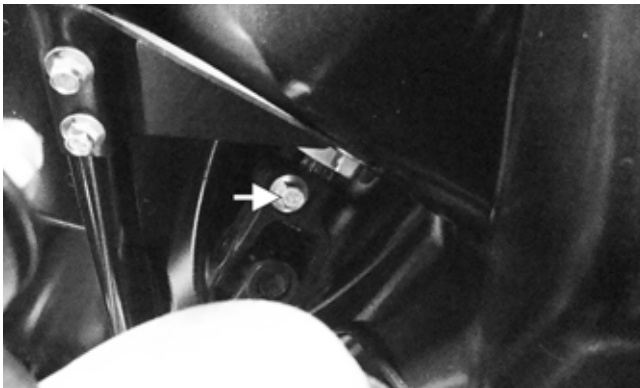

MOD271

4. Remove the two cap screws securing the steering tilt assembly; then pull the U-joint off of the input shaft of the EPS; then secure the steering tilt assembly out of the way.



MOD272

5. Remove the two cap screws on the occupant side and the one cap screw in the front left inner fender securing the EPS; then gently remove the EPS taking note that the output shaft should slide away from the U-joint.

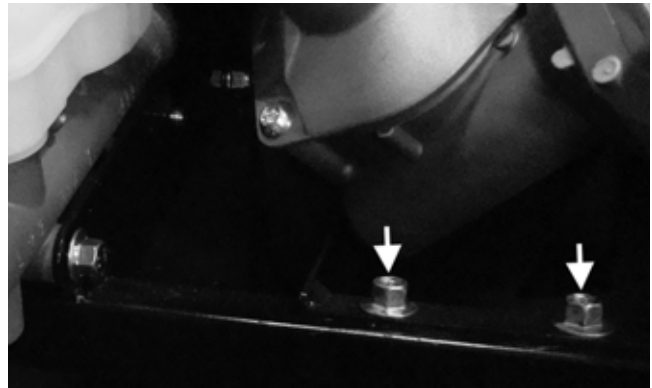

MOD274

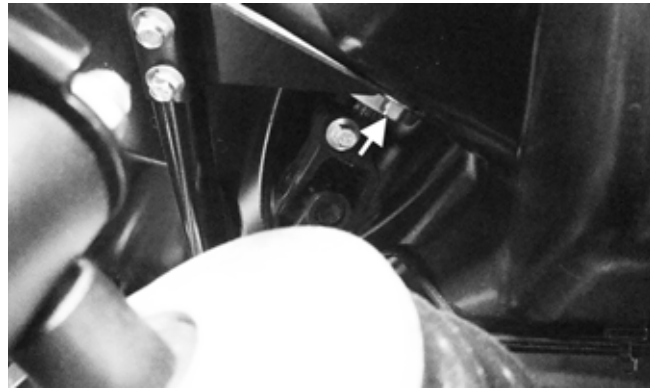

MOD273

INSTALLING STEERING SHAFT/EPS ASSEMBLY

■NOTE: Both the input and output shafts of the EPS have a notch that will only align one way with the U-joints.

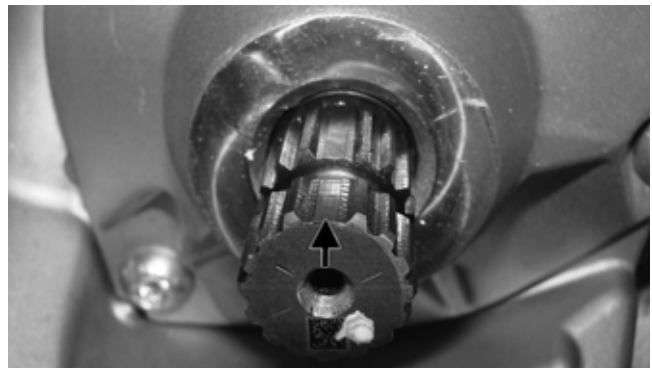

MOD275

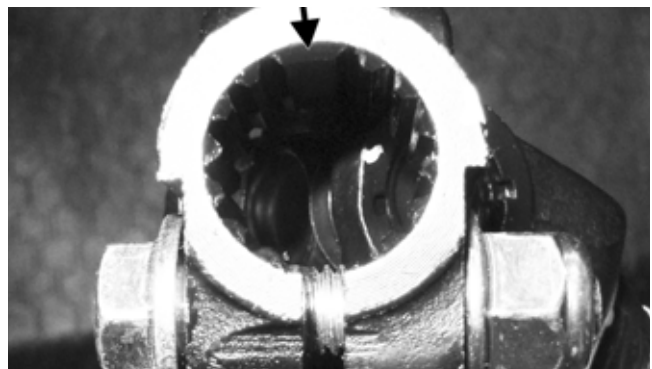

MOD276

1. Align the steering rack with the marks; then reinstall the output shaft of the EPS into the U-joint going to the steering rack; then install the EPS into position.

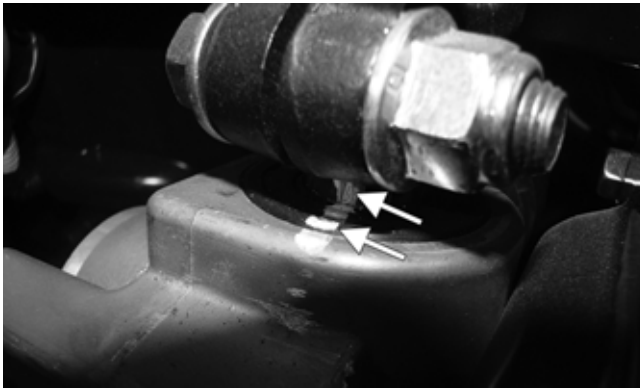

MOD173

2. Reinstall the two cap screws on the occupant side and the one cap screw in the front left inner fender securing the EPS. Finger tighten only.

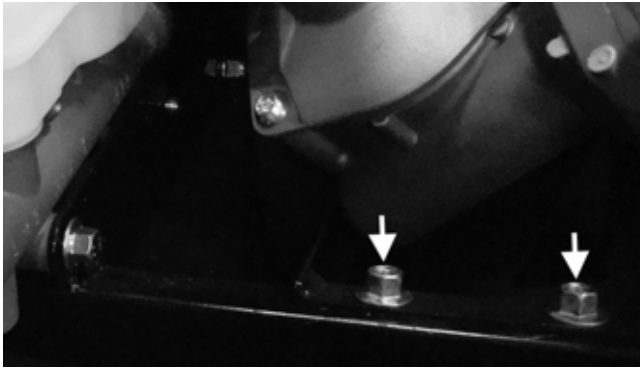

MOD274

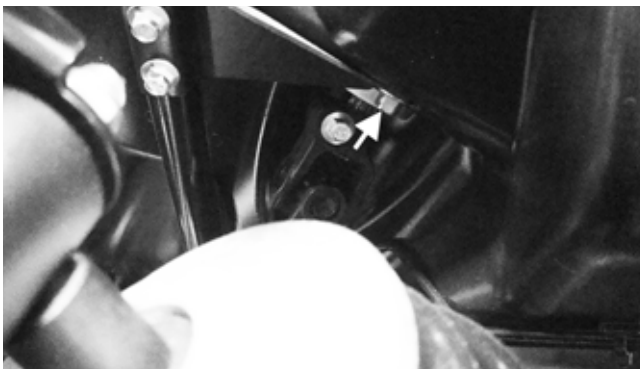

MOD273

3. Align the U-joint of the steering tilt assembly to the input shaft of the EPS; then reinstall the two cap screws and new lock nuts securing the steering tilt assembly. Tighten to 16 ft-lb (21.8 N-m).



MOD272

4. Reinstall the input shaft cap screw and new lock nut to the EPS; then reinstall the output shaft cap screw and new lock nut of the EPS. Tighten both to 24 ft-lb (32.6 N-m).



MOD270A



MOD271

5. Reconnect the EPS electrical connection with dielectric grease on the terminals; then tighten the cap screws from step 2 to 16 ft-lb (21.8 N-m); then reinstall the dash lower, dash upper, upper hood, and hood; then reconnect the battery.



MOD269A

REMOVING RACK AND PINION

■NOTE: The steering rack should be aligned with the factory marks and marked on the U-joint prior to removal.

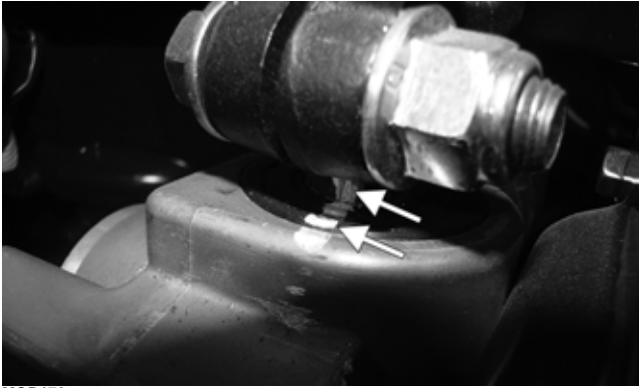

MOD173

1. Using a suitable lift and stands lift the vehicle until the front wheels are off the ground; then remove the front wheels.
2. Remove the cotter pins (A) and castle nuts (B) securing the outer tie rod ends to the knuckles; then remove the outer tie rod ends from the knuckles.

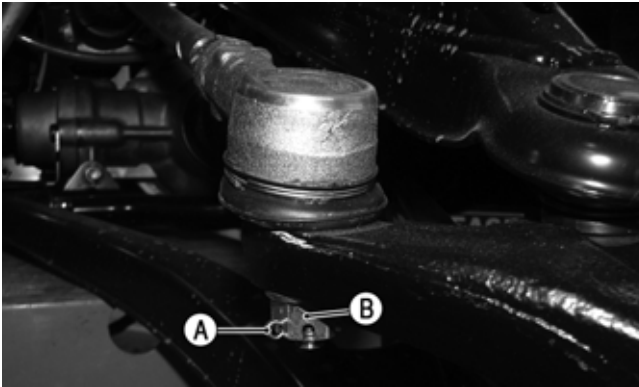

MOD315

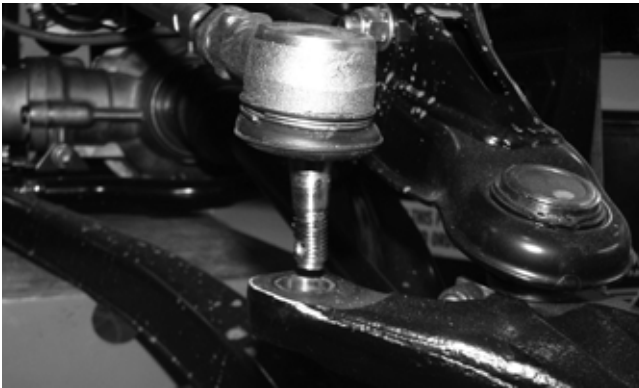

MOD316

3. Remove the cap screw and lock nut securing the U-joint to the rack and pinion. Discard lock nut. Inspect cap screw and replace if damaged.

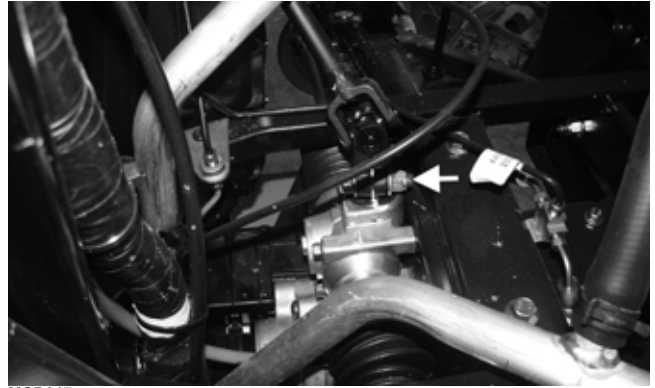

MOD317

4. Remove the four cap screws and lock nuts securing the rack and pinion bracket to the frame. Discard lock nuts. Inspect cap screws and replace if damaged.

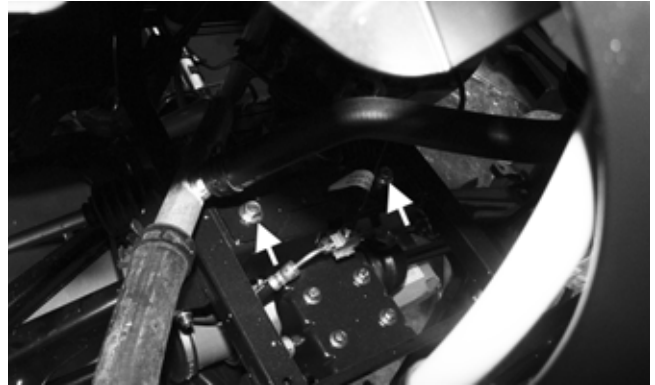

MOD319

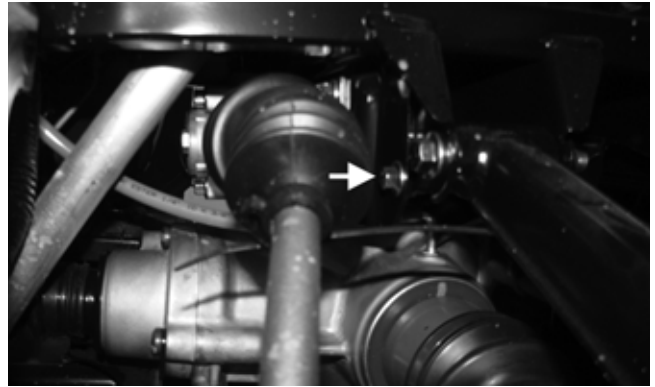

MOD320



MOD321

5. Disconnect the U-joint from the rack and pinion; then remove the rack and pinion from the passenger side.

INSPECTING RACK AND PINION

1. Inspect the tie rod ends for damaged threads, torn boots, or excessive wear.
2. Inspect the tie rods for bends or deformation.
3. Inspect the rack and pinion-to-tie rod boots for tears or deterioration.



MOD322

4. Check boot clamps for security.
5. Check that the steering assembly operates smoothly with no binding from full-left to full-right position.
6. Inspect for grease seepage from the steering assembly.

■NOTE: The steering assembly (rack and pinion) is not repairable and must be replaced as an assembly; however, the tie rods and boots are replaceable.

INSTALLING RACK AND PINION

1. From the passenger side, install the rack and pinion; then line up marks on the U-joint with the rack and pinion; then connect the U-joint to the rack and pinion. Install the bolt securing the U-joint to the rack and pinion. Tighten to 45 ft-lb (61.2 N-m).
2. Install the four cap screws and new lock nuts securing the rack and pinion bracket to the frame. Tighten the upper cap screws to 45 ft-lb (61.2 N-m) and the lower cap screws to 16 ft-lb (21.8 N-m).



MOD319

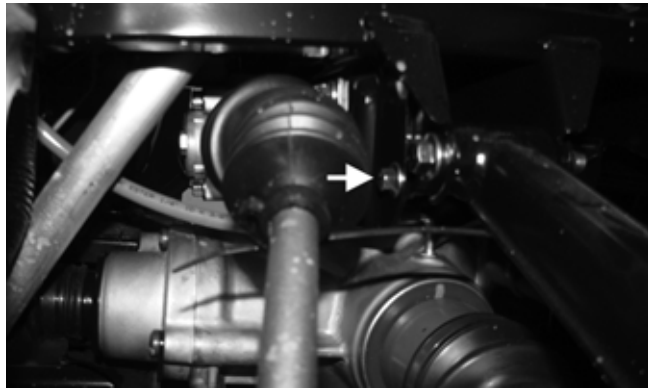

MOD320

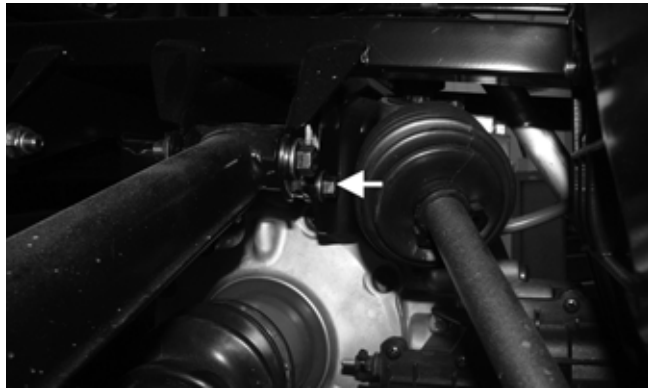

MOD321

3. Place the outer tie rod ends into the knuckles and secure with the castle nuts (B) (coated with red Loctite #271). Tighten to 32 ft-lb (43.5 N-m); then install new cotter pins (A) and spread the cotter pins.

■NOTE: If the slots in the castle nut (B) are not aligned with the hole in the outer tie rod end, tighten until the cotter pin can be installed.



MOD316

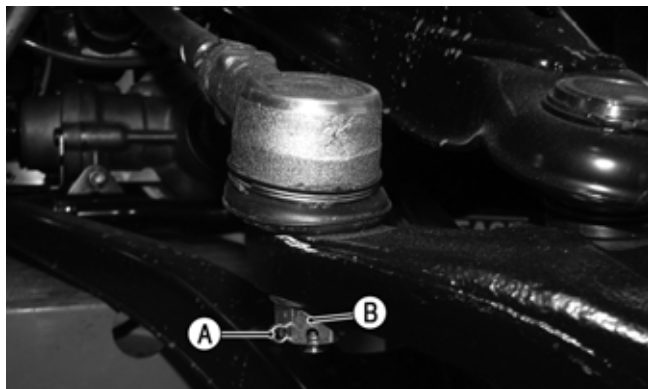

MOD315

4. Install the wheels and using a crisscross pattern, tighten the wheel nuts in 20 ft-lb (27.2 N-m) increments to a final torque of 100 ft-lb (136 N-m); then lower the vehicle and remove the suitable lift and stands.

REMOVING OUTER TIE RODS

■NOTE: Removal of the rack and pinion is not required to replace outer tie rods.

1. Using a suitable lift and stands lift the vehicle until the front wheels are off the ground; then remove the front wheels.
2. Remove the cotter pins (A) and castle nuts (B) securing the tie rod ends to the knuckles; then remove the outer tie rod ends from the knuckles.

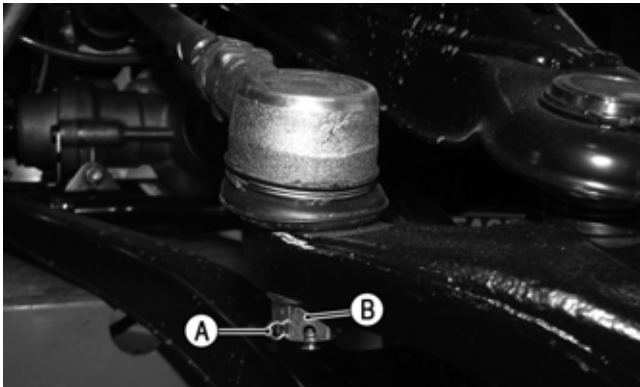

MOD315



MOD316

3. Measure the distance between shoulder of the tie rod shaft and the tie rod.

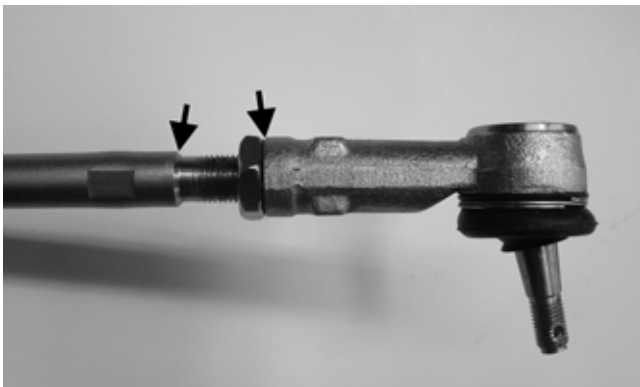

MOD323

4. Using a wrench, loosen the lock nut (B) while holding the tie rod at the location indicated (C); then remove the tie rod with a wrench at the location indicated (C) while holding the tie rod shaft at the location indicated (A).

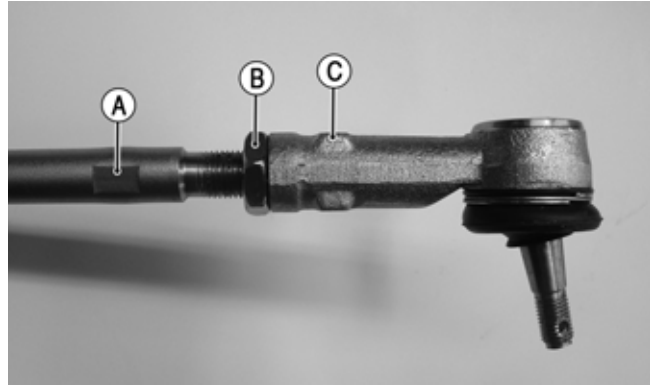

MOD323A

■NOTE: Tie rods come as a complete assembly. No further disassembly is required.

INSTALLING OUTER TIE RODS

■NOTE: If a new rack and pinion boot is to be installed. Install prior to putting on the outer tie rods.

1. Install the outer tie rod with a wrench at the location indicated (C) while holding the tie rod shaft at location indicated (A) until obtaining the measurement previously recorded when removing the outer tie rod.

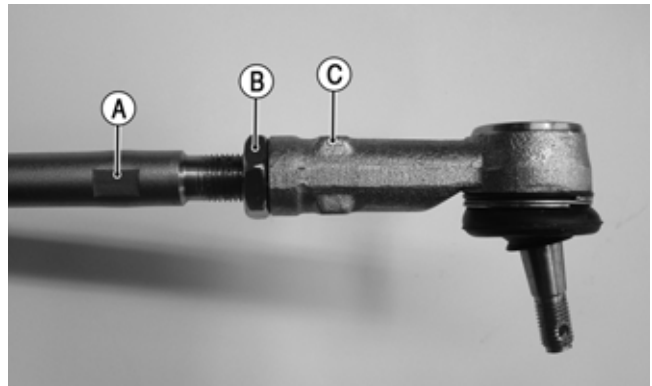

MOD323A

2. Hold the outer tie rod with a wrench at the location indicated (C) and tighten the lock nut (B).

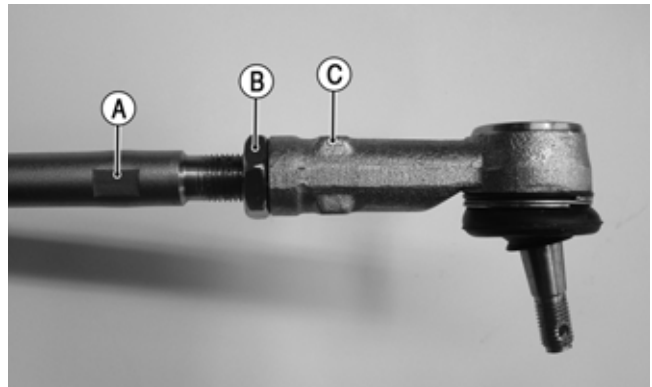

MOD323A

- Place the outer tie rod ends into the knuckles and secure with the castle nuts (B) (coated with red Loctite #271). Tighten to 32 ft-lb (43.5 N-m); then install new cotter pins (A) and spread the cotter pins.

■NOTE: If the slots in the castle nut (B) are not aligned with the hole in the outer tie rod end, tighten until the cotter pin can be installed.



MOD316

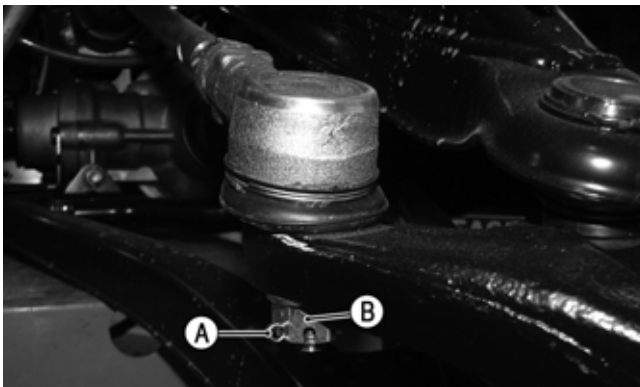

MOD315

- Install the wheels and using a crisscross pattern, tighten the wheel nuts in 20 ft-lb (27.2 N-m) increments to a final torque of 100 ft-lb (136 N-m); then lower the vehicle and remove the suitable lift and stands; then adjust the wheel alignment

REMOVING INNER TIE RODS

- Remove the rack and pinion from the vehicle.



MOD322

- Remove the inner boot clamp (A) and outer boot clamp (B) of the side being removed; then slide the boot toward the outer tie rod of the side being removed.

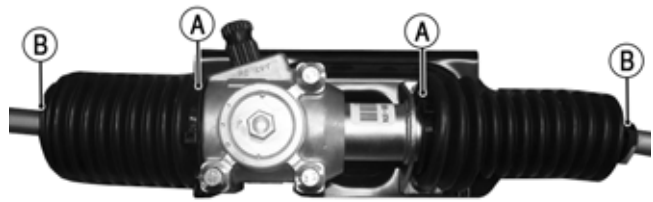

MOD322A

- Securely mount the rack and pinion to a vise or other holding fixture; then heat the inner tie rod; then with the inner tie rod still hot loosen and remove with an appropriate tool.

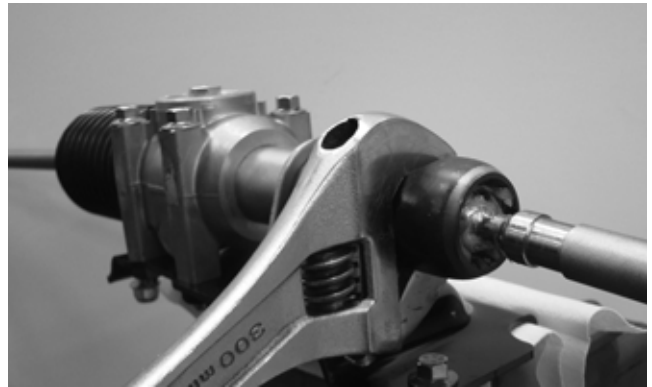

MOD324

INSTALLING INNER TIE RODS

- With the threads coated with red Loctite #271, thread the inner tie rod end onto the rack and tighten securely.

■NOTE: Always attach the crowfoot to the torque wrench with the open end 90° to the torque wrench handle to ensure accurate torque application.

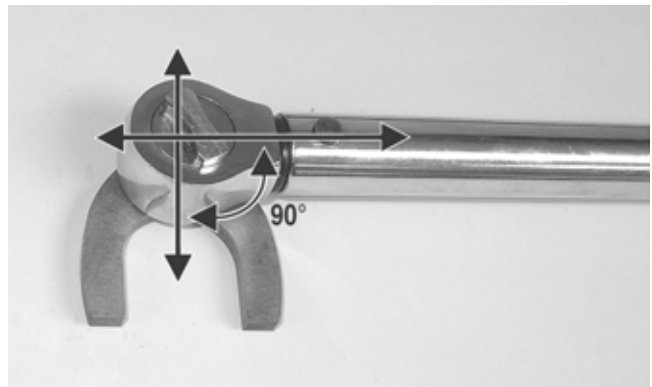

PR528A

- Install the boot onto the rack and secure with the inner (A) and outer (B) boot clamps.



MOD322A

3. Reinstall the rack and pinion into the vehicle; then install the wheels and using a crisscross pattern, tighten the wheel nuts in 20 ft-lb (27.2 N-m) increments to a final torque of 100 ft-lb (136 N-m); then lower the vehicle and remove the suitable lift and stands; then adjust the wheel alignment.
4. Lower the vehicle and remove the suitable lift and stands; then adjust the wheel alignment.

Steering Knuckles

REMOVING AND DISASSEMBLING

1. Secure the vehicle on a support stand to elevate the wheel; then remove the wheel and retaining plate.

⚠ WARNING

Make sure the vehicle is solidly supported on the support stand to avoid injury.

2. Remove the nut securing the hub.
3. Remove the brake caliper.
4. Remove the hub assembly.
5. Remove the cotter pin from the tie rod end and remove the tie rod end from the knuckle.
6. Remove the two cap screws securing the ball joints in the knuckle.

NOTE: Turn the cap screws and not the lock nuts. The lock nuts are held in place by the steering knuckle.

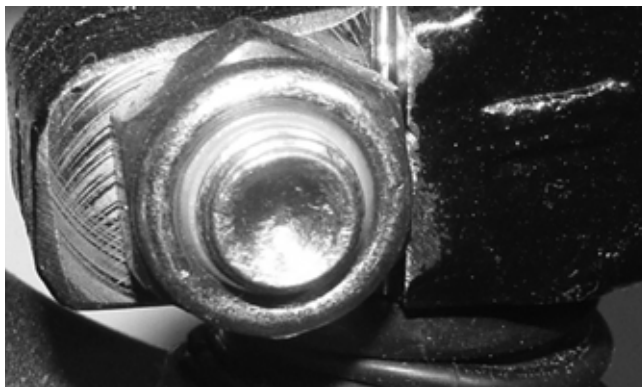

MOD326



MOD325

7. With the cap screws completely removed tap the ball joint end out of the knuckle; then remove the knuckle.
8. Remove the snap ring securing the bearing in the knuckle; then press the bearing out of the knuckle.



MOD327

CLEANING AND INSPECTING

1. Clean all knuckle components.
2. Inspect the bearing for pits, scoring, rusting, or premature wear.
3. Inspect the knuckle for cracks, breaks, or galling of the bearing surface.

ASSEMBLING AND INSTALLING

1. Using a suitable press and driver, press the bearing into the knuckle until firmly seated; then install the snap ring with the sharp edge away from the bearing.



MOD327

2. Insert the CV shaft into the knuckle; then install the knuckle to the upper and lower ball joints and secure with the two cap screws. Tighten to 45 ft-lb (61.2 N-m).



MOD325

3. Install the tie rod end and secure with the nut (coated with red Loctite #271). Tighten to 32 ft-lb (43.5 N-m); then install a new cotter pin and spread the pin.
4. Apply a small amount of molybdenum grease to the hub splines.

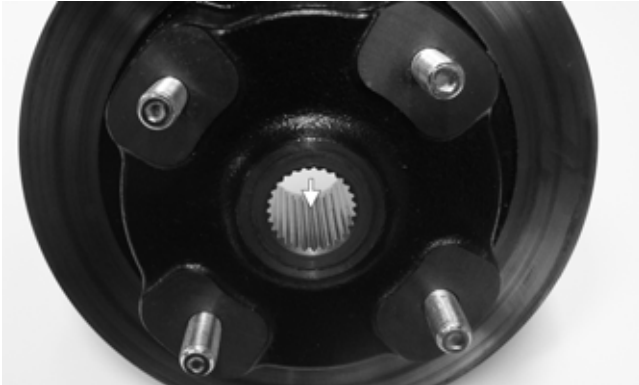

MOD328

5. Install the hub assembly onto the splines of the shaft.



MOD329

6. Using Hub Retaining Wrench, secure the hub assembly with the nut. Tighten to 250 ft-lb (339 N-m).

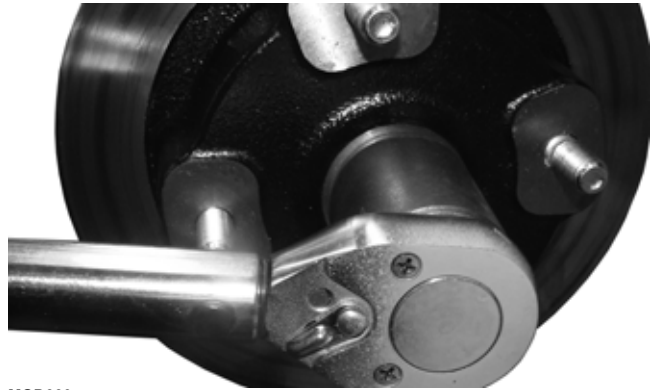

MOD330

7. Install the retaining plate.

■NOTE: If necessary, tighten the hub nut clockwise to allow the retaining plate to sit flush with the hub.



MOD331

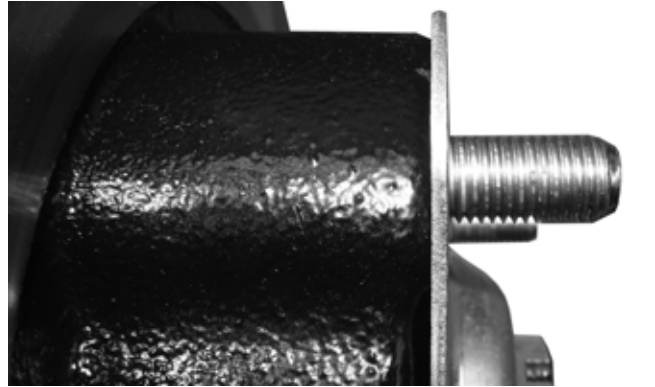

MOD332

8. Secure the brake caliper to the knuckle with the two new "patch-lock" cap screws. Tighten to 45 ft-lb (61.2 N-m).

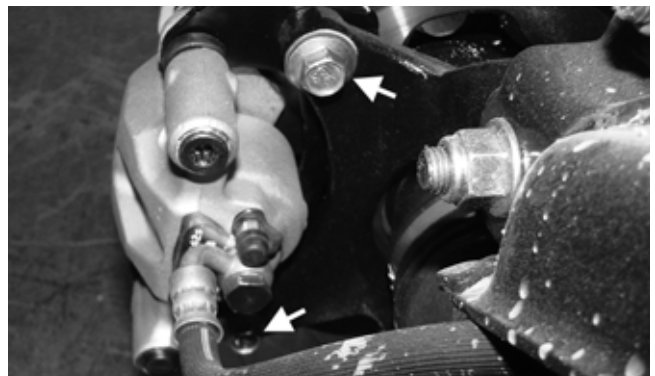

MOD301

9. Install the wheels and using a crisscross pattern, tighten the wheel nuts in 20 ft-lb (27.2 N-m) increments to a final torque of 100 ft-lb (136 N-m).
10. Remove the vehicle from the support stand.

Accelerator Pedal

REMOVING

Disconnect the connector from the accelerator pedal; then remove the two lock nuts from the inner fender securing the accelerator pedal assembly to the splash panel and remove the accelerator pedal. Discard lock nuts.

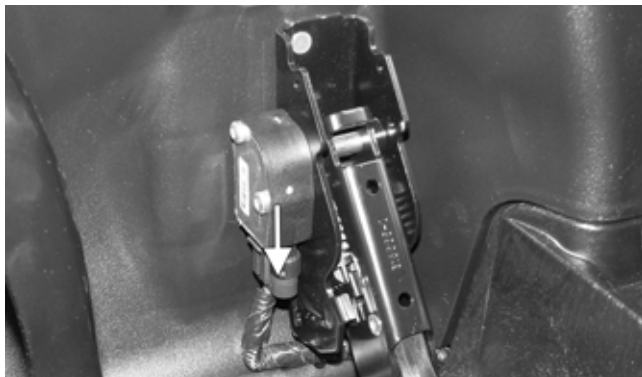

MOD534



MOD535

INSTALLING

Align the accelerator pedal studs with the holes in the splash panel and secure with the two new lock nuts from the inner fender; then tighten to 8 ft-lb (10.9 N-m); then connect the connector to the accelerator pedal.



MOD535

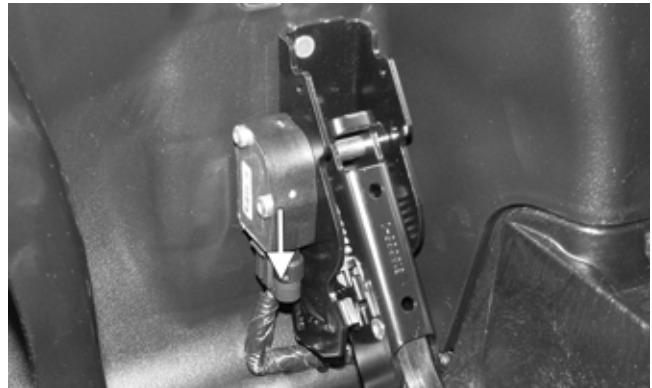

MOD534

Throttle Cable

This ROV/UTV is equipped with an Electronic Throttle Control (ETC) that does not have a traditional cable to control the throttle. The throttle is controlled by electrical wires. See the Electrical System section.

Shift Lever

REMOVING

1. Remove the steering wheel.
2. Remove the lower and upper steering adjuster cap screws; then remove steering adjuster. With a suitable strap secure the steering wheel tilt assembly up and out of the way.
3. Remove the cap screw and lock nut securing the shift cable to the shift lever. Discard lock nut. Inspect cap screw and replace if damaged.

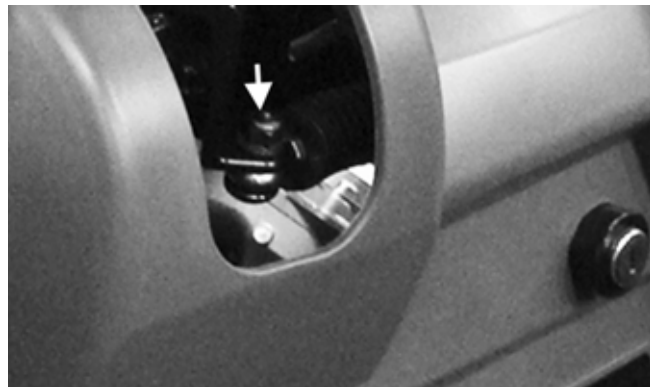

MOD305

4. Remove the two cap screws securing the adjuster bracket to the bottom of the steering housing.

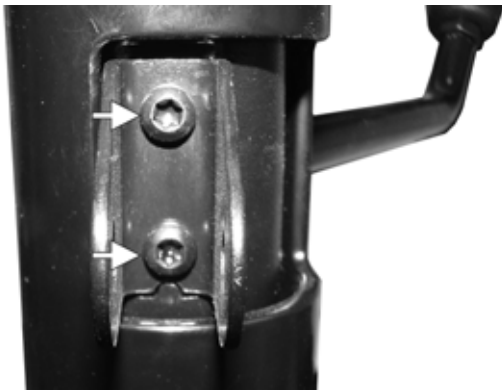

MOD306

5. Remove the snap ring on the steering column; then remove the washer (A) and thrust washer (B); then slide the shift lever off of the steering housing.

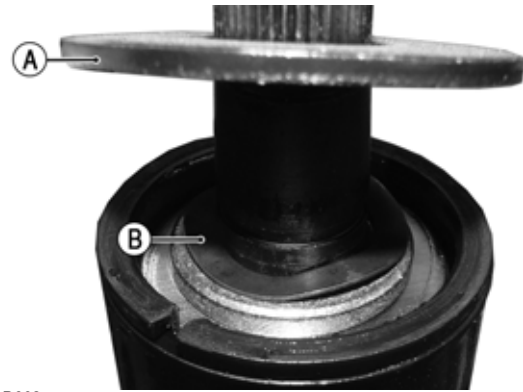

MOD308



MOD307

2. Install the adjuster bracket to the bottom of the steering housing; then install two the cap screws. Tighten to 24 in-lb (2.72 N-m).



MOD307

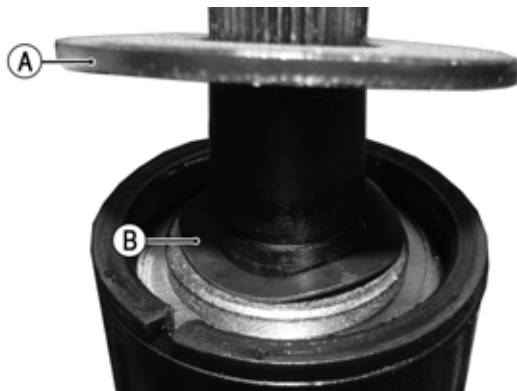

MOD308

INSTALLING

1. Lightly grease the inner portion of the shift lever; then slide the shift lever onto the steering housing; then install the thrust washer (B) and washer (A); then install the snap ring.

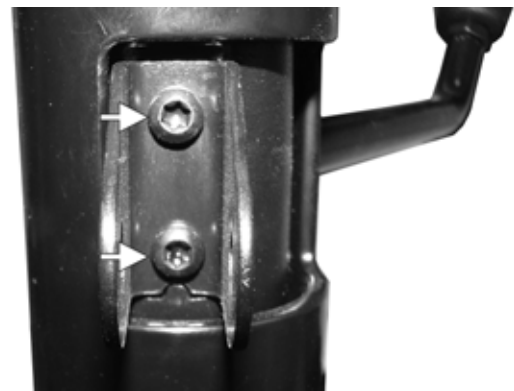

MOD306

3. Position the shift cable to the shift lever using the existing cap screw and a new lock nut. Tighten to 6 ft-lb (8.2 N-m).
4. Position the steering adjuster into place; then install the lower and upper steering adjuster cap screws. Tighten both to 6 ft-lb (8.2 N-m). Install the steering wheel. Tighten to 25 ft-lb (34 N-m).
5. Install the lock clip on the steering shaft; then install the steering wheel cover.

■NOTE: If the hole in the steering shaft does not align with the slots in the castle nut, tighten the nut slightly until the next slot aligns with the hole.



MOD220



MOD309

Shift Cable

REMOVING

■NOTE: The shift cable can be accessed from the top by removing the floor or from the bottom by removing the skid plate. Removing from the bottom in most cases will be easier.

1. Remove the mid/upper dashboard; then remove the skid plate; then remove the lower steering adjuster cap screw. With a suitable strap secure the steering wheel tilt assembly up and out of the way.
2. Remove the cap screw and lock nut securing the shift cable to the shift lever. Discard lock nut. Inspect cap screw and replace if damaged.

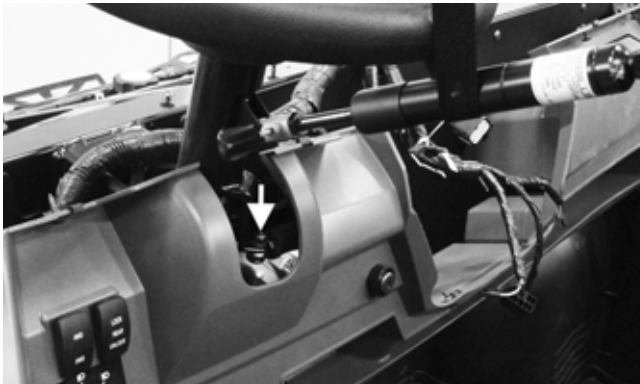

MOD304

3. Loosen the lock nut securing the shift cable (underneath the dashboard). Slide the shift lever to the front of the vehicle and out.

■NOTE: The shift cable has two flat spots where the threads are that must be toward the metal housing for removal.



MOD310



MOD303

4. Remove the E-clip securing the cable end to the shift arm stud.



MOD298

5. Loosen the adjuster nut; then remove the shift cable from the bracket. Remove any cable ties securing the shift cable to the chassis noting their location; then remove the shift cable.

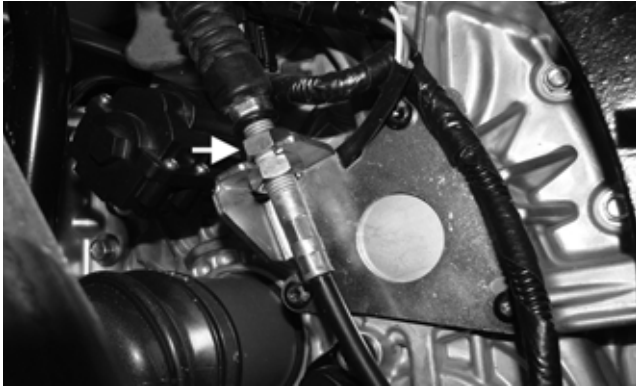

MOD297A

INSTALLING

1. Route the cable into position making sure there are no kinks or sharp bends.
2. Guide the shift cable into the shift cable bracket. Install the cable end to the shift arm stud and secure with a new E-clip. Secure the adjuster nut to the bracket.



MOD298

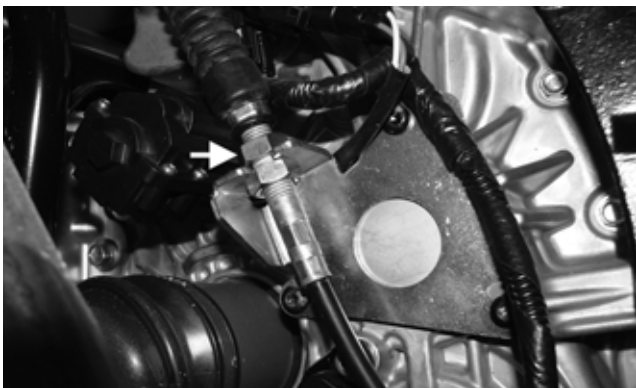

MOD297A

3. From under the dashboard, guide the shift cable into the bracket and install as shown; then secure the cable end to the shift lever using a new locknut. Tighten to 6 ft-lb (8.2 N-m) Tighten the shift cable nut to 20 ft-lb (27.2 N-m).



XX382

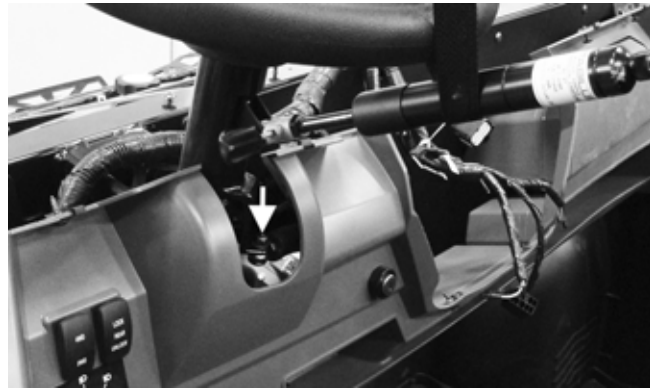

MOD304



MOD303

4. Fasten the shift cable to the chassis with the previously noted cable tie locations.
5. Shift the transmission through all positions making sure the each gear position illuminates the appropriate gears selected and that the Park Indicator illuminates only when fully in Park. Verify transaxle is in park by attempting to gently push the vehicle; then verify vehicle moves in low range without grinding gears. Adjust as necessary. If no adjustment is necessary tighten the adjuster nuts for the shifter cable on the transaxle to 20 ft-lb (27.2 N-m)
6. Install the mid/upper dashboard upper; then the skid plate; then the lower steering adjuster cap screw.

LCD Gauge

REMOVING/INSTALLING

To remove the gauge, pull out on one side of it; then disconnect the multi-pin connector and remove the gauge.

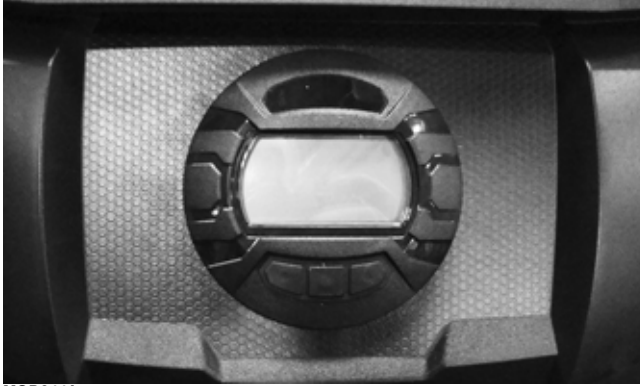

MOD244A

To install the gauge, connect the multi-pin connector and press the gauge into the dash.

■NOTE: Ensure the rubber mounting ring is oriented correctly on the tab and seats fully through the dash.

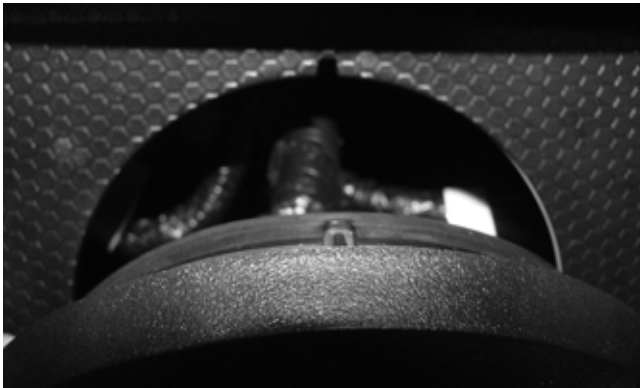

MOD241

Front Wheel Alignment

■NOTE: All measurements and adjustments must be made with the vehicle unloaded, steering rack aligned with marks, steering wheel as shown at mid tilt and both wheels straight.

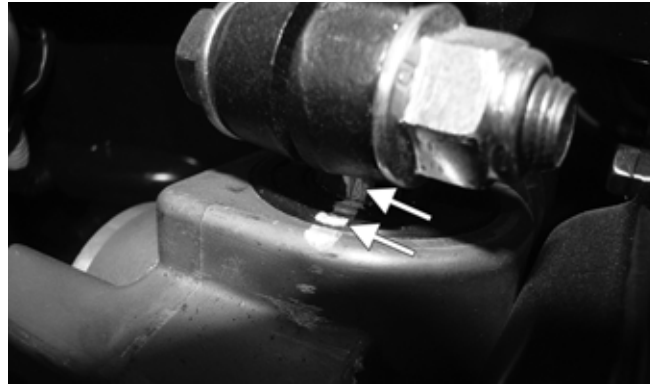

PR087A



MOD162

Mark the centerline of the front tires at the front and rear of the tire; then using a tape measure, measure and record the distance between the marks at the front and rear. The front measurement should be approximately 3-6 mm (1/8-1/4 in.) greater than the rear measurement (toe-out).



MOD066A

To adjust the wheel alignment, use the following procedure:

1. Using an open-end wrench to hold the tie rod ends (A), loosen the right-side and left-side jam nuts (B).

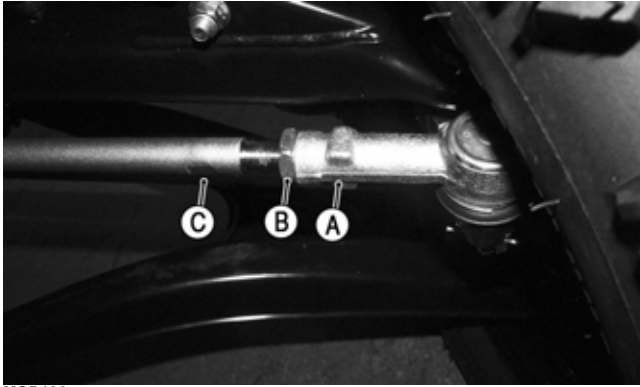

MOD196

CAUTION

Always use a wrench to hold the tie rod ends when loosening or tightening the jam nuts or damage to the boots could occur.

2. Turn the left-side and right-side tie rods (C) in equal increments to achieve the proper toe-out; then tighten the jam nuts securely.
3. Check steering for free operation (full-left/full-right).

Hood

REMOVING

1. Open the hood by turning the two 1/4-turn locks at the rear of the hood.

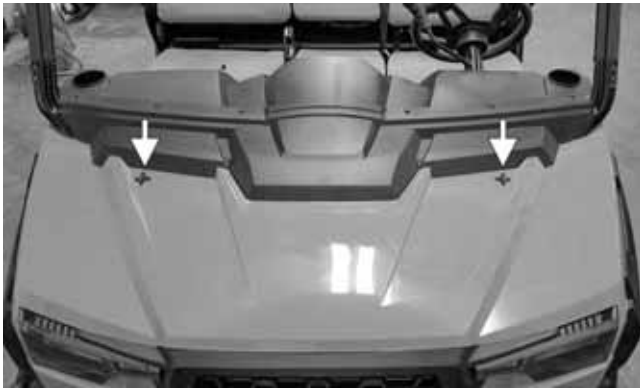

MOD008A

2. Remove the hood assembly.

CLEANING AND INSPECTING

1. Clean all hood components with soap and water.
2. Inspect the hood for cracks.
3. Inspect for any missing decals.

INSTALLING

Place the hood into position on the vehicle making sure the front tabs are in place; then secure the hood with the 1/4-turn locks.

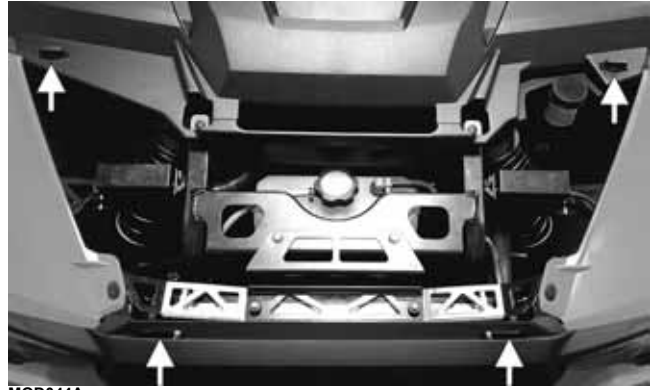

MOD044A

Upper Hood

REMOVING

1. Remove the hood; then remove the mid/upper dashboard; then the cap screws indicated



MOD044F

2. Remove the cap screws located next to each cup holder; then the cap screws in the middle; then remove mid/upper dash.



MOD251

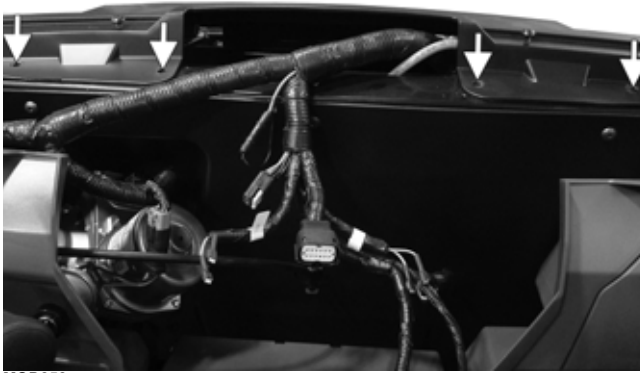

MOD252

Front Fascia/Grille

Grille (A)

Fascia (B)



MOD013A

REMOVING

1. Remove the hood; then the two T30 cap screws securing the grille and front fenders.

■NOTE: Take note of the higher shoulder and longer thread for fastening through multiple panels.



MOD044C

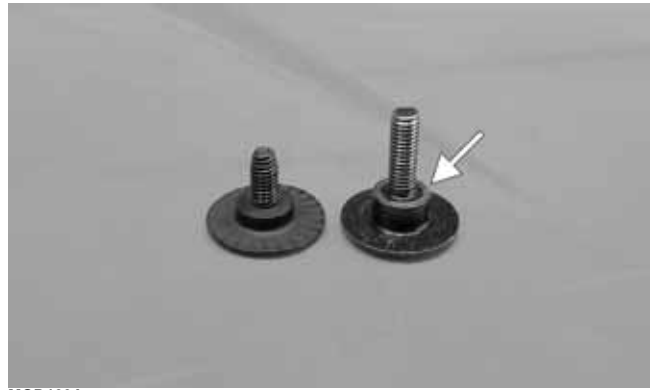

MOD133A

2. There are four cap screws per side that secure the bottom of the front fascia.
3. Remove the three T20 cap screws securing the outer front of the fascia; then remove them from the opposite side.



MOD134A

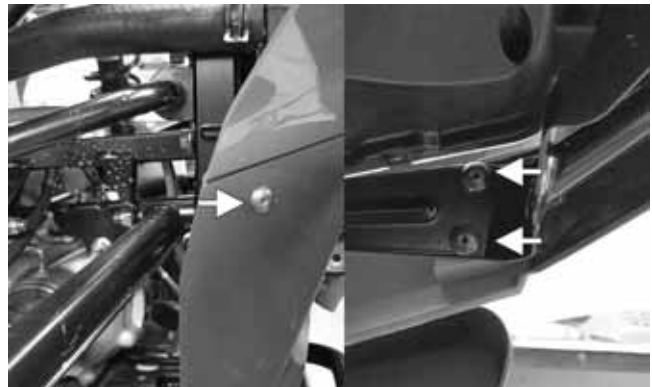

MOD140A

4. Remove the two T30 shouldered cap screws from the center of the front fascia; then remove the front fascia.

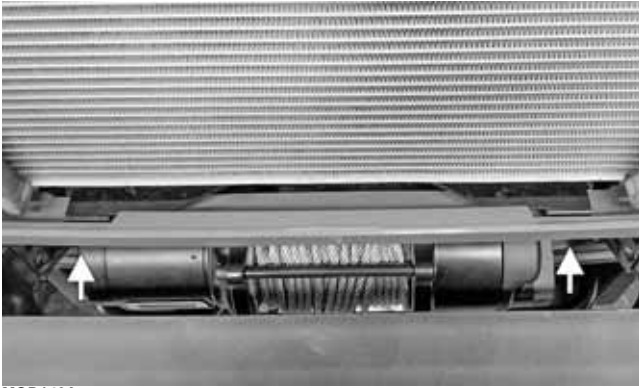

MOD140A

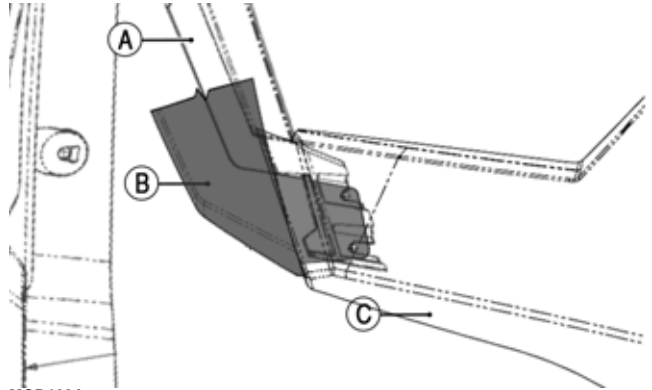

MOD138A



MOD136

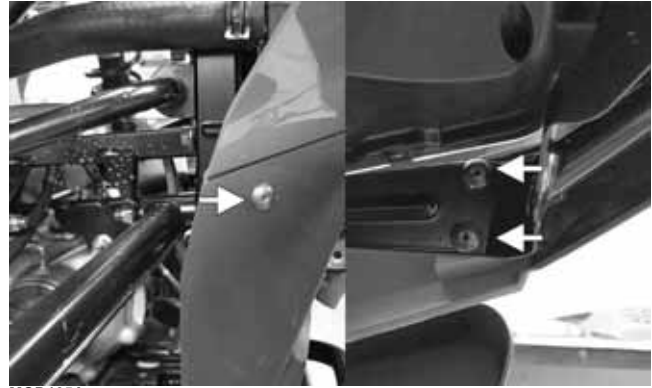

MOD135A

INSTALLING

1. Place the front fascia into position and secure the two T30 shouldered cap screws.

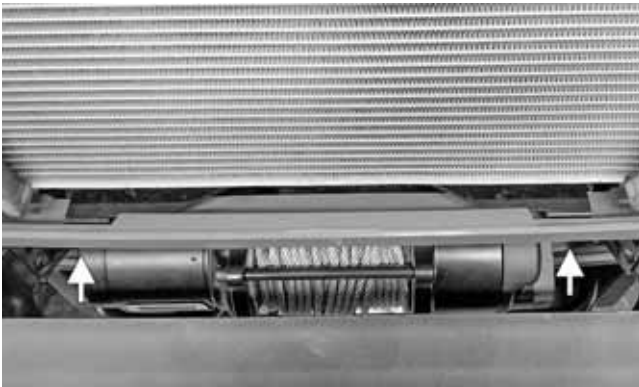

MOD140A



MOD044C

2. Install the two T20 cap screws through the (A) fender, (B) fender flare, and headlight bracket (not identified) into (C) front fascia/grille; then install the remaining T20 cap screw securing the front fascia to the lower grille. Repeat for opposite side.



MOD008A

5. Install the upper grille and tighten the two T30 cap screws; then install the hood and secure the 1/4-turn locks.

Lower Fascia

REMOVING

1. Remove the two cap screws located below the front tow hooks.

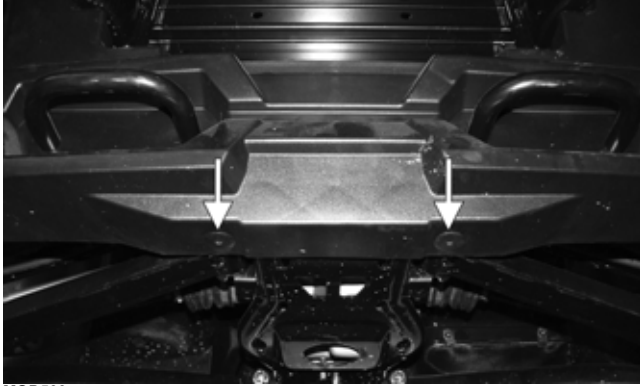

MOD509

2. Remove the two cap screws behind each tow hook and then remove the tow hooks.

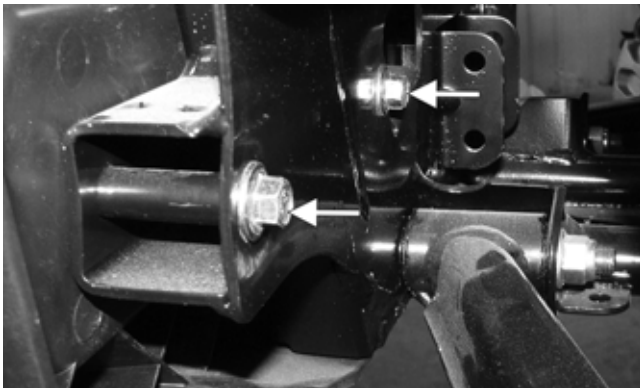

MOD510

3. Remove the lower fascia-to-grille cap screw on each side.

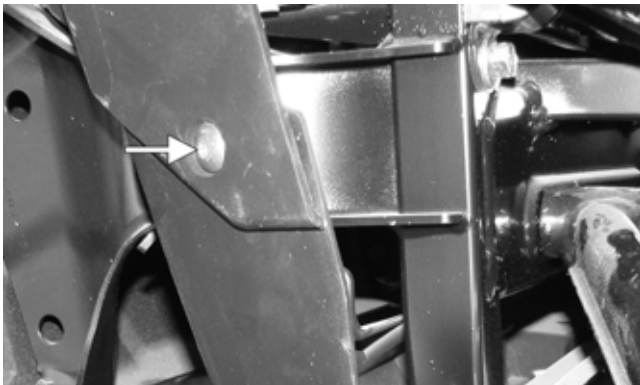

MOD511

INSTALLING

1. Position the lower fascia into place; then install the lower fascia to grille cap screw on each side.

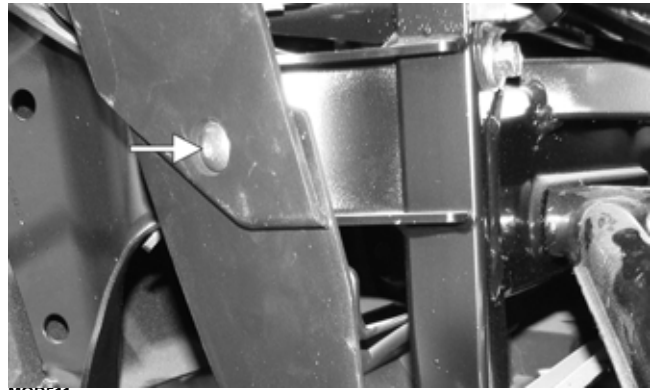

MOD511

2. Position the tow hooks into place; then install the two cap screws behind each tow hook. Tighten to 20 ft-lb (27.2 N-m).

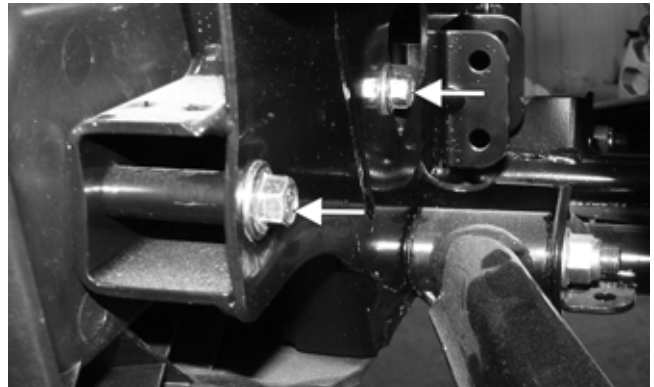

MOD510

3. Install the two cap screws located below the front tow hooks.

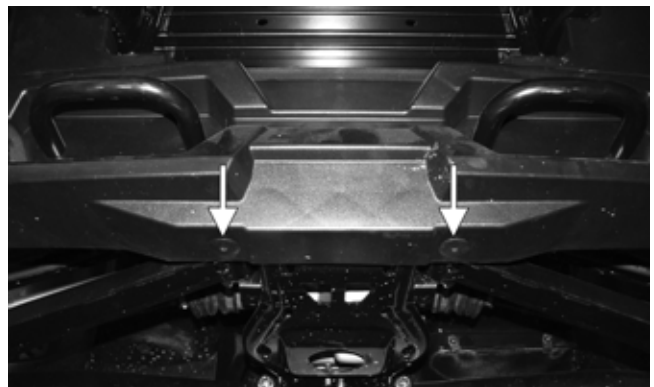

MOD509

Front Fenders/Fender Flares

Removing the fender is recommended to remove the fender flare

REMOVING

1. Remove the hood, upper hood and mid/upper dashboard. Located in the front of the inner fender, remove the two cap screws securing the fender, fender flare and grille to the headlight bracket.



MODC056

2. Remove the three shouldered cap screws from the top of the side cover and the two shouldered cap screws from the bottom of the side cover.

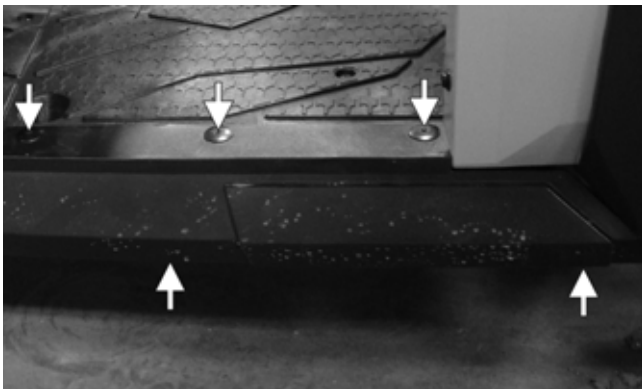

MOD262

3. Gently pull on the front portion of the side panel; then remove the cap screw securing the fender to the frame.

■NOTE: A 1/4-in. driver bit is recommended to access this cap screw. More side panel cap screws will need to be removed to make room for a larger tool.



MOD142

4. Remove the four cap screws from the inner fender.



MOD137A

5. Remove the three cap screws indicated.

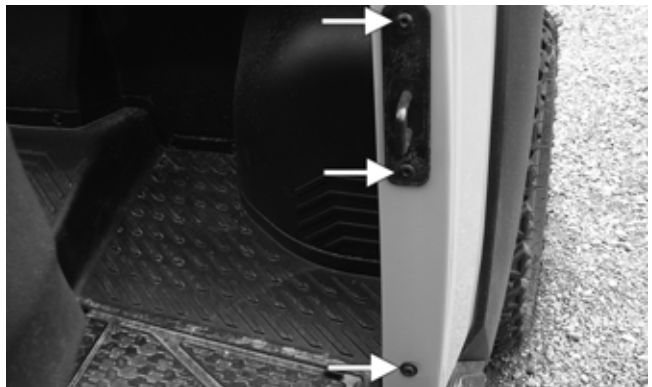

MOD592

6. Remove the two remaining cap screws on the top portion of the fender; then remove fender. If fender flare removal is desired, continue to step 7.



MOD150A



MOD607

7. With the fender removed from the vehicle, remove the four cap screws on the inside of the fender; then remove the fender flare from fender taking note of the four tabs on the fender flare.



MODC065A



MODC065

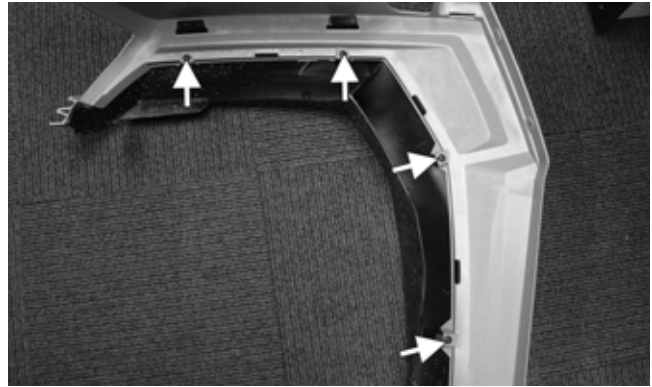

MODC065

2. Place the fender into position; then install the two cap screws on the top portion of the fender.



MODC065A



MOD150A

INSTALLING

If installing fender flare, start at step 1. If installing fender, start at step 2.

1. With the fender removed from the vehicle, install the fender flare onto the fender taking note of the four tabs on the fender flare; then install the four cap screws to secure fender flare to fender.



MOD607

3. Install the three cap screws indicated.

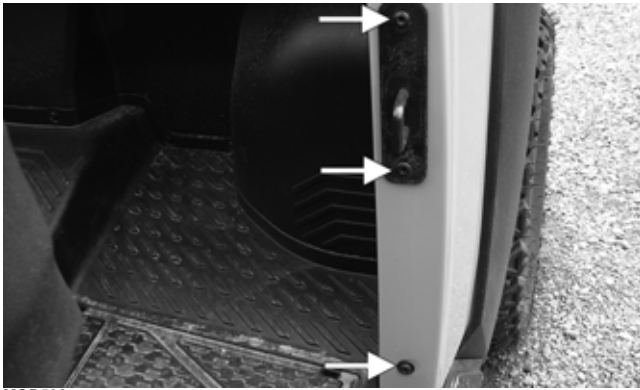

MOD592

4. Install the four cap screws in the inner fender.

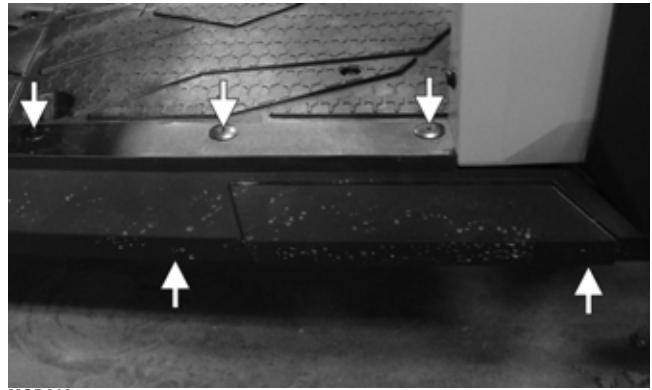

MOD262

7. Located in the front of the inner fender, install the two cap screws securing the fender, fender flare and grille to the headlight bracket. Install the upper hood, mid/upper dashboard and hood; then adjust doors as needed.



MOD137A

5. Gently pull on the front portion of the side panel; then install the cap screw securing the fender to the frame.

■NOTE: A 1/4-in. driver bit is recommended to access this cap screw. More side panel cap screws will need to be removed to make room for a larger tool.



MODC056



MOD142

6. Install the three shouldered cap screws from the top of the side cover and the two shouldered cap screws from the bottom of the side cover.

Side Panels

FRONT REMOVING

1. Remove the four cap screws indicated behind the front row of seats.

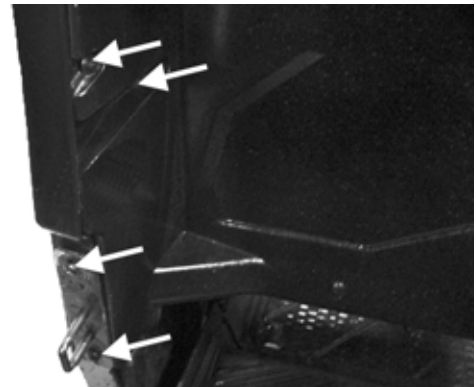

MOD631

2. Remove the cap screw behind the upper seat backrest; then remove the cap screw behind the lower seat backrest.

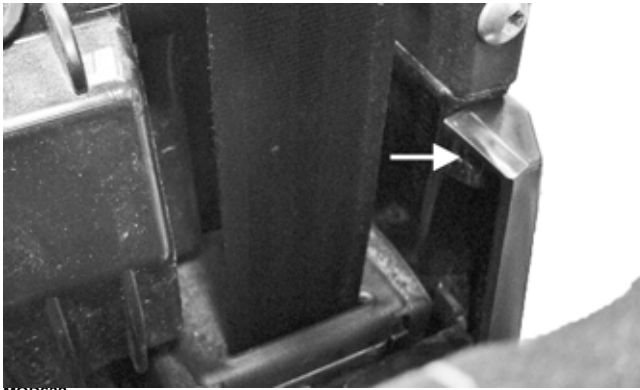

MOD632

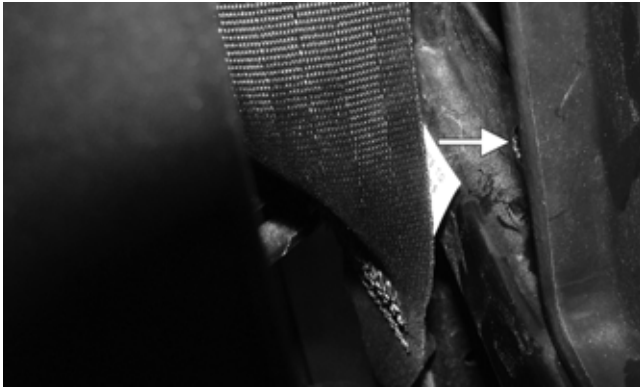

MOD651

3. Remove the three cap screws underneath the vehicle; then open the rear door and remove the cap screw underneath the rear door.

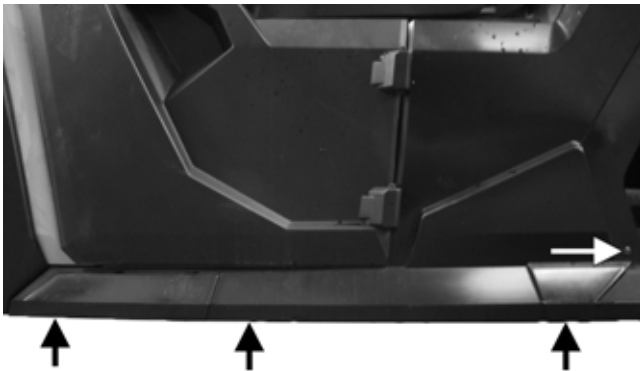

MOD648

4. Open the front door; then remove the four cap screws securing the door; then remove the front door.

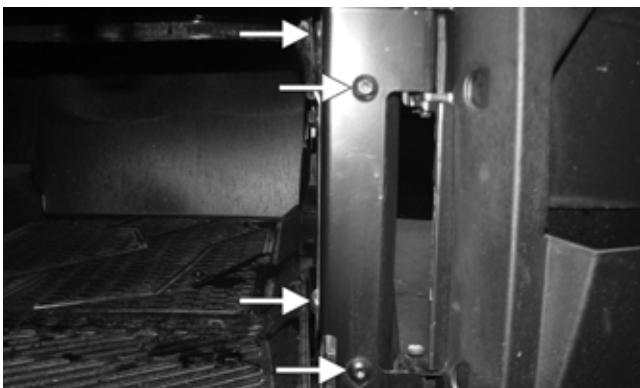

MOD649

5. Remove the cap screw near the center ROPS-to-chassis connection.



MOD652

6. Remove the three cap screws securing the side panel to the floor; then gently remove side panel.

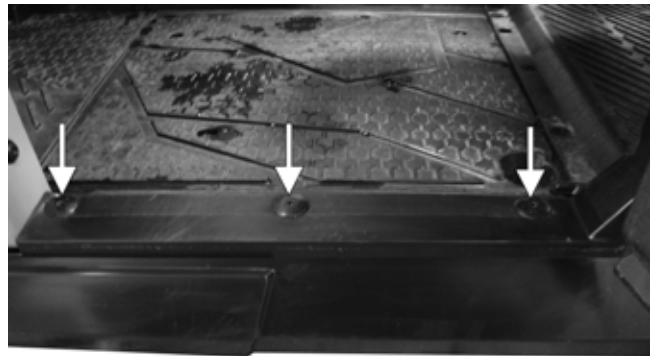

MOD650

FRONT INSTALLING

1. Position the side panel into place; then install the three cap screws securing the side panel to the floor.

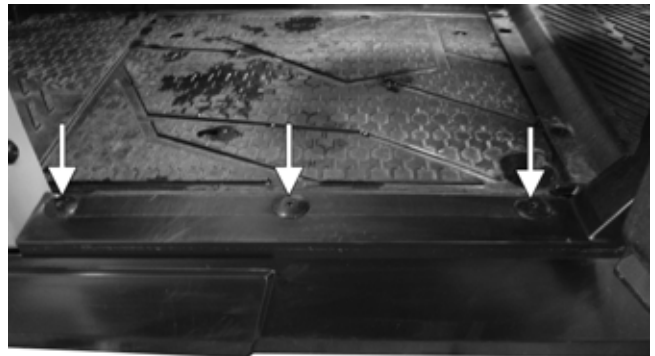

MOD650

2. Install the cap screw near the center ROPS-to-chassis connection.



MOD652

3. Position the front door into position; then install the four cap screws securing the door.

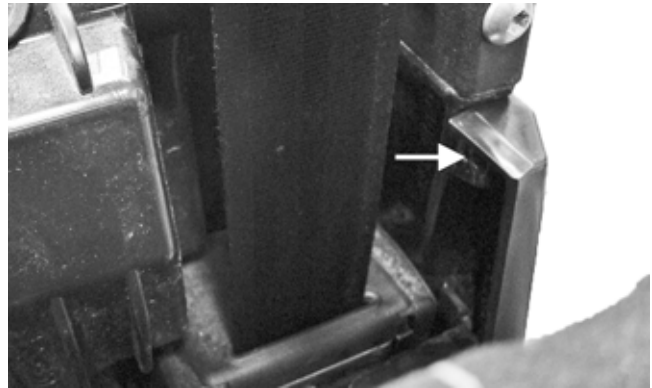

MOD632

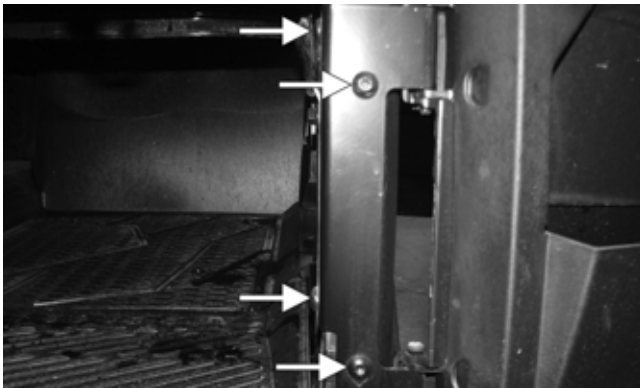

MOD649

4. Install the three cap screws underneath the vehicle; then open the rear door and install the cap screw underneath the rear door.

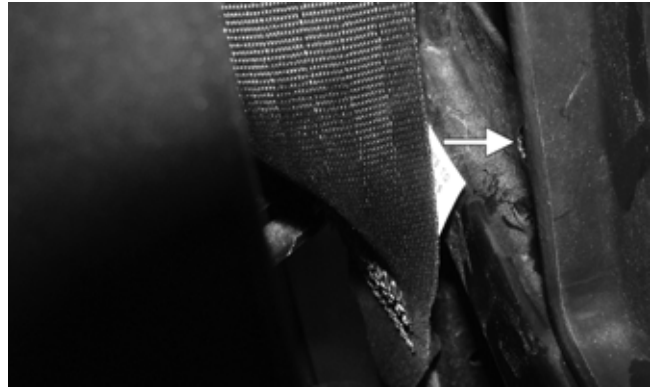

MOD651

6. Install the four cap screws indicated behind the front row of seats; then adjust the door as needed.

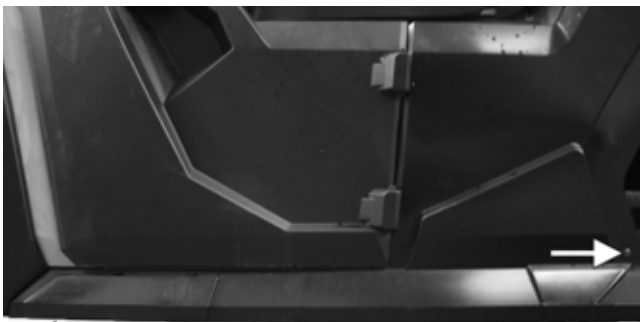

MOD648

5. Install the cap screw behind the upper seat backrest; then install the cap screw behind the lower seat backrest.

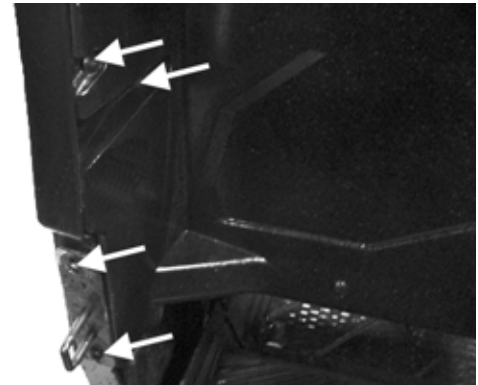

MOD631

REAR REMOVING

1. Tilt the cargo box into the up position; then remove the rear inner fender; then remove the cap screws behind the rear ROPS mounting point.

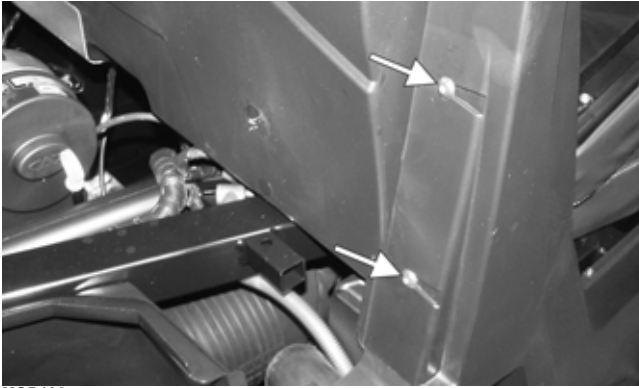

MOD190

2. Remove the three cap screws from inside the behind-the-seat storage box panel.

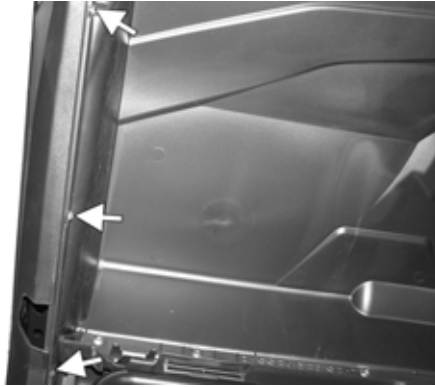

MOD191

3. Remove the three cap screws securing the side panel to the floor; then remove the four cap screws underneath the side panel.

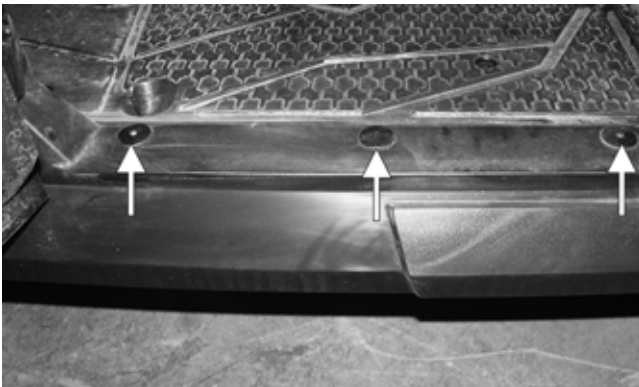

MOD653

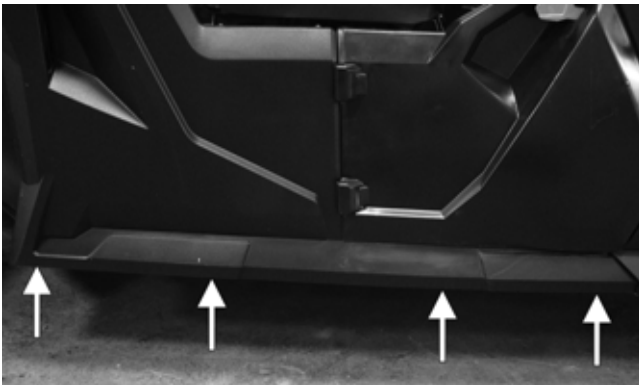

MOD654

4. Remove the four cap screws securing the door hinge and remove the door hinge; then remove the remaining cap screws securing the side panel; then remove the side panel.

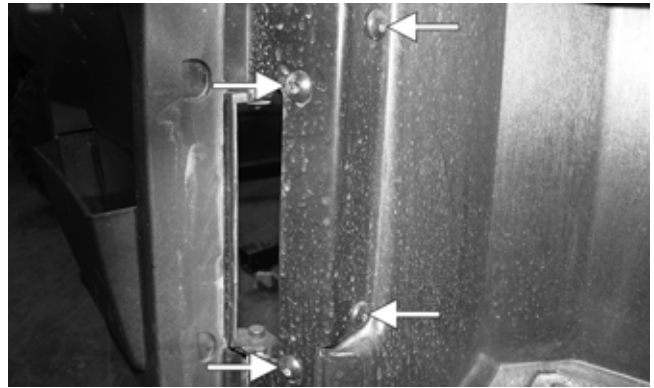

MOD595

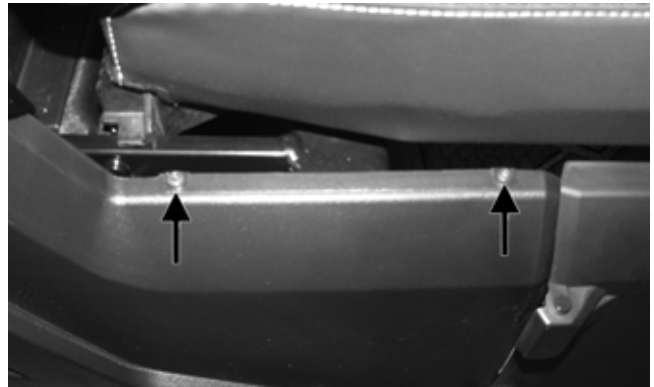

MOD192

REAR

INSTALLING

1. Position the cargo box into the up position; then reinstall the cap screws behind the rear ROPS mounting point.

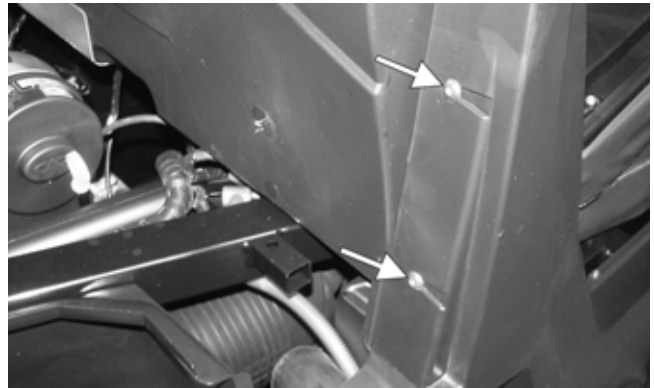

MOD190

2. Reinstall the three cap screws from inside the behind-the-seat storage box panel.

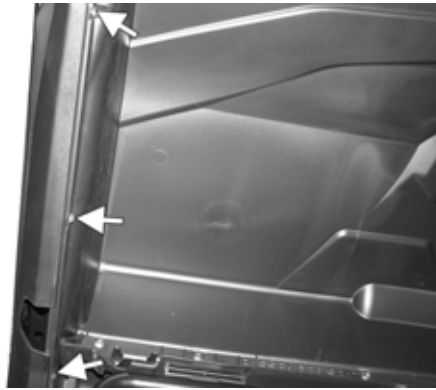

MOD191

3. Position the door hinge into place; then reinstall the four cap screws securing the door hinge; then reinstall the remaining cap screws securing the side panel; then reinstall the rear inner fender.

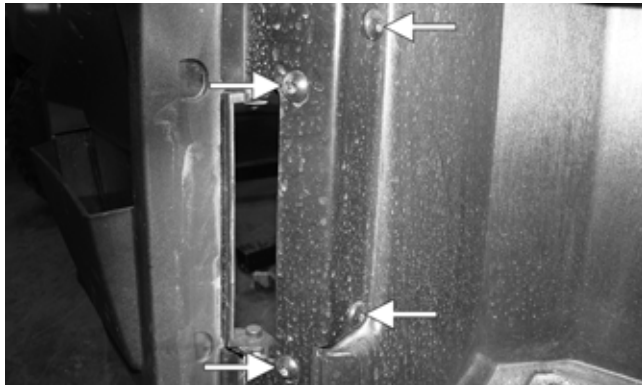

MOD595

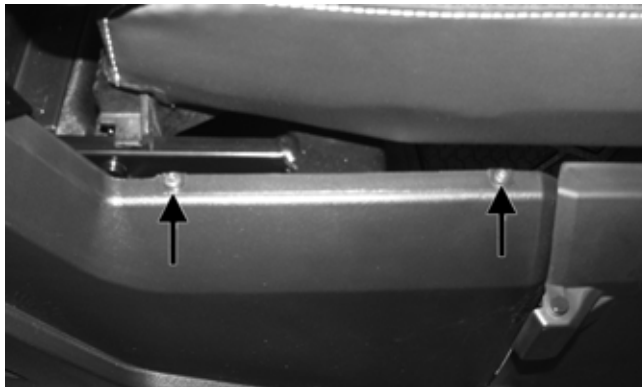

MOD192

4. Install the three cap screws securing the side panel to the floor; then install the four cap screws underneath the side panel.

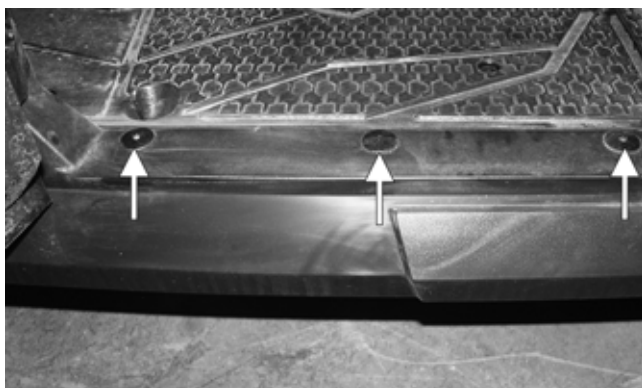

MOD653

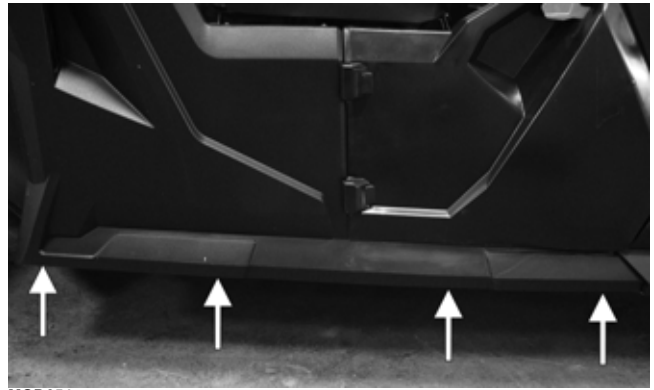

MOD654

Doors

ADJUSTING DOORS

1. Door adjustment is accomplished by loosening the striker plate cap screws; then moving the striker plate up, down, in or out on the slotted holes. When desired latching/unlatching is obtained, tighten cap screws.



MOD279

Roof (Optional)

REMOVING/INSTALLING

1. Remove the cap screws and lock nuts securing the clamps at the rear of the roof. Account for the washers and the lock nuts. Discard lock nuts. Inspect cap screws and replace if damaged.

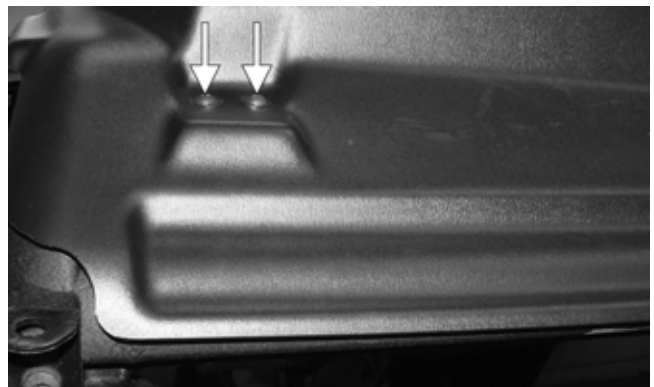

MOD689

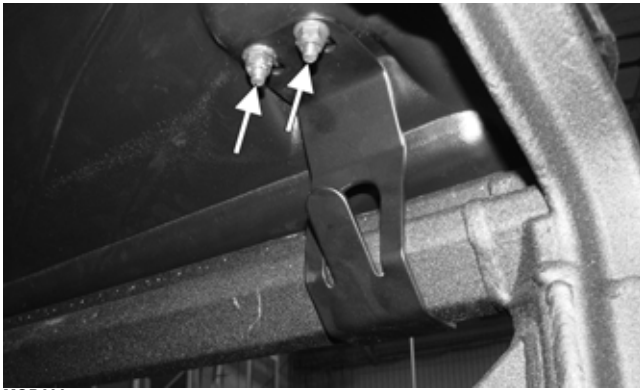

MOD690

2. Remove the cap screws and lock nuts at the front of the roof. Account for the washers and the lock nuts. Remove the roof.

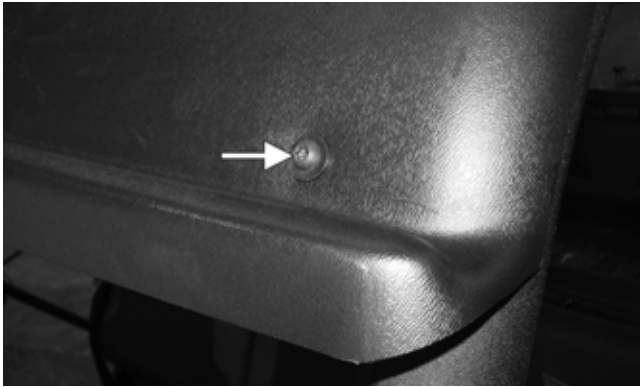

MOD691

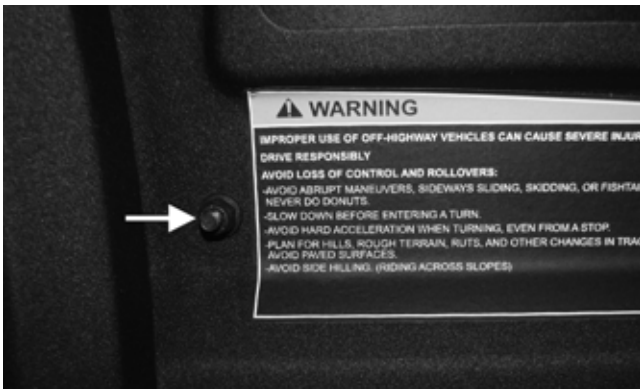

MOD692

3. Position roof onto the ROPS of the vehicle; then hook the rear brackets under the rear ROPS tube; then loosely secure the four rear brackets to the rear of the hardtop using eight cap screws, eight washers, and eight lock nuts. The washers should be on the top of the roof. Finger tighten only at this time.
4. Loosely secure the front of the hardtop to the ROPS using four cap screws, four washers, and four lock nuts. The washers should be on the outside of the roof.
5. Tighten all hardware securely.

Front Bumper (Optional)

REMOVING/INSTALLING

1. Remove the two cap screws and lock nuts per side on the lower portion of the front bumper. Note the location of the spacers. Discard lock nuts. Inspect cap screws and replace if damaged.

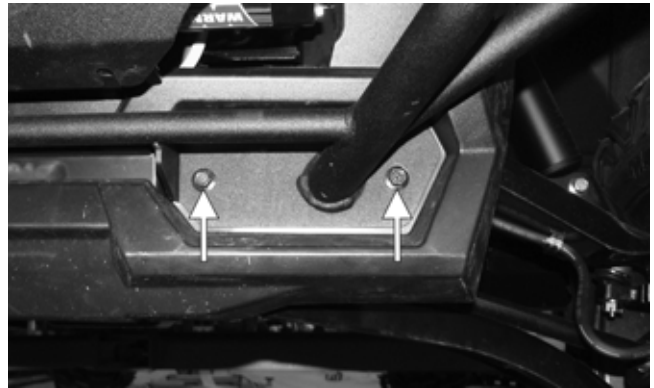

MOD686

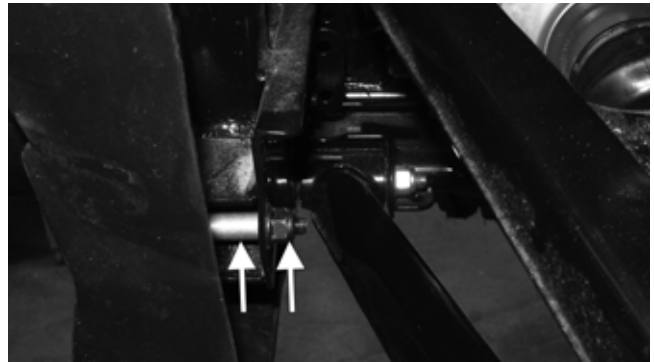

MOD687

2. Remove the hook on the winch cable. Remove the two cap screws securing the winch fairlead; then remove the winch fairlead; then remove the four outer cap screws securing the bumper to the frame; then remove the bumper from the vehicle.

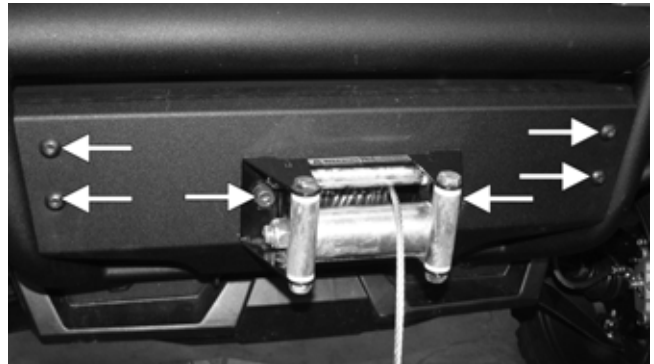

MOD688

3. Position the bumper into place; then install the four outer cap screws securing the bumper to the frame; then position the winch fairlead into place with the cable through the fairlead; then install the two cap screws securing the winch fairlead; then install the hook to the winch cable. Finger tighten only at this time.
4. Install the two cap screws, spacers and lock nuts per side on the lower portion of the front bumper. Tighten all fasteners securely.

Rear Bumper (Optional)

REMOVING/INSTALLING

1. Remove the four cap screws and lock nuts; then remove bumper. Discard lock nuts. Inspect cap screws and replace if damaged.



MOD684

2. Remove the four cap screws and two lock nuts per bumper bracket; then discard lock nuts; then remove bumper brackets.

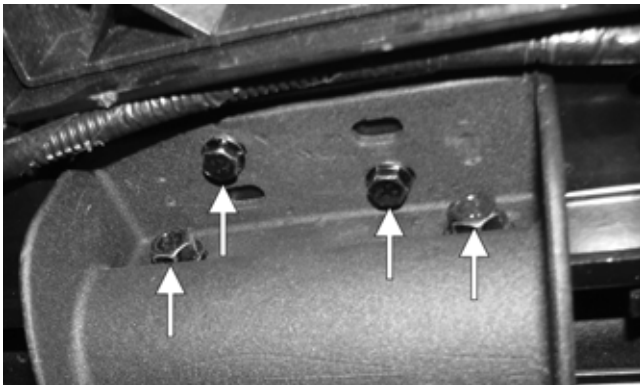

MOD685

3. Install the four cap screws and two new lock nuts per bumper bracket. Finger tighten only at this time.
4. Position the bumper into place; then install the four cap screws and new lock nuts; then tighten all hardware securely.

Floor

The floor consists of three different sections (front, center and rear). The center and rear sections can be removed independently. To remove the front section, first remove the center section.

■NOTE: For efficiency, it is preferable to remove and disassemble only those components which need to be addressed and to service only those components. The technician should use discretion and sound judgment.

■NOTE: For removal of the gas tank, only the rear section is required to be removed. For removal of the hanger bearing, only the center section is required to be removed.

FRONT REMOVING

1. Remove the front seats, front side panels, and center floor.
2. Remove the three fasteners securing the splash panel on each side.

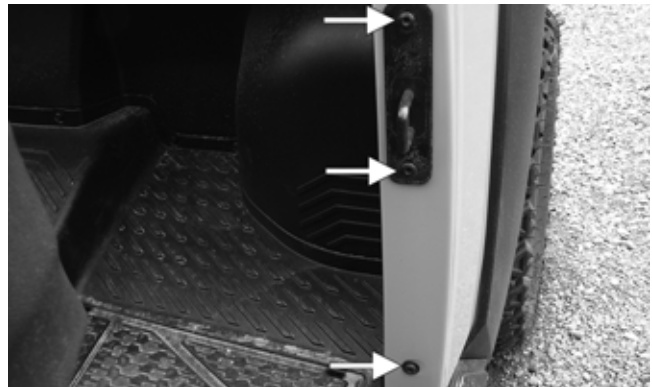

MOD592

3. Remove the six fasteners on the occupant side securing the splash panel to the floor.

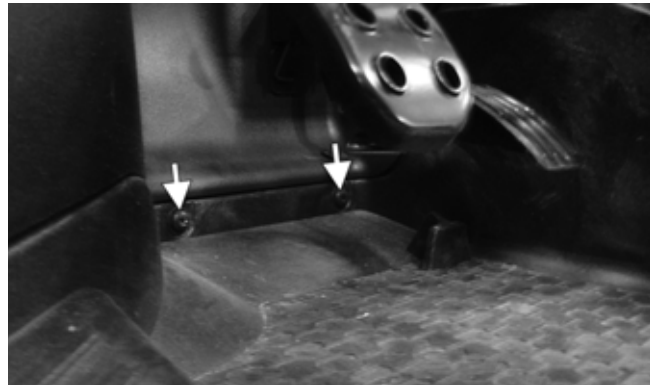

MOD287

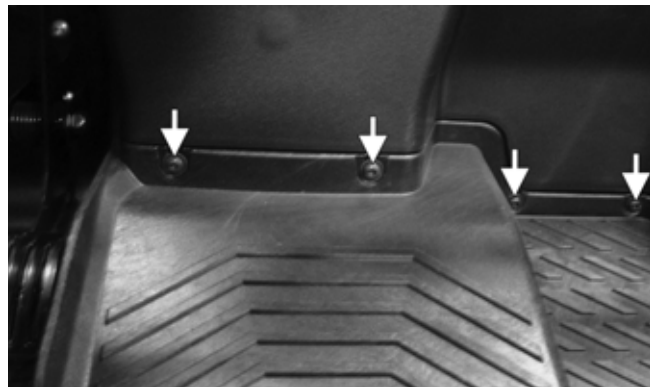

MOD288

4. Remove the two cap screws located near the front tires securing the splash panel to the floor on each side.



MOD289A

5. Remove the five cap screws securing the floor to frame.

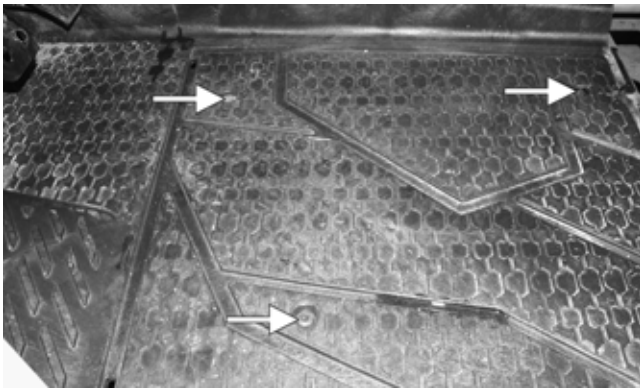

MOD656

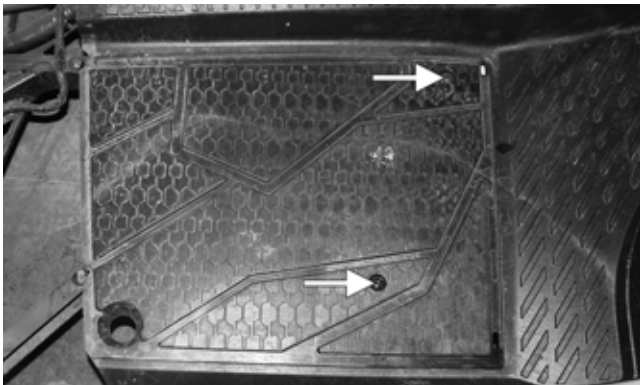

MOD655

6. Gently lift the rear of the floor up and lift the floor out of the vehicle.

CENTER

REMOVING

1. Remove the front seats and front side panels.
2. Remove the 12 cap screws securing the center floor to the frame.

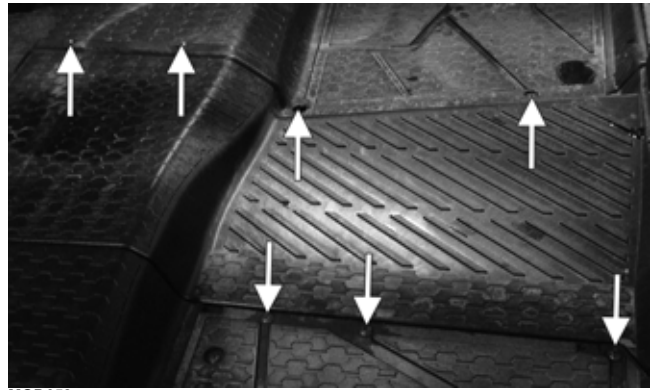

MOD658

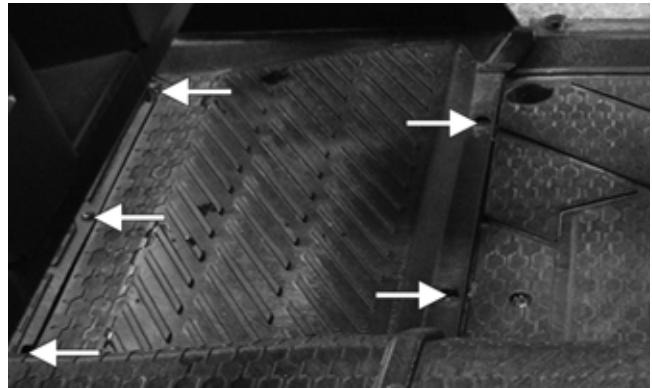

MOD657

3. Gently lift the front portion of the center floor up and remove from vehicle.

REAR

REMOVING

1. Remove the rear seats, behind-the-seat storage box panel, rear side panels, and rear seat base.
2. Remove the cap screw located near the rearmost corner of the floor on each side.



MOD290

3. Remove the 13 cap screws securing the rear floor to the frame.

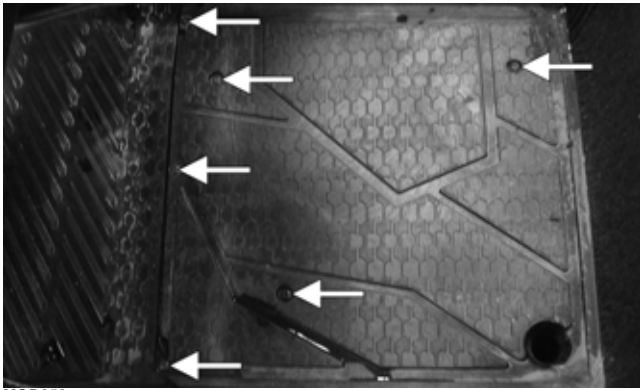

MOD659

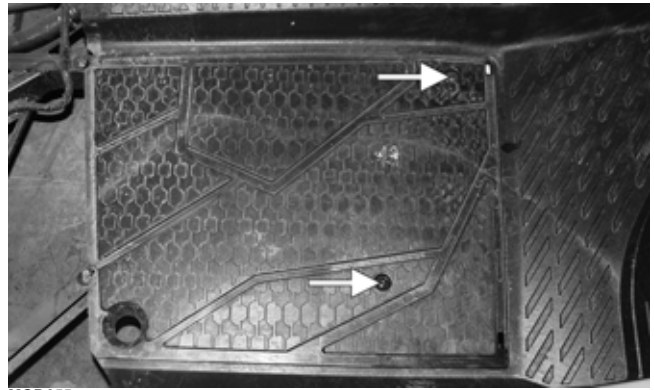

MOD655

2. Install the two cap screws located near the front tires securing the splash panel to the floor on each side.

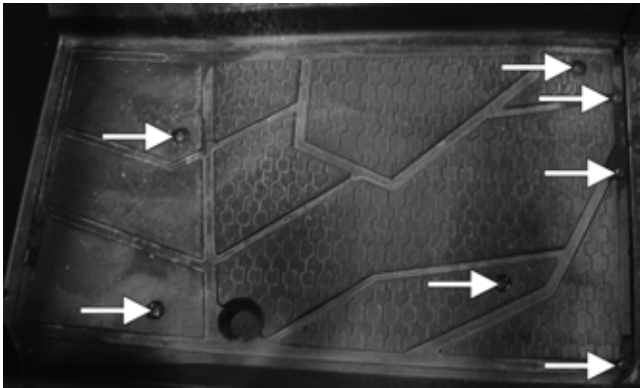

MOD660

4. Gently lift the front portion of the rear floor up and remove from vehicle.

CLEANING AND INSPECTING

1. Clean the floor with soap and water.
2. Inspect the floor for cracks or holes.

FRONT

INSTALLING

1. Place the front of the floor into position in the vehicle first; then lower the rear; then fasten the six cap screws securing the floor to frame.

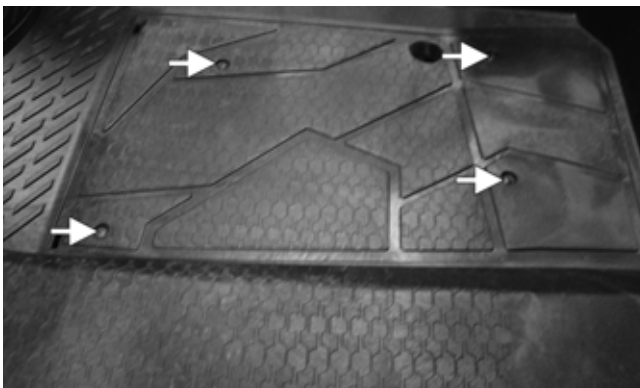

MOD656



MOD289A

3. Install the six fasteners on the occupant side securing the splash panel to floor.

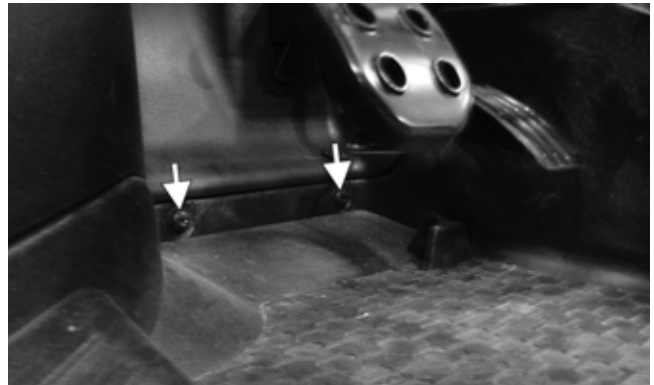

MOD287

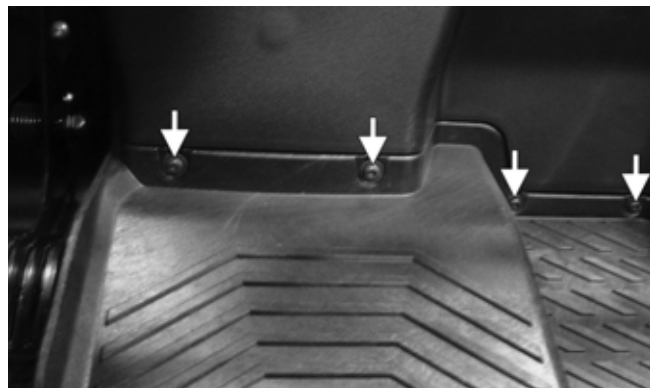

MOD288

4. Install the three fasteners securing the splash panel on each side.

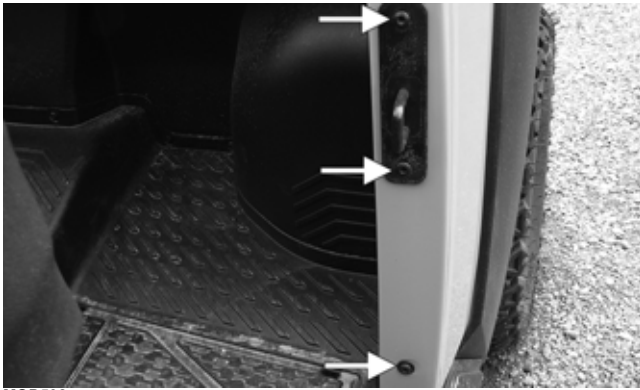

MOD592

5. Install the front seats, front side panels, and center floor section. Adjust doors as needed.

CENTER INSTALLING

1. Position the floor into the vehicle and gently position the rear portion of the center floor down and underneath the rear floor section.
2. Install the 12 cap screws securing the center floor to the frame.

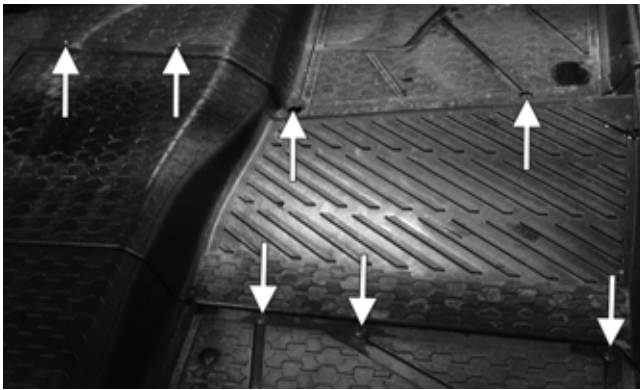

MOD658

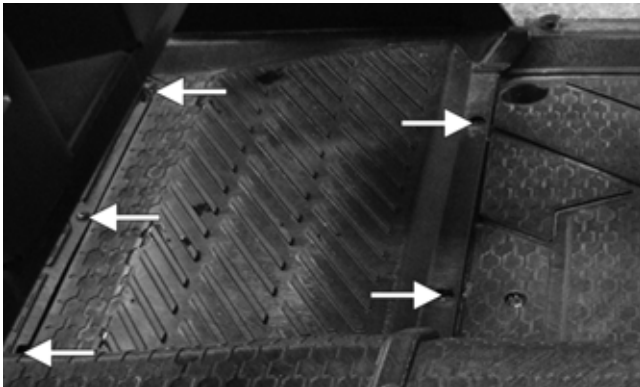

MOD657

3. Install the front seats and front side panels.

REAR INSTALLING

1. Position the floor into the vehicle.
2. Install the cap screw located near the rearmost corners of the floor on each side.

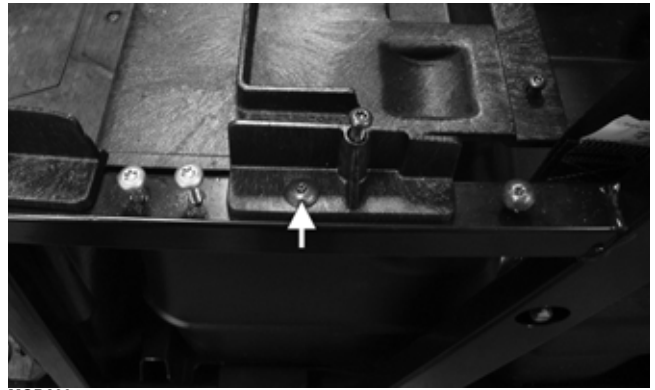

MOD290

3. Install the 13 cap screws securing the rear floor to the frame.

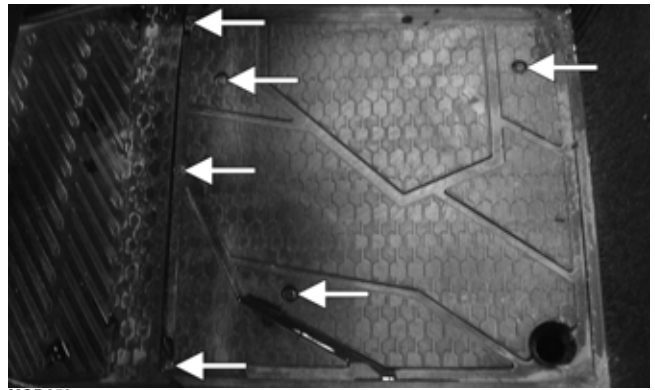

MOD659

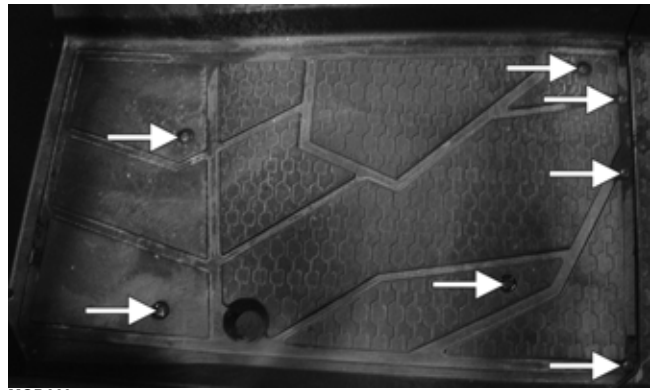

MOD660

4. Install the rear seat base, behind-the-seat storage box panel, rear side panels, and rear seats.

Dashboard (Mid/Upper)

REMOVING

1. Disconnect the battery; then remove the cap screws indicated, taking note of the different fastener types in the different locations.

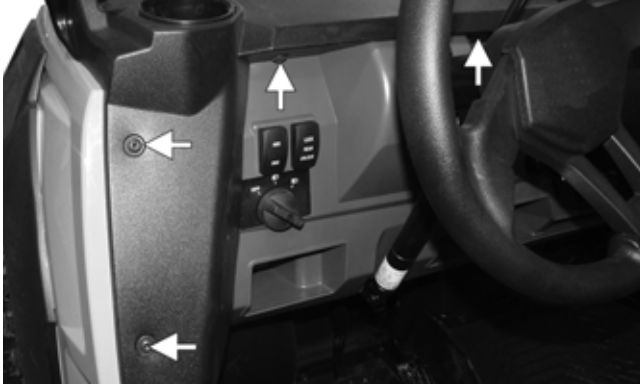

MODC059A

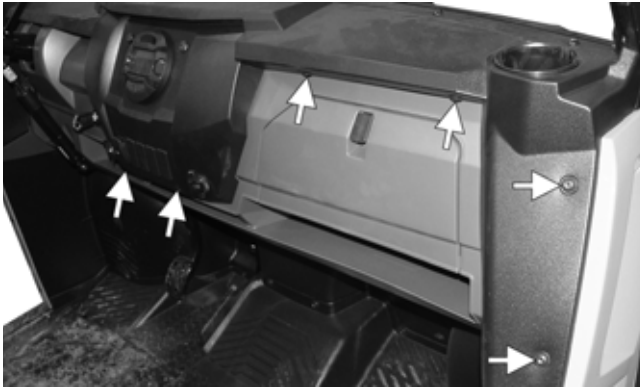

MODC060

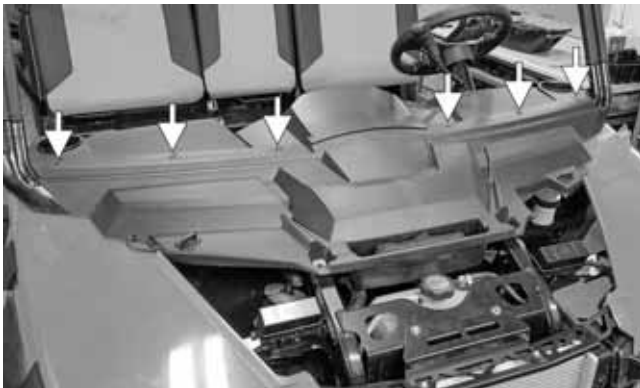

MOD146B

3. Gently lift the mid/upper dashboard above the cup holders on each side. Take note of the tabs on each side that must be lifted vertically at an angle.



MODC061

4. From behind the dashboard, disconnect the LCD gauge (A), and DC power outlets (B)(C). Note the orientation of the connectors for installing purposes; then remove the mid/upper dashboard.

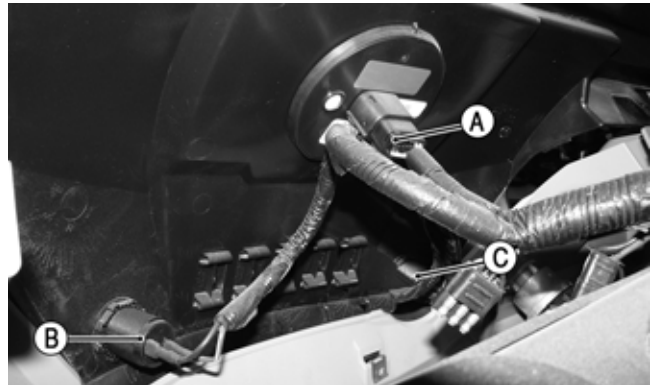

MOD594A

INSTALLING

1. From behind the dashboard, connect the LCD gauge (A), and DC power outlets (B)(C).

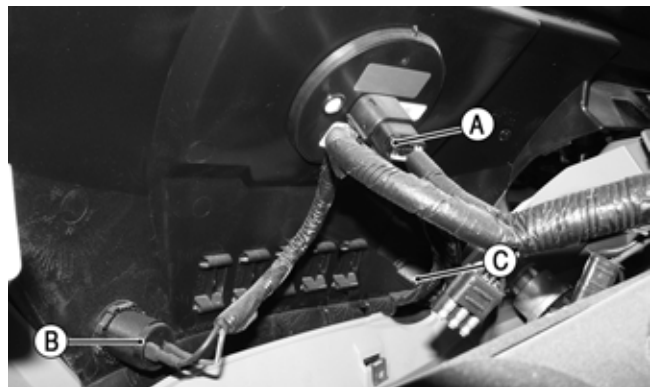

MOD594A

2. Gently position the dashboard, taking note of the tabs on each side that must be positioned at an angle; then place dashboard over cup holders.

Dashboard (Lower)

REMOVING

1. Remove the mid/upper dashboard; then remove the three cap screws on each fender.



MODC061A

3. Install the cap screws indicated, taking note of the different fastener types in the different locations; then connect the battery.

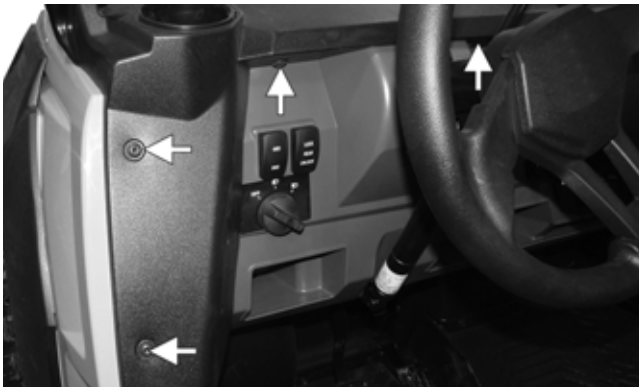

MODC059

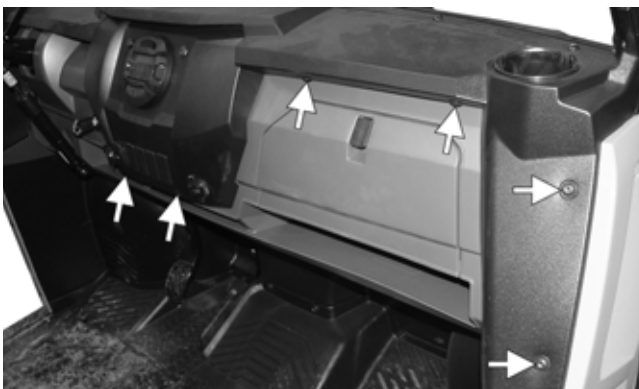

MODC060

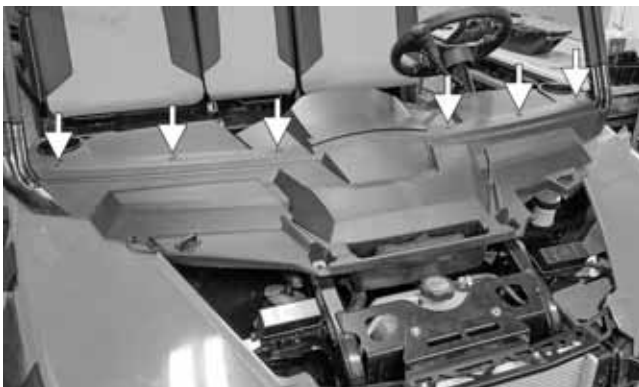

MOD146B

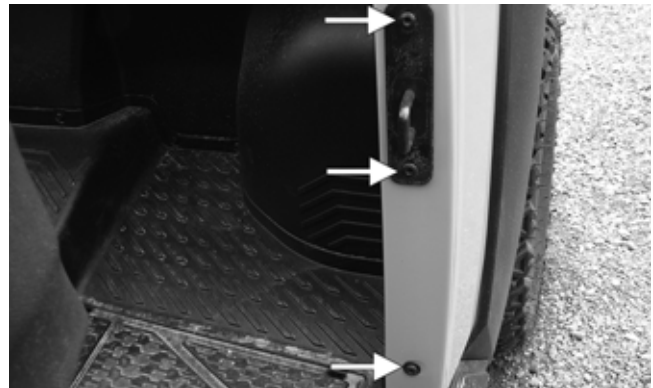

MOD592

CAUTION

When removing the lower steering adjuster mount, the steering wheel tilt assembly will be unsecured and could drop causing injury. Hold the steering wheel tilt assembly while removing the lower steering adjuster cap screw to prevent this.

2. Remove the lower steering adjuster cap screw. With a suitable strap secure the steering wheel tilt assembly up and out of the way.



MOD263



MOD264A

3. Remove the key switch locking nut by turning counterclockwise; then push the key switch through hole to clear the lower dashboard; then disconnect the electrical connectors on the left side of the dashboard.

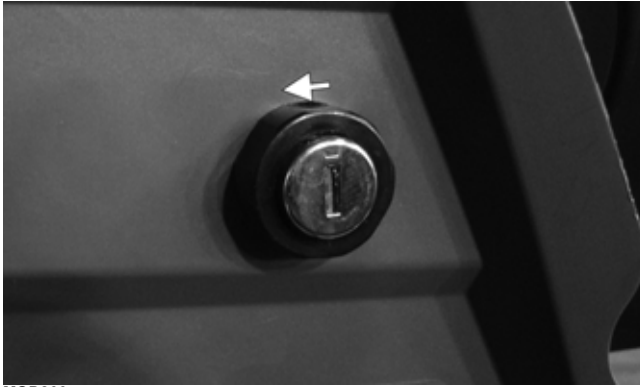

MOD266



MOD265

4. Remove the five cap screws along the bottom of the lower dashboard; then remove the lower dashboard taking note of the tabs on each side of the lower dashboard.

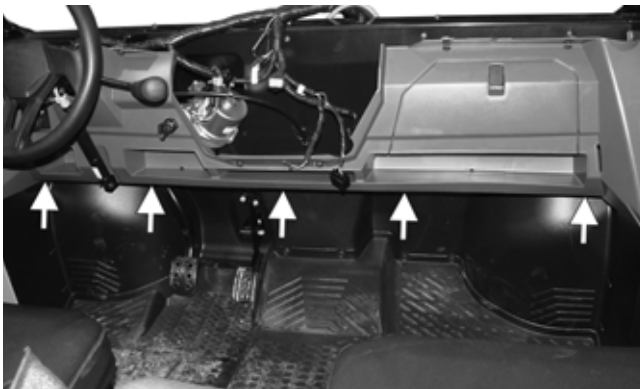

MOD268A

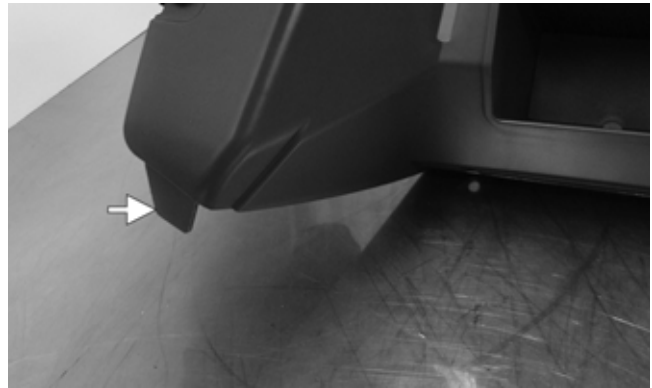

MOD267

INSTALLING

1. Position the lower dashboard into place taking note of the tabs on each side of the lower dashboard. Install the five cap screws along the bottom of the lower dashboard.

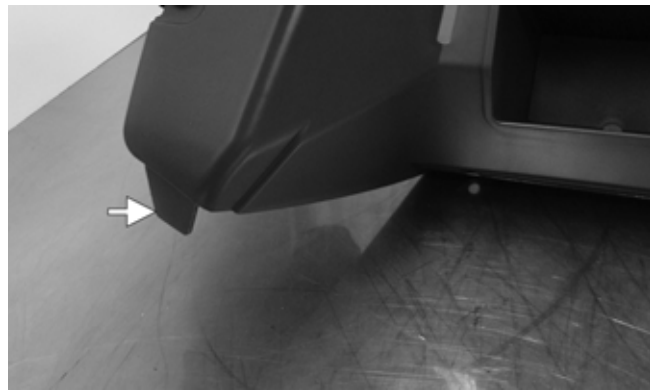

MOD267

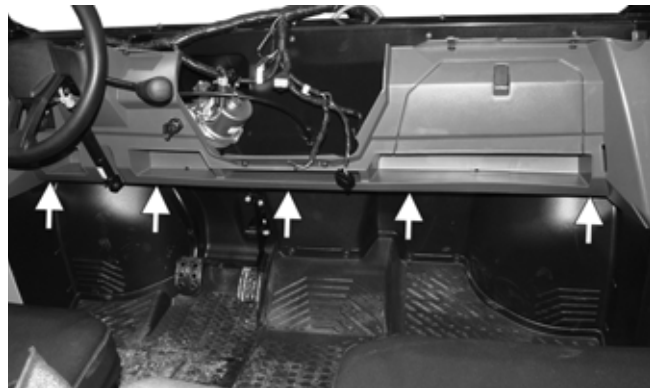

MOD268A

2. Reinstall the key switch into the key switch cut out; then secure by turning the locking nut clockwise; then reconnect the electrical connectors on the left side of the dash.

■ **NOTE:** The 4WD/2WD switch should be installed in the outermost switch slot on the left side of the dash and plugged into the connector that has white/green, black, and orange/gray wires. The LOCK/UNLOCK switch should be installed in the innermost switch slot on the left side of the dash and plugged into the connector that has yellow/orange, black, and orange/gray wires.



MOD266A



MOD265

3. Remove the suitable strap securing the steering wheel tilt assembly out of the way; then reinstall the lower steering adjuster cap screw. Tighten to 6 ft-lb (8.2 N-m).



MOD264A



MOD263

4. Reinstall the three cap screws on each fender; then install the mid/upper dashboard; then adjust doors as needed.

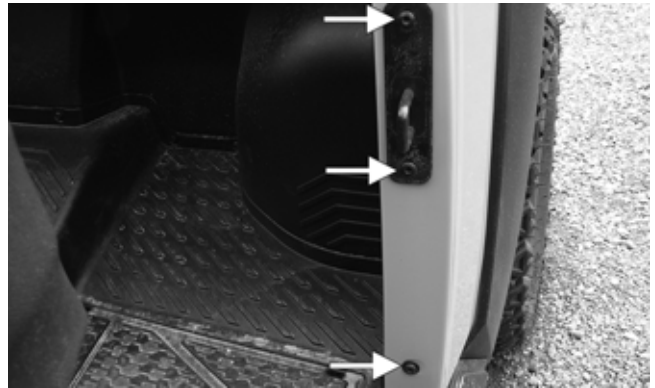

MOD592

Splash Panel

REMOVING

1. Remove the mid/upper dashboard, lower dashboard, side panels, seats, seat base, EPS, lower steering adjuster cap screw, and floor.
2. Disconnect the master brake cylinder, throttle cable, and shift cable.
3. Remove the five cap screws along the top of the splash panel; then remove the splash panel from the bottom.

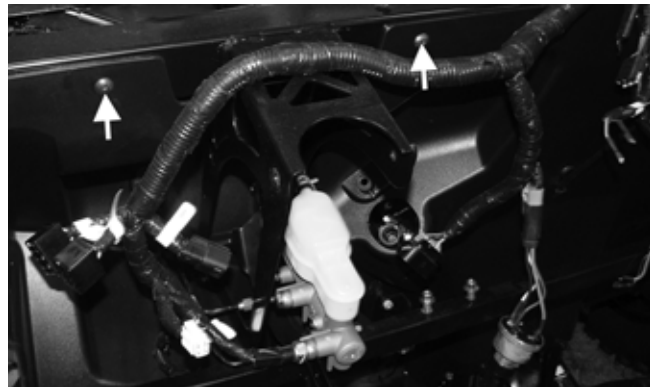

MOD311



MOD312

INSTALLING

1. Position the splash panel into place; then install the five cap screws along the top of the splash panel.

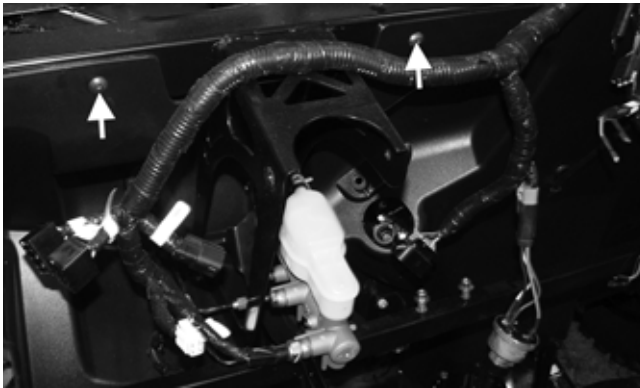

MOD311



MOD312

2. Connect the master brake cylinder, throttle cable, and shift cable
3. Install the floor, lower steering adjuster cap screw, EPS, seat base, seats, side panels, lower dashboard, and mid/upper dashboard.

Skid Plates

REMOVING

1. Remove the body screws securing the skid plates to the underside of the frame.
2. Remove the skid plates.

INSTALLING

1. Place the skid plates into position on the underside of the frame.
 2. Install the body screws. Tighten to 6 ft-lb (8.2 N-m).
-
-

Muffler

REMOVING

1. Remove the three cap screws and nuts at the muffler/exhaust pipe juncture. Discard lock nuts. Inspect cap screws and replace if damaged.

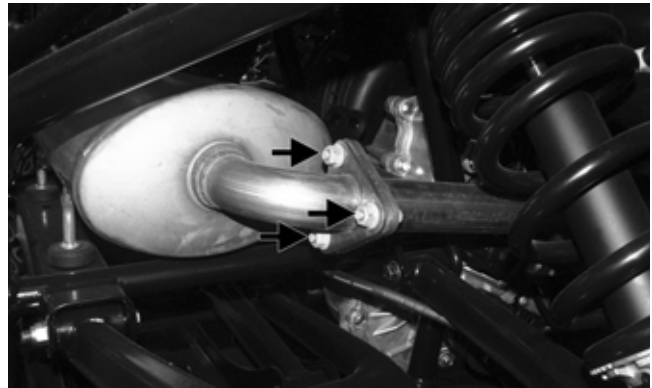

MOD231

2. Lift the muffler assembly upward to clear the three holders underneath the muffler assembly.

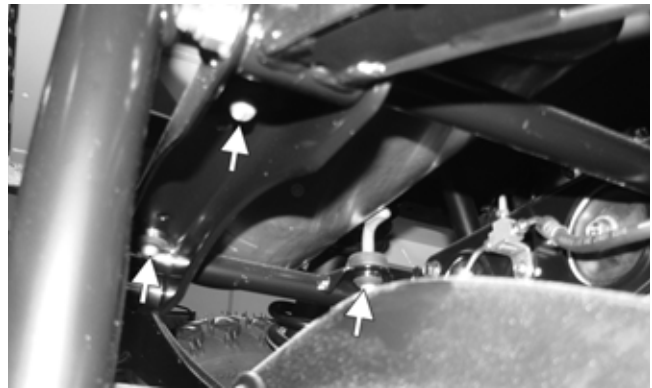

MOD232

INSPECTING

1. Inspect muffler externally for cracks, holes, and dents.
2. Inspect the muffler internally by shaking the muffler back and forth and listening for rattles or loose debris inside the muffler.

■ **NOTE:** For additional details on cleaning the muffler/spark arrester, see *Periodic Maintenance/Tune-Up*.

INSTALLING

1. Place the muffler onto the three holders and push into position.
 2. With a new gasket installed, secure the muffler to the exhaust pipe with the three cap screws and with new lock nuts. Tighten to 16 ft-lb (21.8 N-m).
-
-

Cargo Box

REMOVING

1. Raise the cargo box; then disconnect the electrical connection near the passenger side cargo box pivot point.

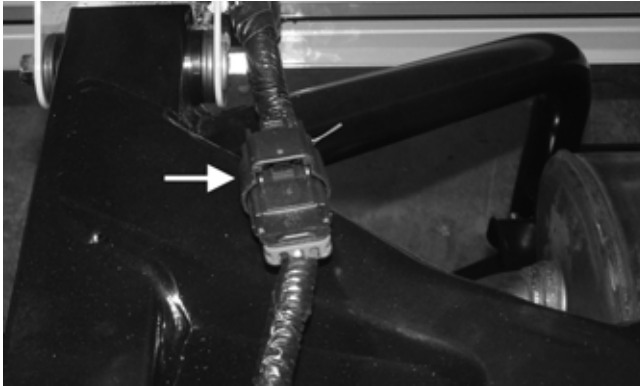

MOD222

CAUTION

When the lift support is detached from cargo box, the box can drop with force. Take care when operating the box without lift support.

2. Remove the nut securing the upper lift support bolt; then with the cargo box secured in place, remove the bolt.

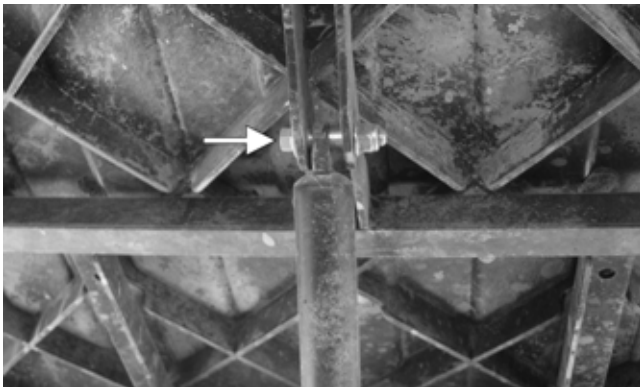

MOD611

3. Unfasten clip from lower lift support; then remove clip.

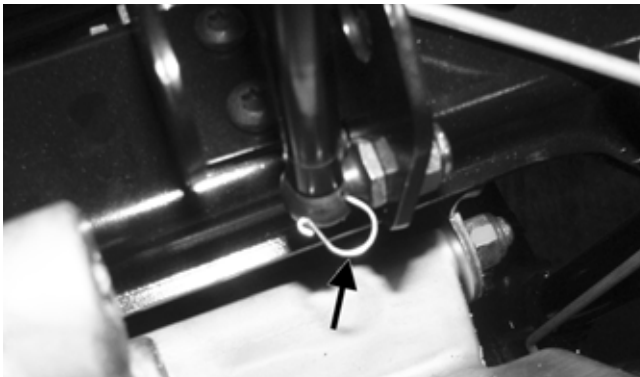

MOD223

4. Remove lift support from mounting; then carefully lower the cargo box to the down position.

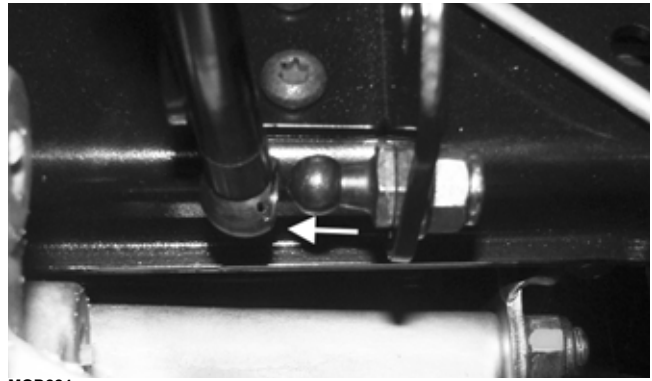

MOD224

5. Remove the two cap screws and nuts on the hinge points.

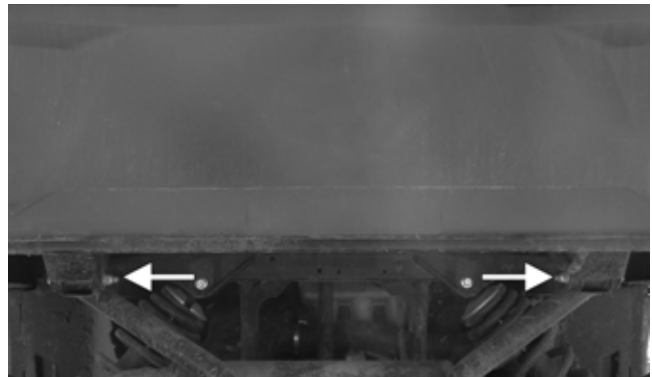

MOD608

6. With the help of an assistant or an adequate lift, remove the cargo box from the vehicle. The cargo box tilt lever will need to be released.

CLEANING AND INSPECTING

1. Clean all cargo box components with soap and water.
2. Inspect the cargo box for cracks, tears, and loose hardware.
3. Inspect the welds of the cargo box frame for cracking or bending.
4. Inspect the cargo box gate latches for smooth operation.

INSTALLING

1. Lightly grease the hinge points; then with the help of an assistant or an adequate lift, set the cargo box into position on the frame; then position the two hinge points between the cargo box and frame.
2. Align the holes in the hinge points with the holes in the cargo box; then install the two cap screws and nuts. Tighten to 30 ft-lb (40.8 N-m).
3. Raise the cargo box; then connect the lift support to the lower mounting, and secure the clip on the lower lift support; then install the cap screw and nut for the upper lift support, and tighten to 10 ft-lb (13.6 N-m).
4. Connect the electrical connection near the passenger side cargo box pivot point; then lower the cargo box and lock into position.

Seats

REMOVING/INSTALLING PASSENGER SEAT BOTTOMS

1. To remove a passenger seat bottom, raise the front of the seat and unhook both of the “C” channels of the seat bottom (B) out of the mounting pegs (A).

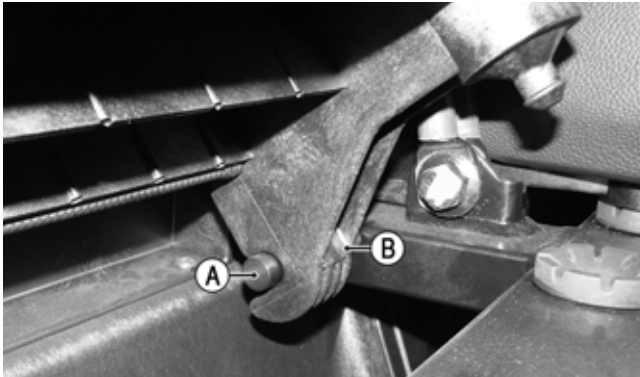

MOD248

2. Install the seat bottom by hooking both of the “C” channels of the seat bottom into the mounting pegs (A).

PASSENGER SEAT BACKREST REMOVING

1. Unlatch the passenger seat backrest; then fold down. Unhook both of the tubes of the seat backrest (A) out of the “C” channels (B).



MOD121A

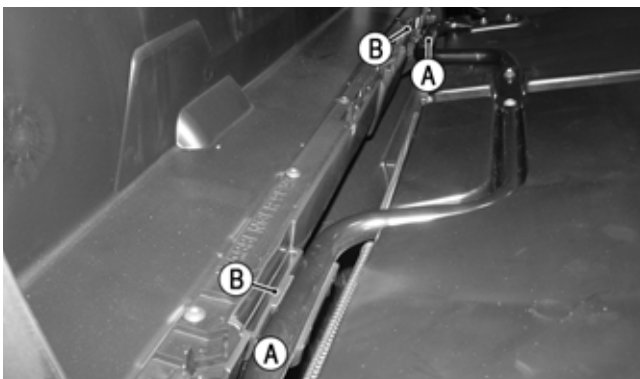

MOD226

DISASSEMBLING

1. Remove the six cap screws securing the passenger seat backrest to the passenger seat backrest frame; then remove the passenger seat backrest from the passenger seat backrest frame.

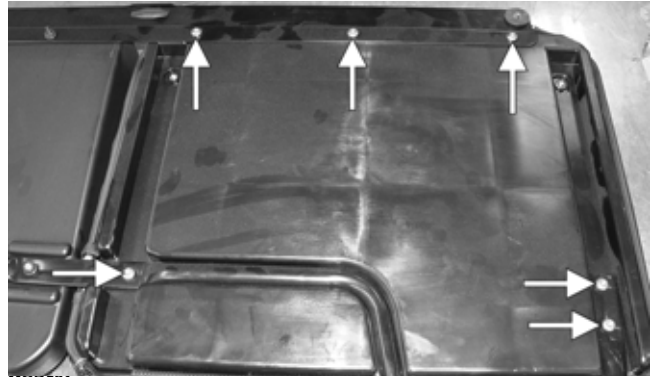

MOD521

2. Remove the five flange nuts securing the passenger seat backrest to the passenger seat backrest frame; then remove the passenger seat backrest from the passenger seat backrest frame.

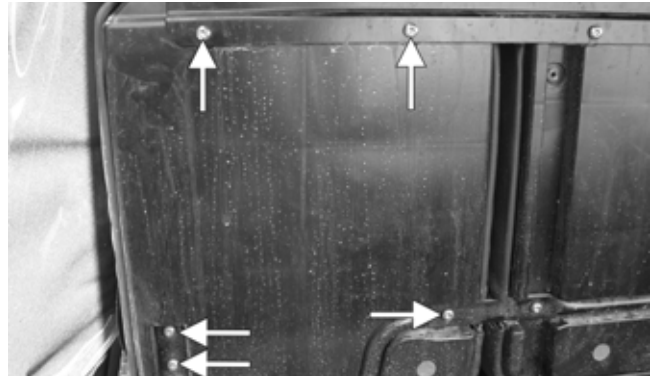

MOD609

ASSEMBLING

1. Position the passenger seat backrest to the passenger seat backrest frame; then install the six cap screws securing the passenger seat backrest to the passenger seat backrest frame. Tighten to 2 ft-lb (2.7 N-m).

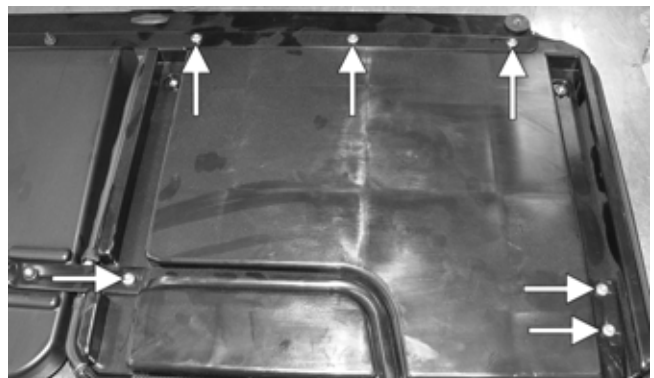

MOD521

2. Position the center passenger seat back to the passenger seat backrest frame; then install the five flange nuts securing the center passenger seat back to the passenger seat backrest frame. Tighten to 4 ft-lb (5.4 N-m).

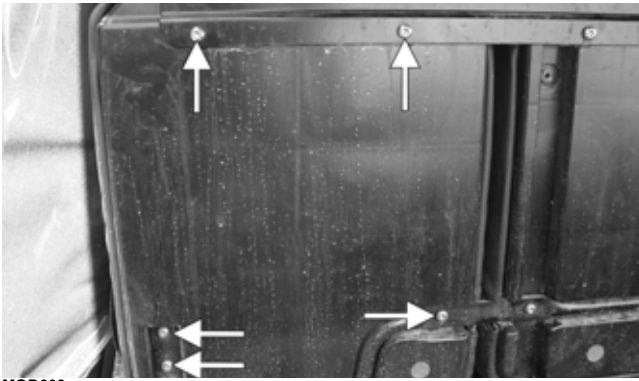

MOD609

INSTALLING

1. Install the seat backrest by hooking both of the tubes of the seat backrest (A) into the "C" channels (B). Fold up; then close the seat backrest latch.

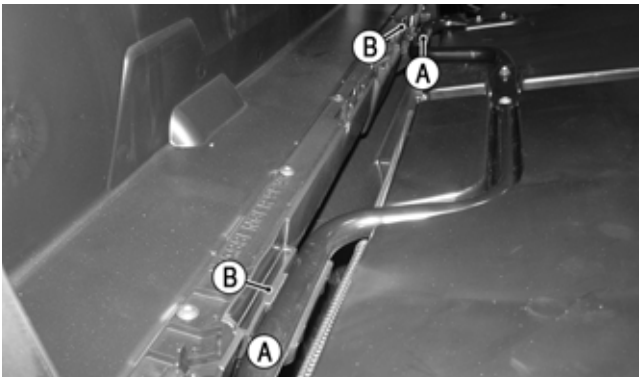

MOD226



MOD165

DRIVER SEAT REMOVING

1. Remove the six cap screws from underneath the driver seat rails.



MOD661

2. Lift the seat adjustment lever; then move the seat assembly toward the front of the vehicle to clear the rear mounting channel.

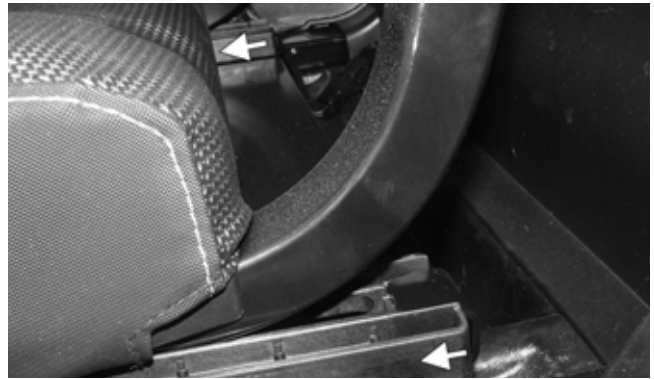

MOD228

DISASSEMBLING

1. Remove the four cap screws securing the seat bottom to the seat assembly; then remove the seat bottom from the seat assembly.



MOD523

2. Remove the four cap screws securing the seat backrest to the seat assembly; then remove the seat backrest from the seat assembly.

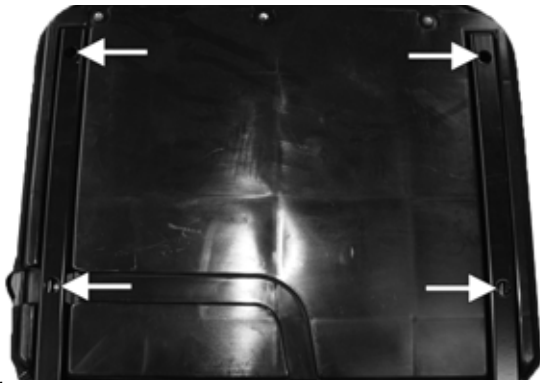

MOD524

ASSEMBLING

1. Position the seat bottom to the seat assembly; then install the four cap screws securing the seat bottom to the seat assembly. Tighten to 2 ft-lb (2.7 N-m).

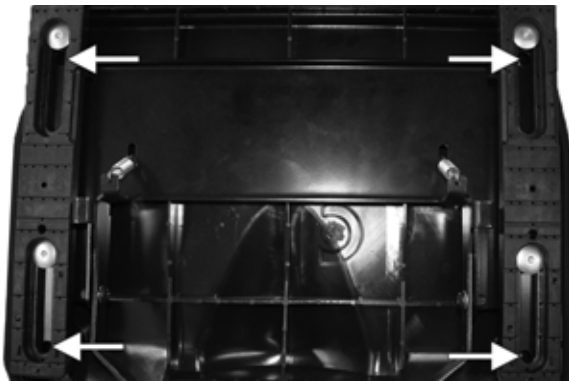

MOD523

2. Position the seat backrest to the seat assembly; then install the four cap screws securing the seat backrest to the seat assembly. Torque to 2 ft-lb (2.7 N-m).

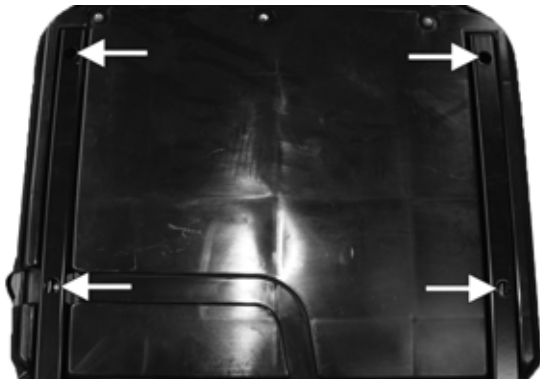

MOD524

INSTALLING

1. Install the seat assembly by lifting up on the seat adjustment lever; then move the seat assembly toward the rear of the vehicle to hook into the rear mounting channels.

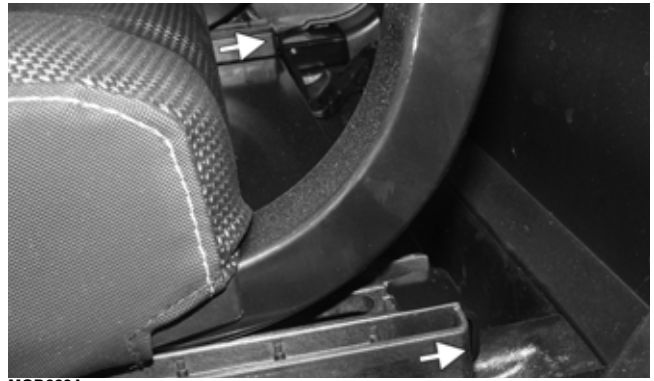

MOD228A

2. Install the six cap screws underneath the driver seat rails. Tighten to 2 ft-lb (2.7 N-m).



MOD661

REAR DRIVER-SIDE SEAT BACK

Removing

1. Remove the rear driver side seat bottom.
2. Remove the two cap screws at the top of the seat back (A).

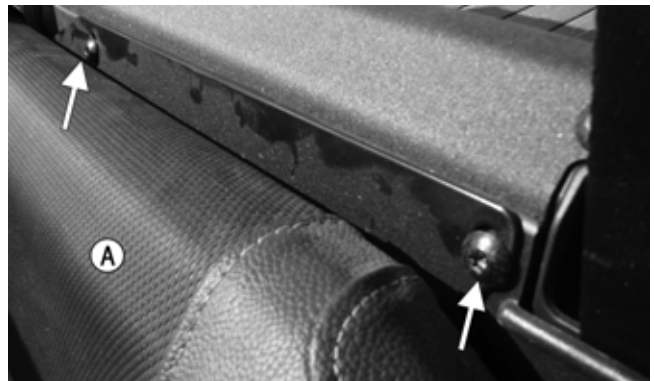

MOD639

3. Remove the two cap screws at the bottom of the seat back; then remove the seat back assembly.

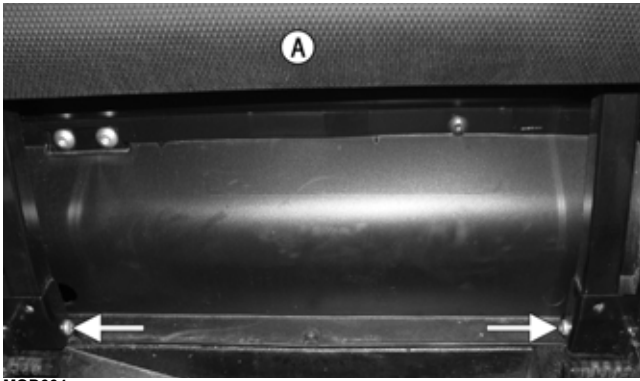

MOD664

Installing

1. Position the seat back assembly into place; then install the two cap screws at the bottom of the seat back.

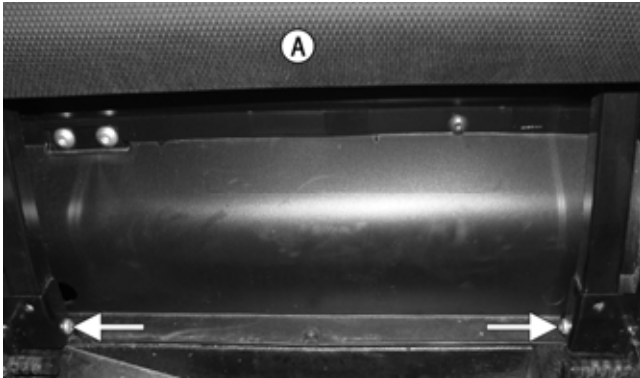

MOD664

2. Install the two cap screws at the top of the seat back (A).

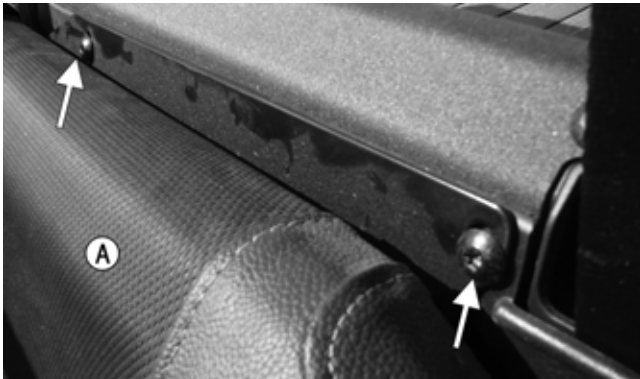

MOD639

3. Install the rear driver-side seat bottom.

Behind-the-Seat Storage Box Panel

REMOVING

1. Remove the rear seats; then both rear inner fenders; then both rear side panels.
2. Remove the four cap screws and hose clamp for the CVT air inlet snorkel.

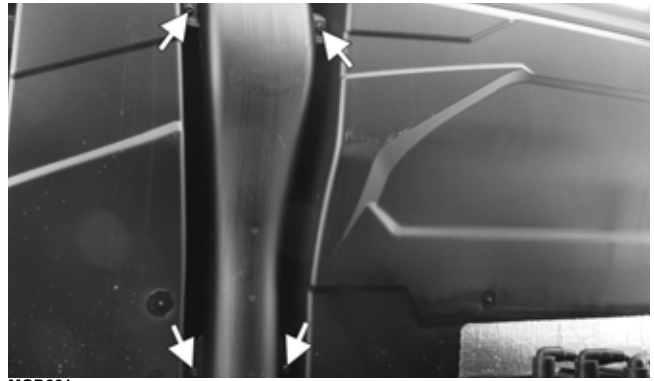

MOD281

3. Remove the 11 cap screws securing the passenger seat backrest hinge; then remove the passenger seat backrest hinge.

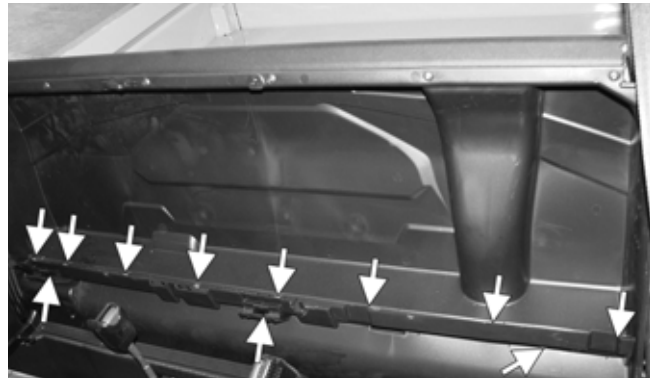

MOD280A

4. Remove the two cap screws on each seat belt guide; then remove seat belt guides; then disconnect the seat belt electrical connector.



MOD282

5. Remove the cap screw on each of the outer portions of the behind-the-seat storage box panel.

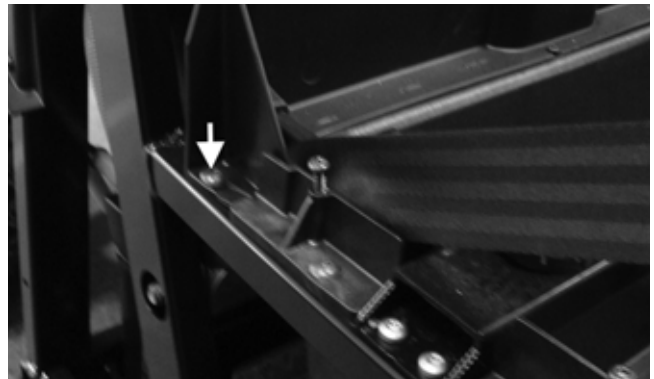

MOD283

- Disconnect the two electrical connections to the ECU (A) that is located in front of the engine air filter.



MOD593

- Remove the four cap screws securing the behind-the-seat storage box panel; then remove the eight cap screws securing the behind-the-seat storage box panel to the floor; then remove the rear center seat belt; then remove the behind-the-seat storage box panel.

NOTE: When removing the behind-the-seat storage box panel, it might be necessary to gently pull down on the top of the panel to clear the metal channel that connects the left and right rear ROPS.

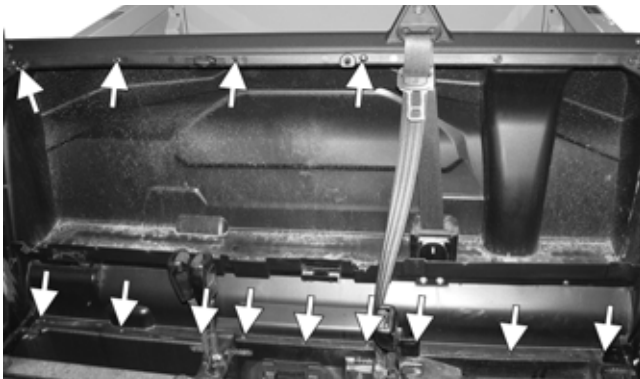

MOD665

INSTALLING

- Gently position the behind-the-seat storage box panel into position; then reinstall the four cap screws on the top of the panel; then install the eight cap screws securing the behind-the-seat storage box panel to the floor; then install the rear center seat belt.

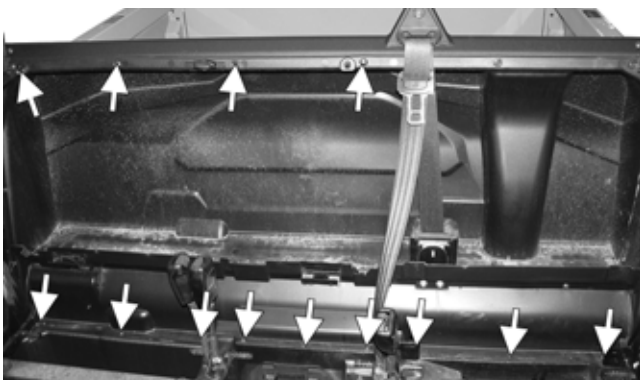

MOD665

- Reinstall the cap screw on each of the outer portions of the behind-the-seat storage box panel.

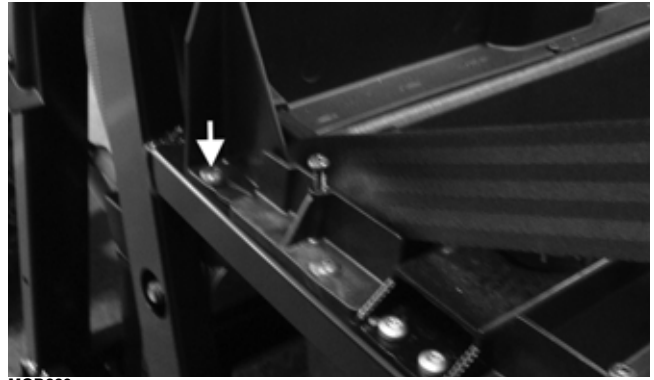

MOD283

- Reinstall both seat belt guides; then reinstall the two cap screws on each seat belt guide; then connect the seat belt electrical connector.



MOD282

- Reinstall the passenger seat back hinge; then reinstall the 11 cap screws securing the passenger seat back hinge.

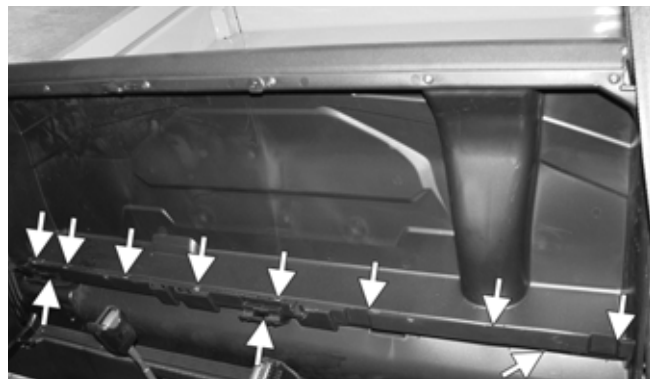

MOD280A

- Reinstall the four cap screws and hose clamp for the CVT air inlet snorkel.

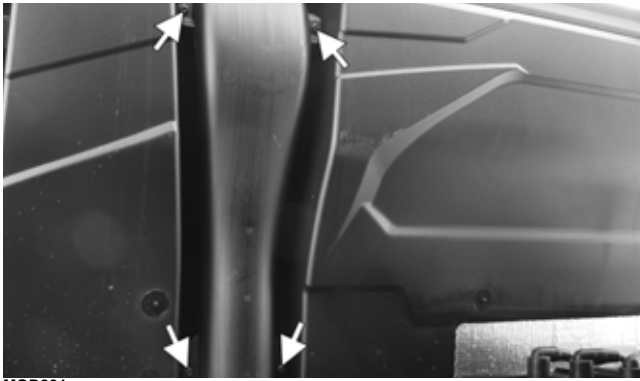

MOD281

6. Reconnect the two electrical connectors to the ECU (A).

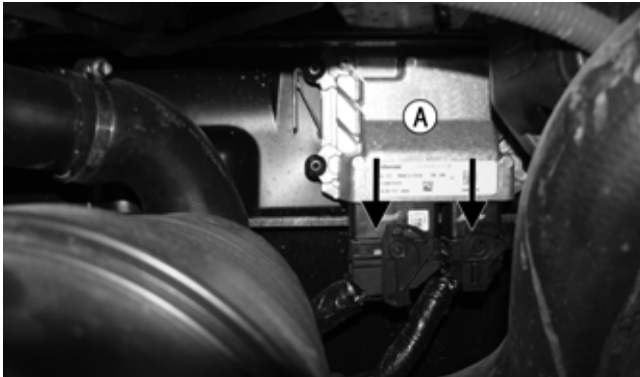

MOD593

7. Reinstall the rear seats; then both rear side panels; then both rear inner fenders.



MOD696



MOD673

4. Remove the five cap screws at the bottom of the behind-the-seat close off panel.

Behind-the-Seat Close Off Panel

REMOVING

1. Remove both front side panels.
2. Remove the six cap screws that secure the rear panel to the center ROPS.

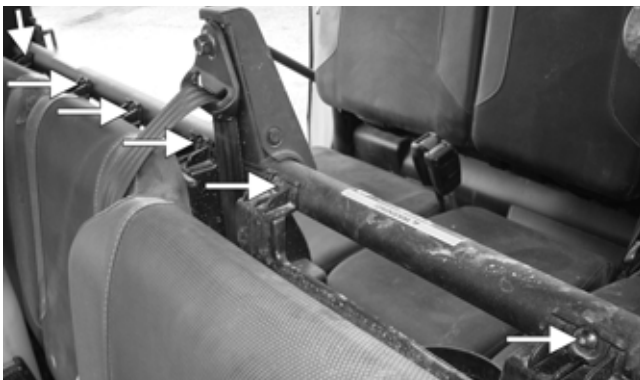

MOD697

3. Remove the two cap screws behind the center seat; then remove the two cap screws behind the passenger seat.

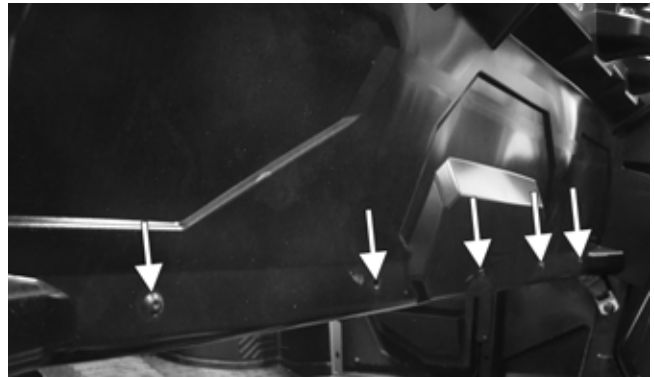

MOD669

5. Remove the five cap screws near the cup holders; then remove the behind-the-seat close off panel.

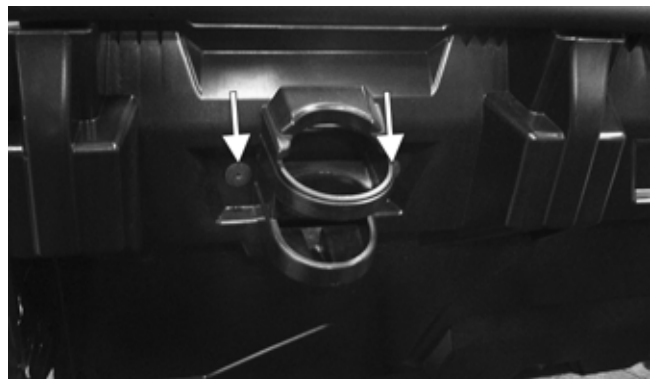

MOD671

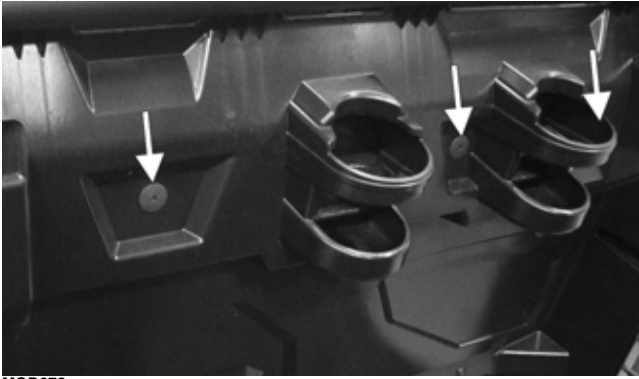

MOD672

INSTALLING

1. Position the behind-the-seat close off panel into place; then reinstall the five cap screws near the cup holders.

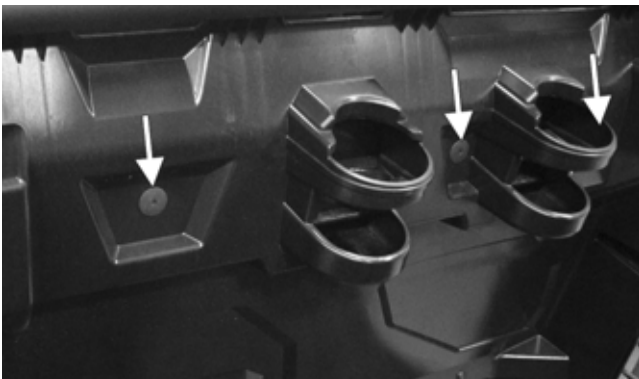

MOD672

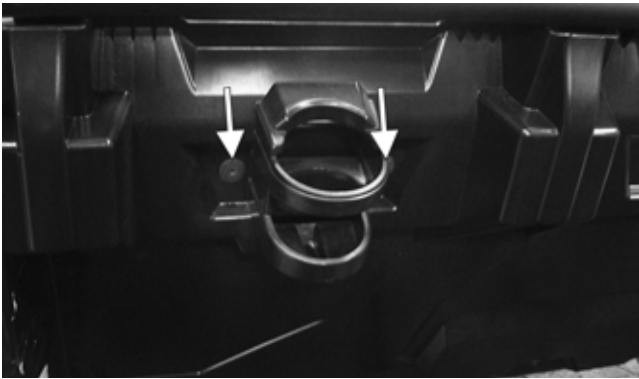

MOD671

2. Reinstall the five cap screws at the bottom of the behind-the-seat close off panel.

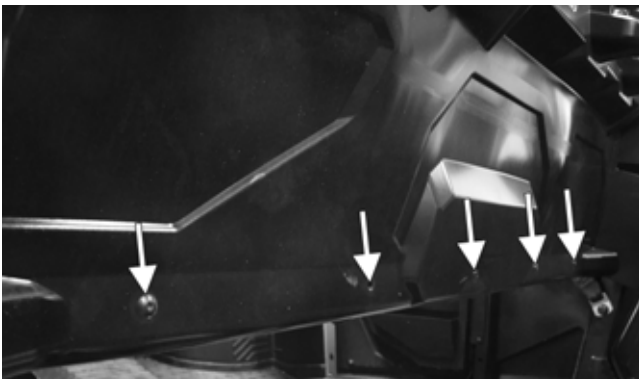

MOD669

3. Reinstall the two cap screws behind the center seat; then reinstall the two cap screws behind the passenger seat.



MOD696



MOD673

4. Reinstall the six cap screws that secure the rear panel to the center ROPS.



MOD697

5. Reinstall both front side panels.

Rear Seat Base

REMOVING

1. Remove the rear seats; then remove the rear inner fenders and rear side panels; then remove the behind-the-seat storage box panel.
2. Remove the 12 cap screws securing the seat base; then remove the seat base.

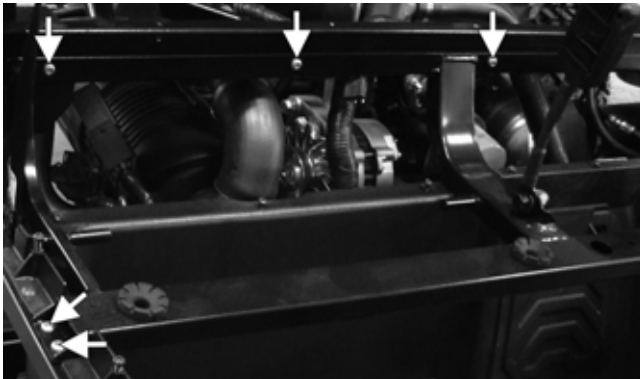

MOD666

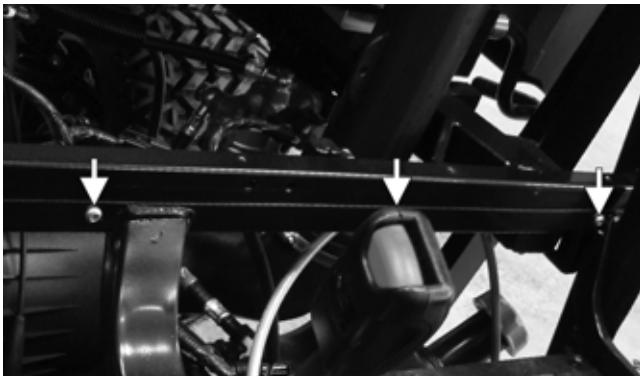

MOD667



MOD668

INSTALLING

1. Position the seat base back into position; then secure using 12 cap screws.



MOD668

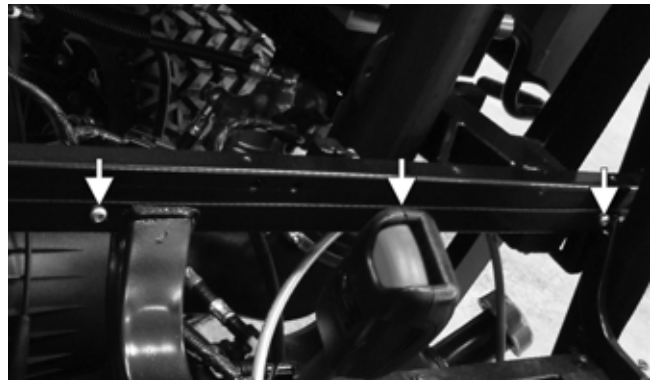

MOD667

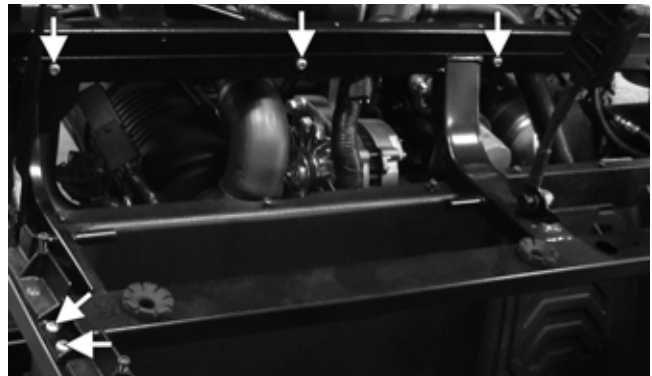

MOD666

2. Reinstall the behind-the-seat storage box panel; then reinstall the rear side panels and rear inner fenders; then reinstall the rear seats.

Troubleshooting

| Problem: Handling too heavy or stiff | |
|------------------------------------------------------------------------------------------------------------------------------------------------------------------------------------------------------------------------------------------------------------------------------------------------------------------------------------------------------------------------------------------------------------------|------------------------------------------------------------------------------------------------------------------------------------------------------------------------------------------------------------------------------------------------------------------------------------------------------------|
| Condition | Remedy |
| <ol style="list-style-type: none"> 1. Front wheel alignment incorrect 2. Steering shaft binding 3. Tire inflation pressure incorrect 4. Tie rod ends seizing 5. U-joints seized 6. EPS not working | <ol style="list-style-type: none"> 1. Adjust alignment 2. Lubricate/replace steering shaft 3. Adjust pressure 4. Replace tie rod ends 5. Replace U-joints 6. Diagnose EPS |
| Problem: Steering oscillation | |
| Condition | Remedy |
| <ol style="list-style-type: none"> 1. Tires inflated unequally 2. Wheel(s) bent 3. Wheel hub studs loose — missing 4. Wheel hub bearing worn — damaged 5. Tie rod ends worn — loose 6. Tires defective — incorrect 7. A-arm bushings damaged 8. Bolts — nuts (frame) loose | <ol style="list-style-type: none"> 1. Adjust pressure 2. Replace wheel(s) 3. Tighten — replace wheel studs 4. Replace bearing 5. Replace — tighten tie rod ends 6. Replace tires 7. Replace bushings 8. Tighten bolts — nuts |
| Problem: Steering pulling to one side | |
| Condition | Remedy |
| <ol style="list-style-type: none"> 1. Tires inflated unequally 2. Front wheel alignment incorrect 3. Wheel hub bearings worn — broken 4. Frame distorted 5. Shock absorber defective | <ol style="list-style-type: none"> 1. Adjust pressure 2. Adjust alignment 3. Replace bearings 4. Repair — replace frame 5. Replace shock absorber |
| Problem: Steering impaired | |
| Condition | Remedy |
| <ol style="list-style-type: none"> 1. Tire pressure too high 2. Steering linkage worn 3. Cap screws (suspension system) loose | <ol style="list-style-type: none"> 1. Adjust pressure 2. Replace linkage 3. Tighten cap screws |
| Problem: Tire wear rapid or uneven | |
| Condition | Remedy |
| <ol style="list-style-type: none"> 1. Wheel hub bearings worn — loose 2. Front wheel alignment incorrect | <ol style="list-style-type: none"> 1. Replace bearings 2. Adjust alignment |
| Problem: Steering noise | |
| Condition | Remedy |
| <ol style="list-style-type: none"> 1. Caps screws — nuts loose 2. Wheel hub bearings broken — damaged 3. Lubrication inadequate | <ol style="list-style-type: none"> 1. Tighten cap screws — nuts 2. Replace bearings 3. Lubricate appropriate components |
| Problem: Rear wheel oscillation | |
| Condition | Remedy |
| <ol style="list-style-type: none"> 1. Rear wheel hub bearings worn — loose 2. Tires defective — incorrect 3. Wheel rim distorted 4. Wheel hub studs loose — missing 5. Rear suspension arm-related bushing worn 6. Rear shock absorber damaged 7. Rear suspension arm nut loose | <ol style="list-style-type: none"> 1. Replace bearings 2. Replace tires 3. Replace rim 4. Tighten — replace wheel studs 5. Replace bushing 6. Replace shock absorber 7. Tighten nut |

Engine

This section has been organized into sub-sections which show a progression for the complete servicing of the engine.

■**NOTE:** Photographs are used for clarification purposes only and may not depict exact situation.

To service the crankshaft, the engine must be removed from the frame. To service top-side, left-side, and right-side components, the engine does not have to be removed from the frame.

■**NOTE:** It is recommended to use new gaskets, lock nuts, and seals and lubricating all internal components when servicing the engine.

■**NOTE:** A new ROV and an overhauled ROV engine require a “break-in” period. The first 50 hours are most critical to the life of this ROV. Proper operation during this break-in period will help ensure maximum life and performance from the ROV. Instruct the customer to follow the proper break-in procedure as described in the Operators Manual.

SPECIAL TOOLS

A number of special tools must be available to the technician when performing service procedures in this section. Refer to the current Special Tools Catalog for the appropriate tool description.

■**NOTE:** When indicated for use, each special tool will be identified by its specific name, as shown in the chart below, and capitalized.

| Description | p/n |
|------------------------------|----------|
| Drive Clutch Puller | 0744-080 |
| Drive and Driven Holder Tool | 0444-317 |
| Valve Adjust Tool | 0443-308 |

■**NOTE:** Special tools are available from the Service Department.

Removing Engine

Many service procedures can be performed without removing the engine from the frame. Closely observe the note introducing each sub-section for this important information.

Support the vehicle on a suitable lift or jack stands allowing room to perform work from the underside.

1. Remove the cargo box; then remove both the rear inner fenders.
2. Remove the clutch cover; then remove the driven clutch, drive belt, and drive clutch (see Servicing Left-Side Components in this section).



MOD533

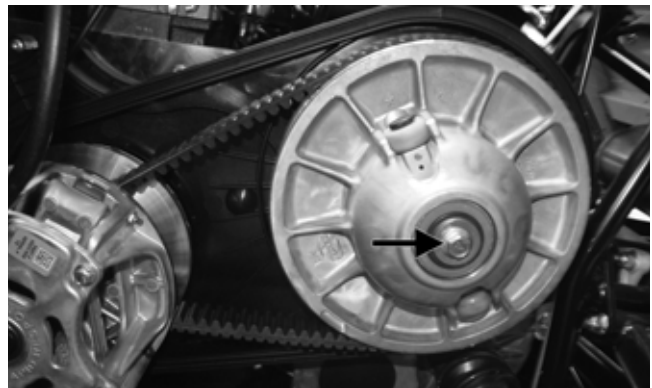

MOD213

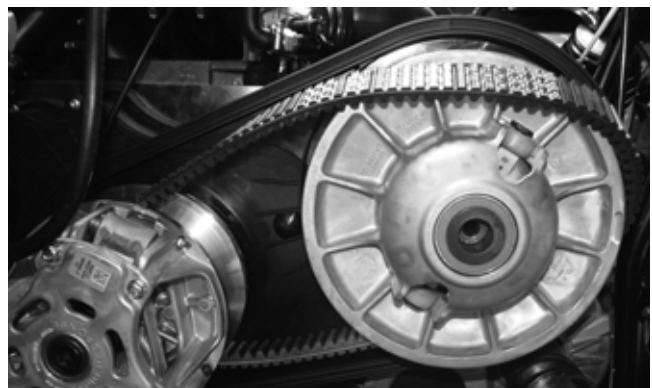

MOD215



MOD390

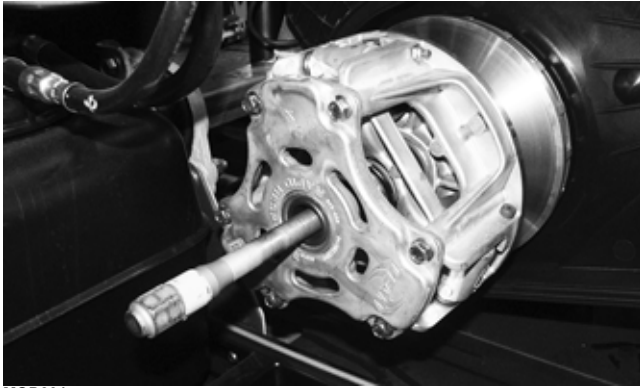

MOD391

3. Near the engine PTO, remove the retaining ring securing the inner clutch cover to the engine; then near the transaxle input shaft remove the four cap screws securing the inner clutch cover to the transaxle; then remove the inner clutch cover.

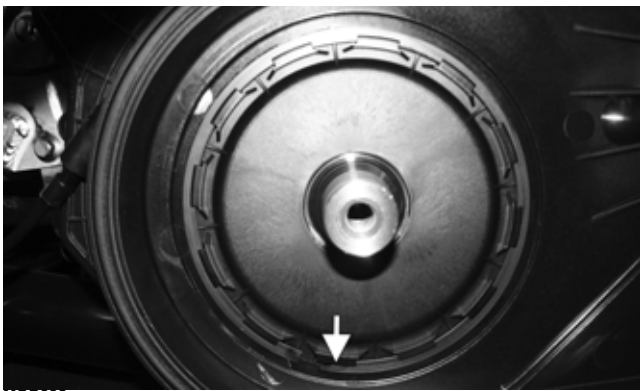

MOD392

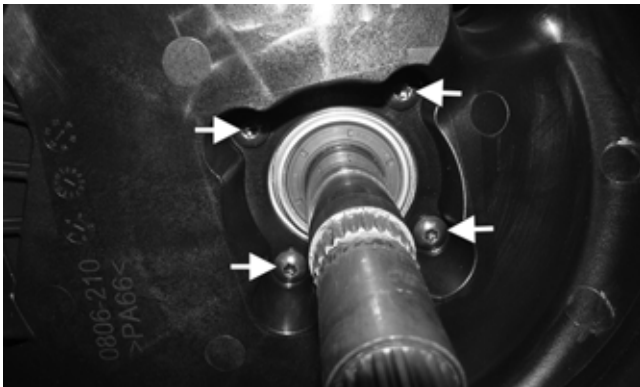

MOD393

4. Disconnect the battery connections; then disconnect the starter wire (A) and start relay wire (B).

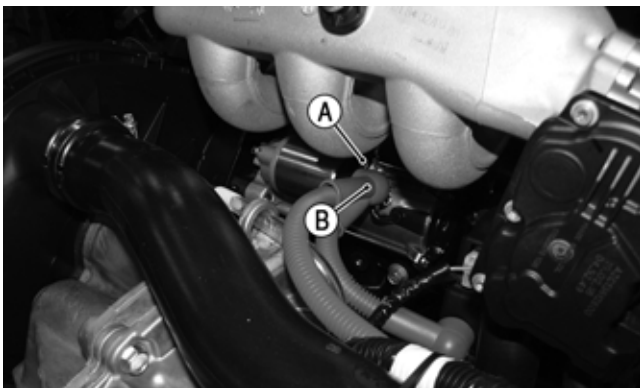

MOD538

5. Remove the flywheel cover; then remove the PTO stub shaft; then remove the crank position sensor from the crank position sensor bracket.

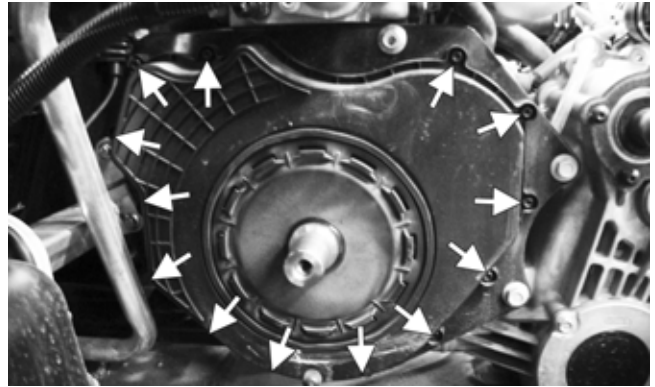

MOD539

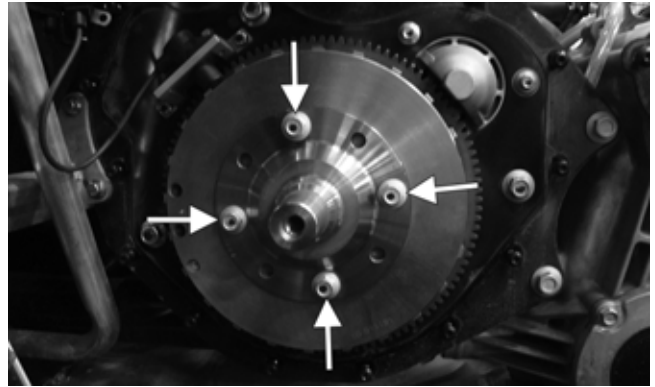

MOD540

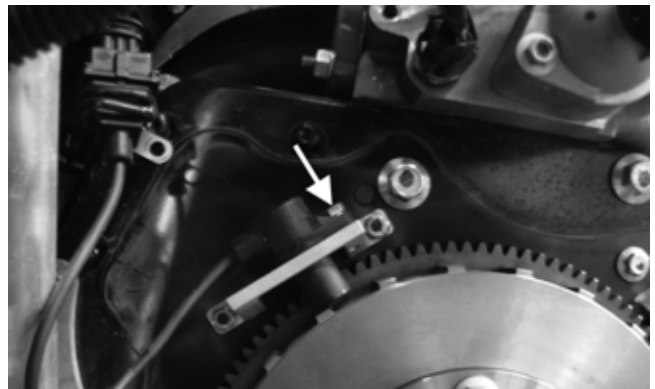

MOD541A

6. Remove the flywheel; then with a suitable lift put a slight upward tension on the engine; then with a suitable strap or lift put a slight upward tension on the transaxle.

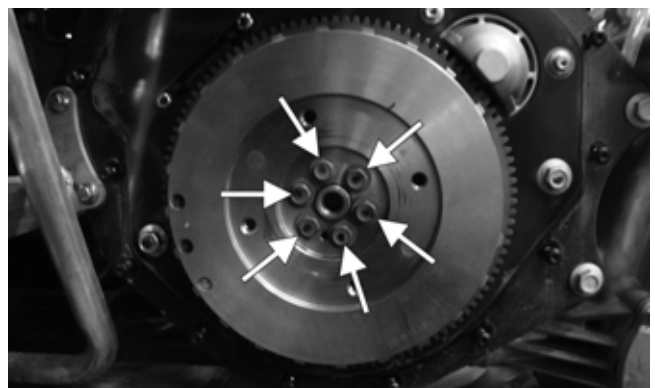

MOD542

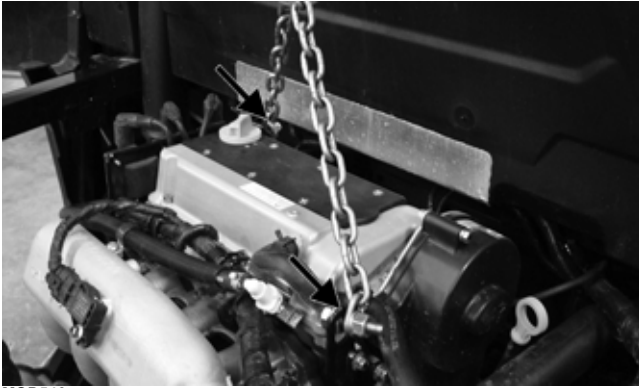

MOD546

7. Remove the two cap screws securing the engine to the transaxle. Account for the spacers and washers between the engine and transaxle.

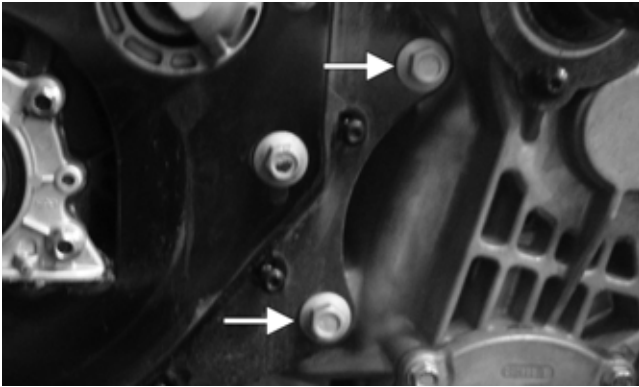

MOD543

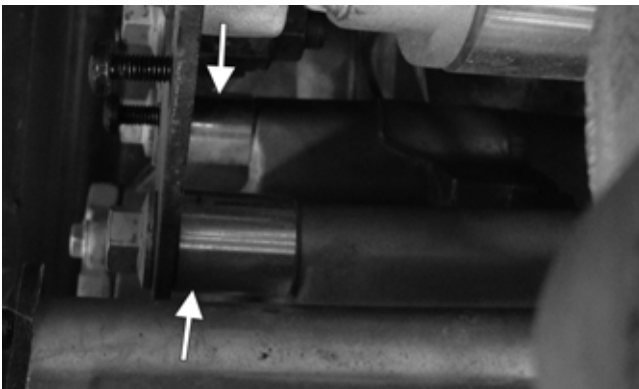

MOD554

8. Remove the two cap screws securing the starter to the engine backplate; then remove the starter; then remove the two cap screws securing the driver-side backplate to the front mount; then remove the four cap screws for the engine backplate and remove the engine backplate.

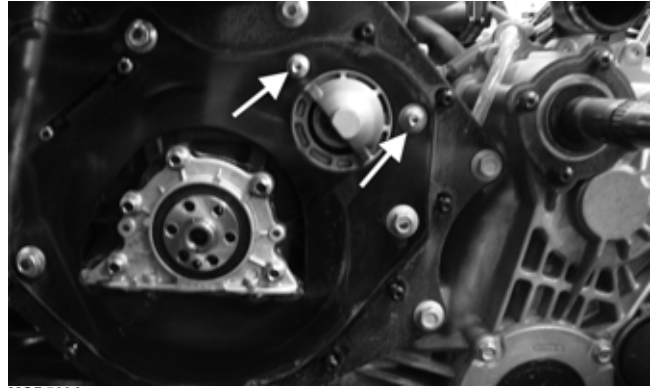

MOD563A



MOD544

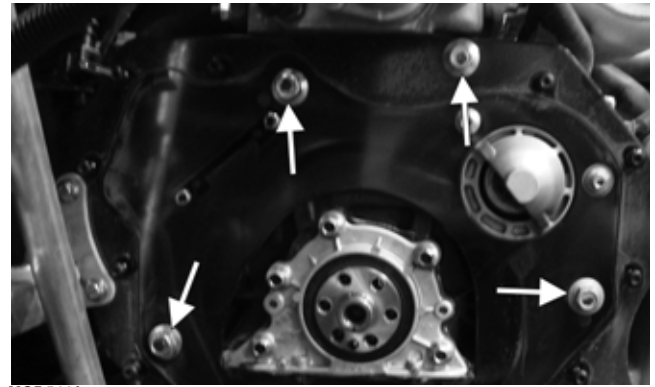

MOD544A

9. Remove the air intake to the engine.

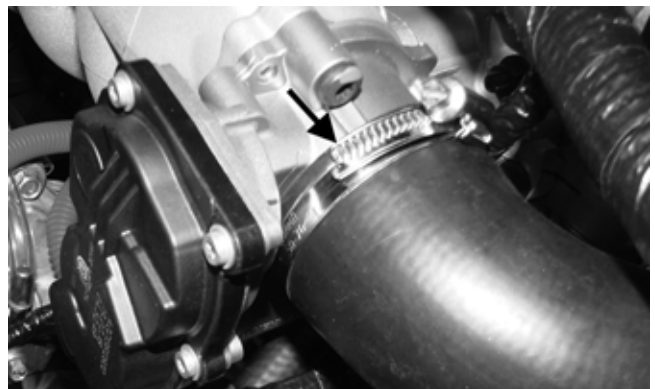

MOD545

10. With tape or other suitable means, plug the intake for the engine to prevent foreign debris from entering.



MOD548

11. Remove the two cap screws and nuts securing the exhaust to the exhaust manifold; then gently pull the exhaust from the exhaust manifold.

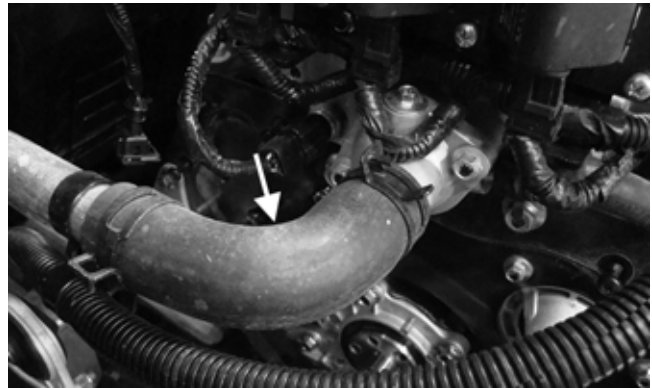

MOD551

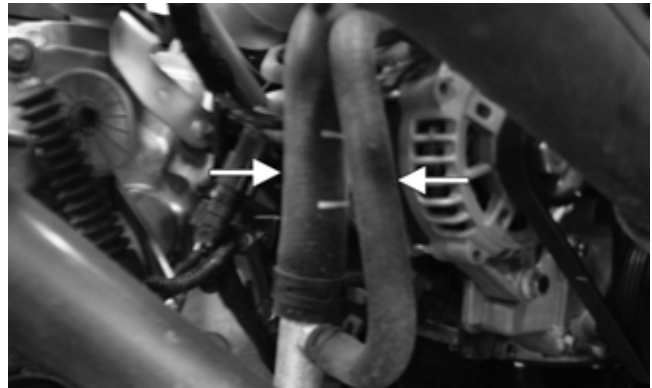

MOD552

■NOTE: Coolant will come out when removing the coolant hoses. It is recommended to have a drain pan or suitable absorbant material near when removing coolant hoses.

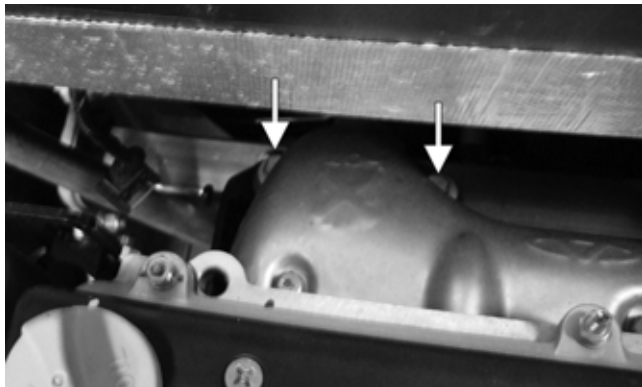

MOD549

■NOTE: When removing the four cap screws in the next step, the engine will be completely unsecured in the chassis

12. Remove the four cap screws at the front of the engine below the engine oil filter.

14. Remove the driver-side coolant hose from the engine; then remove the coolant hose above the starter; then remove the coolant hose near the engine intake.

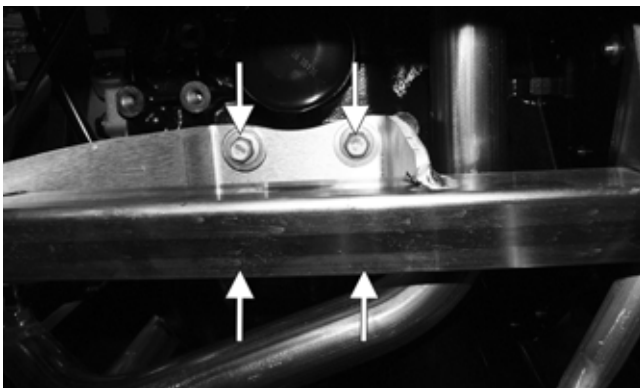

MOD550

13. Using suitable clamps, clamp the areas indicated to minimize coolant leakage.



MOD405



MOD553

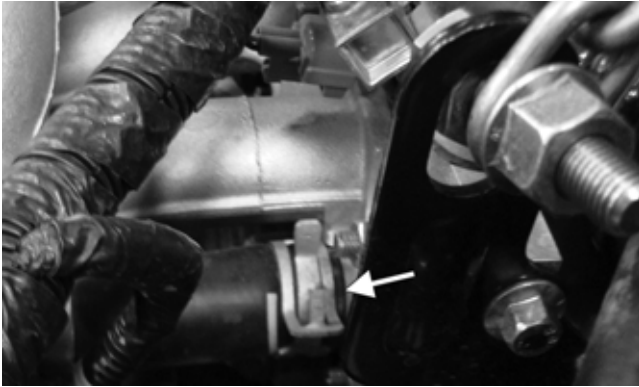

MOD555

15. Remove the coolant sensor connector from the coolant sensor; then disconnect the coil connectors from the coils; then remove the engine oil pressure switch connector from the engine oil pressure switch that is located near the engine oil filter; then remove the engine ground located above the engine oil pressure switch.

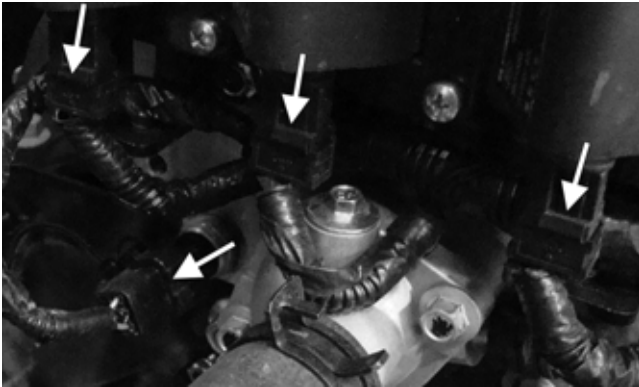

MOD556

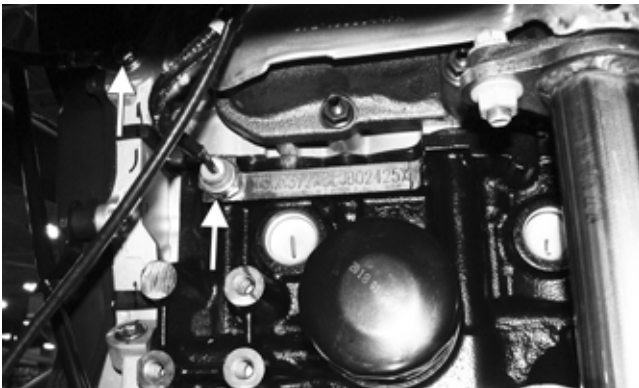

MOD557

16. Remove the wires going to the alternator; then remove the temperature/manifold absolute pressure (TMAP) sensor connector from the temperature/manifold absolute pressure (TMAP) sensor.

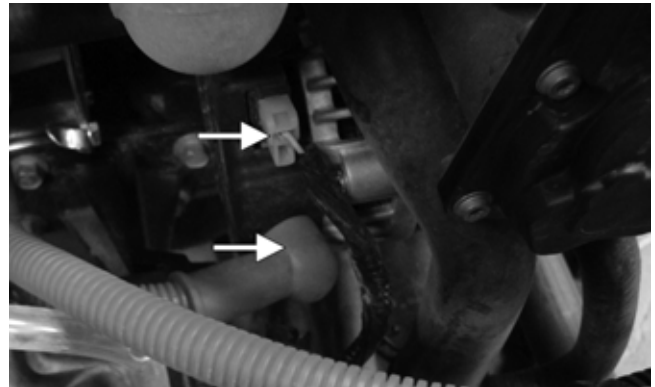

MOD558



MOD559

17. Disconnect the gas line from the injector rail; then disconnect each injector connector from the injector; then disconnect the electronic throttle control (ETC) connector from the ETC.

| |
|--------------------------------------------------------------------------------------------------------------------------------------------------------------------------------|
|  WARNING |
| Whenever any maintenance or inspection is made on the fuel system during which there may be fuel leakage, there should be no welding, smoking, open flames, etc., in the area. |

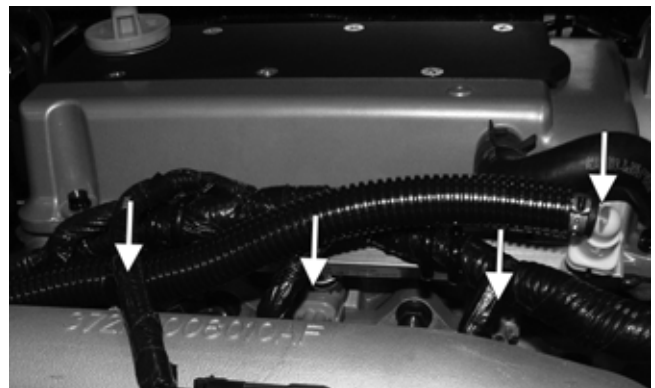

MOD561

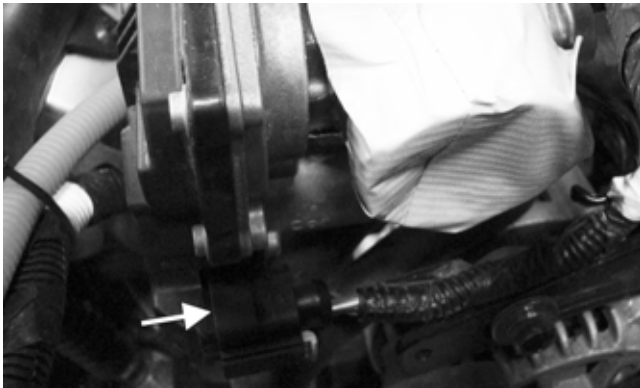

MOD560

18. Gently remove the engine from the chassis, being careful of any electrical components, hoses, straps, and etc.



MF031

Cylinder Head and Related Components

■NOTE: For efficiency, it is preferable to remove and disassemble only those components which need to be addressed and to service only those components. The technician should use discretion and sound judgment.

👉 AT THIS POINT

To service any one specific component, only limited disassembly of components may be necessary. Note the AT THIS POINT information in each sub-section.

■NOTE: The engine does not have to be removed from the frame for this procedure.

⚠️ WARNING

To avoid personal injury and equipment damage, the negative battery cable should be disconnected anytime engine maintenance is performed to prevent inadvertent starter engagement, shorting or arcing of wire connectors, or fuel pump actuation resulting in spilled gasoline and fire.

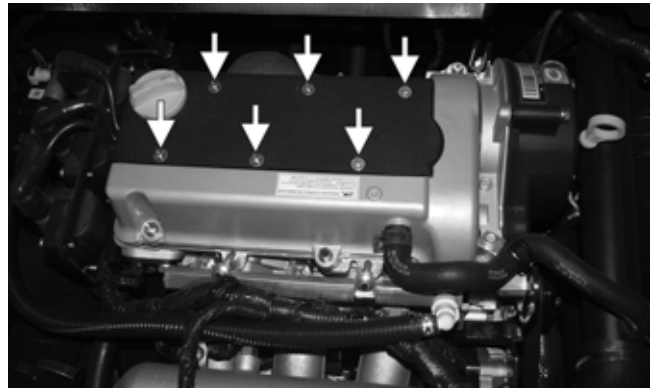

MOD536

3. Remove spark plug wires; then remove six cap screws securing valve cover to the cylinder head.

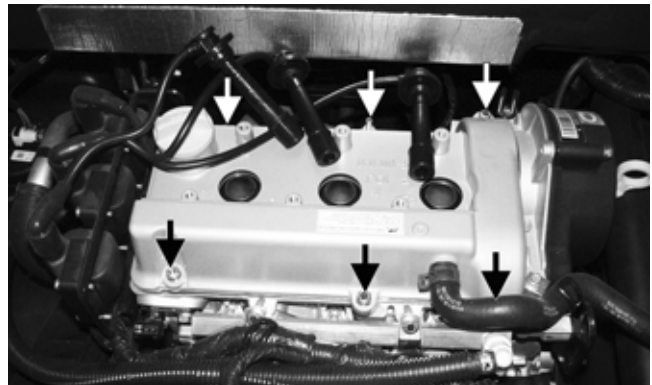

MOD537

4. Remove the valve cover. Account for the gasket.

■NOTE: Care should be taken not to damage the areas indicated. If the areas indicated are damaged or leaking, the valve cover must be replaced.

Removing Cylinder Head and Related Components

REMOVING VALVE COVER

■NOTE: Remove the spark plugs and timing inspection plug; then using a socket and ratchet, rotate the crankshaft to top-dead-center of the compression stroke.

1. Tilt the cargo box up; then disconnect the negative battery cable from the battery.
2. Disconnect the crankcase breather hose from the valve cover; then remove oil fill cap and six machine screws securing spark plug cover to valve cover.

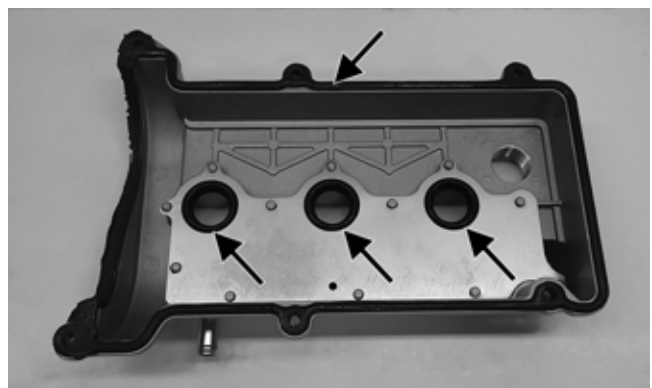

CD206

INSTALLING VALVE COVER

1. Thoroughly clean all gasket and sealing material from the valve cover and cylinder head; then using a new gasket and seals, apply a small amount of high temperature silicone sealant between the arrows on the valve cover as shown and install valve cover onto cylinder head.

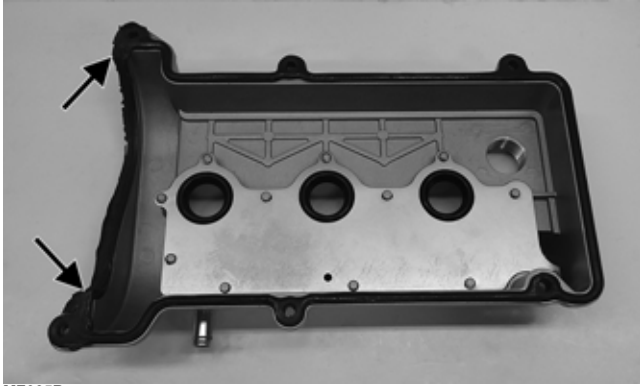

MF035B

2. Install cap screws and tighten evenly to specifications; then install spark plug wires, spark plug cover, oil fill cap, and breather hose.

CAUTION

Do not over-tighten as rubber gasket will become distorted resulting in oil leaks.

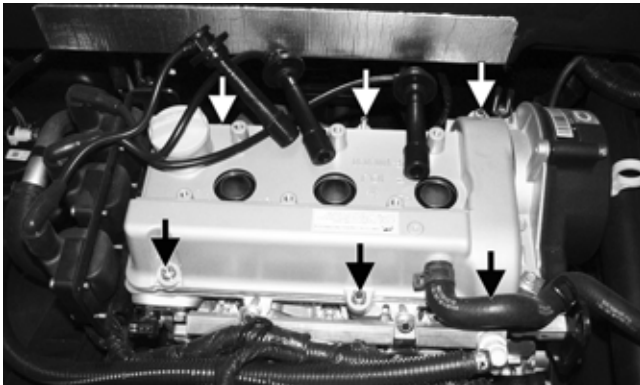

MOD537

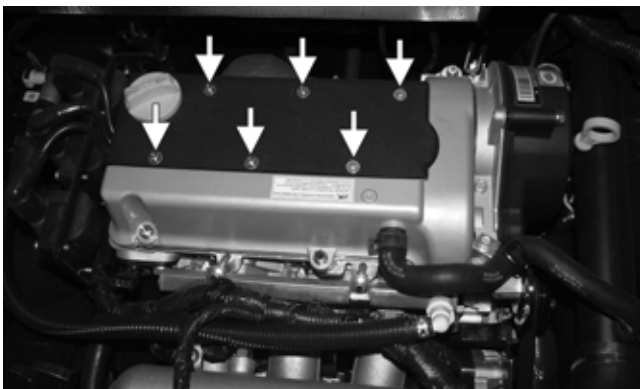

MOD536

CHECKING VALVE CLEARANCE

See Periodic Maintenance/Tune-Up section.

REMOVING AND INSTALLING CAMSHAFT DRIVE BELT

1. Disconnect the negative battery cable; then loosen the alternator mounting bolt (A) and adjusting cap screw (B) and remove serpentine drive belt.

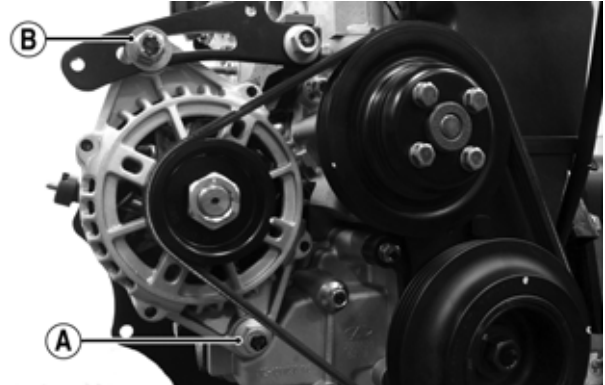

MF079A

2. Remove the water pump pulley (C) and crankshaft drive pulley (D); then remove the upper and lower camshaft drive belt covers (E).

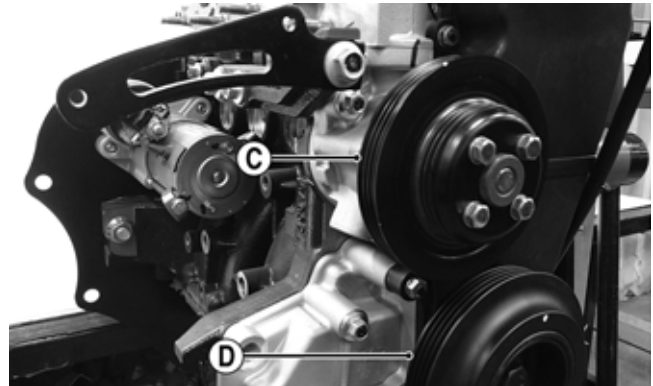

MF081A

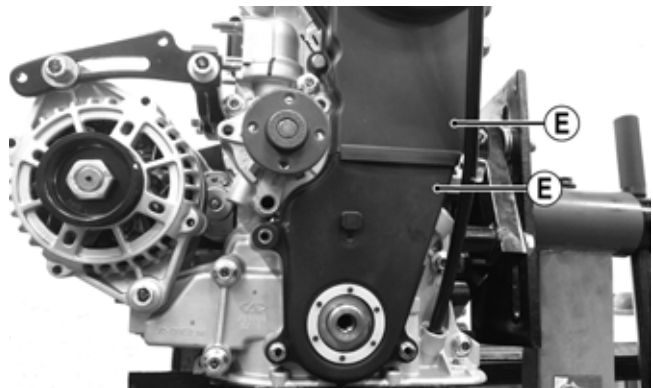

MF084A

3. Remove the belt guide.

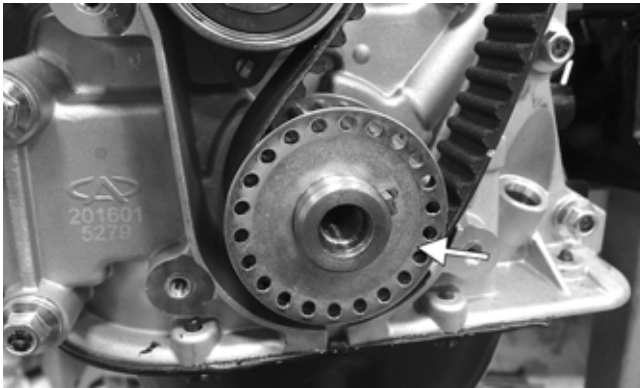

MF161A

4. Loosen the cap screw securing the camshaft drive adjuster pulley; then remove the timing belt and replace if damaged in any way.

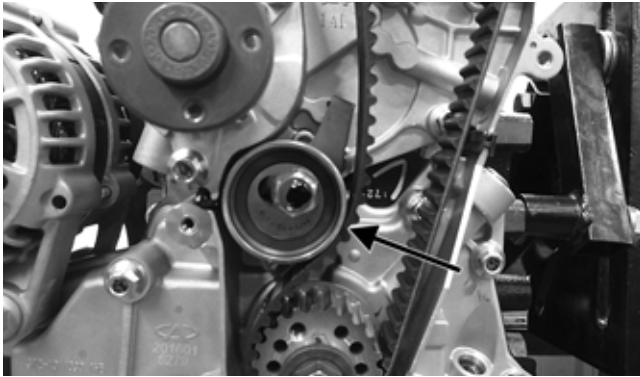

MF161A

■ **NOTE:** It is not advisable to reuse the timing belt once removed from the pulleys due to set wear patterns not realigning. The belt may be reused if:

- * very low time on belt
- * no missing cogs on belt
- * no cracks or threads showing
- * no evidence of being contaminated with oil or coolant

5. Inspect the cogged pulleys for excessive wear, broken or missing cogs, or build-up of dirt and debris between the cogs. Replace if cracked, worn excessively, or cogs missing.

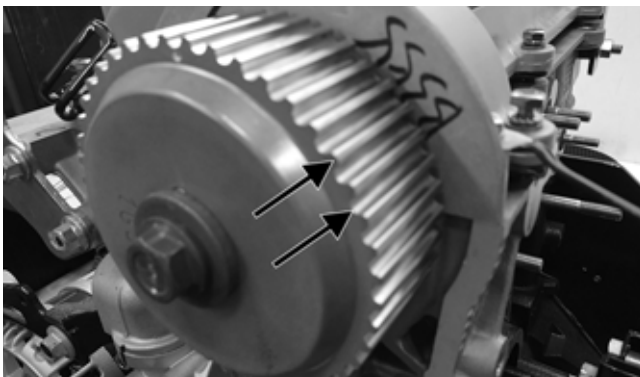

MF092A

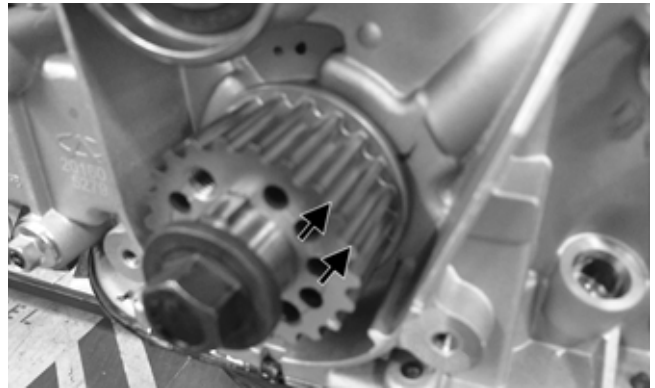

MF093A

6. Inspect belt tensioner for excessive wear, binding, or rough bearing feel. Replace as necessary.

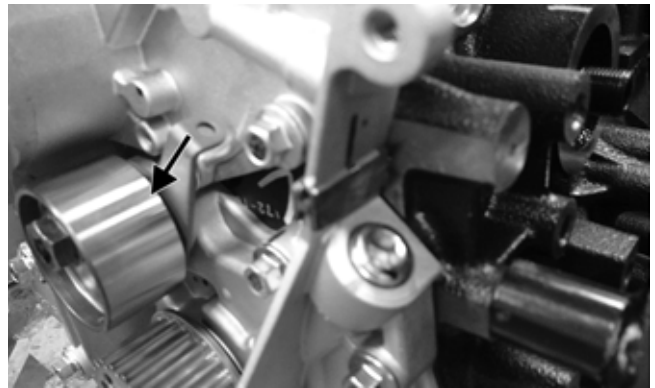

MF094A

7. Rotate the camshaft driven pulley to align the timing mark (F) on the pulley with the reference mark (G) on the camshaft retainer housing.

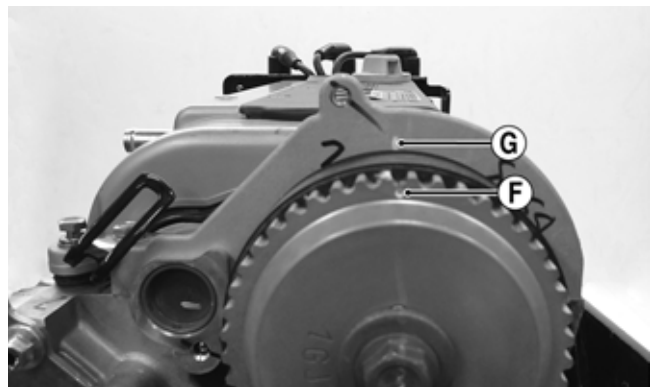

MF087A

8. Rotate the crankshaft to align the timing mark (H) on the drive pulley to the reference mark (I) on the oil pump housing.

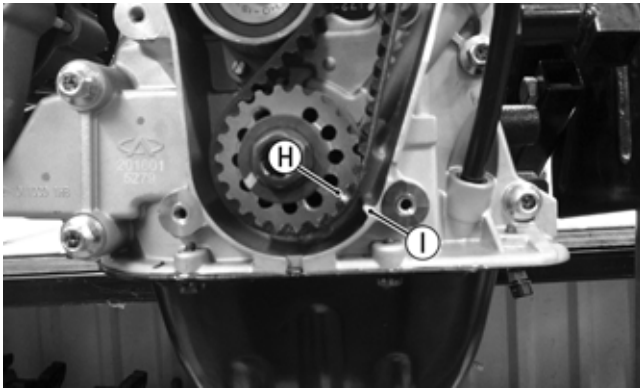

MF088A

9. Install a new timing belt keeping the timing marks aligned; then push tensioner arm in the direction of the arrow until the gap between the tensioner and water pump housing is 5 mm (0.2 in.) and tighten the tensioner cap screw securely.

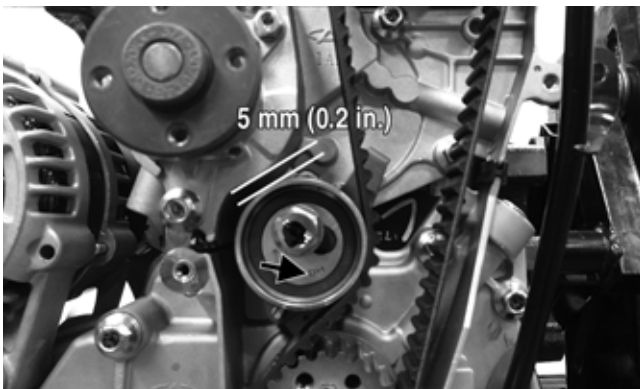

MF088A

10. Rotate the crankshaft clockwise two turns, aligning the timing marks again; then loosen the tensioner cap screw and apply pressure to the arm so as to obtain a belt deflection of 5 mm (0.2 in.) midway between the pulleys when applying a force of 20-30 N (4-6 lb.).

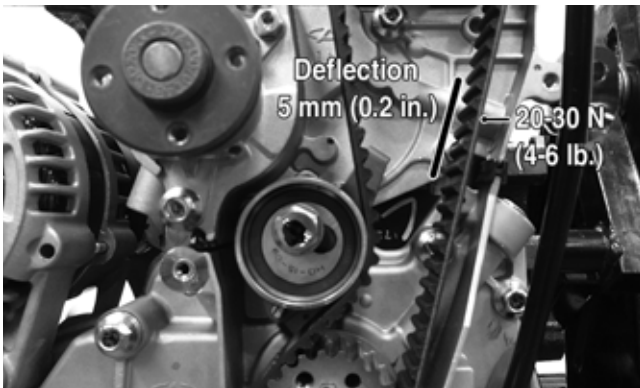

MF089B

11. Tighten the tensioner cap screw to 18.5 ft-lb (25 N-m).
12. Install the belt guide on the crankshaft; then install the lower and upper timing belt drive covers.

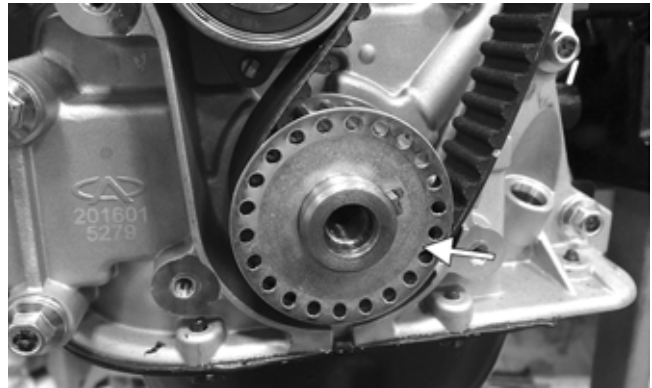

MF161A

13. Install the water pump pulley and tighten to 7.7 ft-lb (10 N-m); then install the crankshaft drive pulley; then tighten the crankshaft bolt to specifications.
14. Install the serpentine belt and tighten to specifications by prying the alternator in the direction of the arrow; then tighten the alternator mounting bolt (A) and adjuster cap screw (B) to specifications.

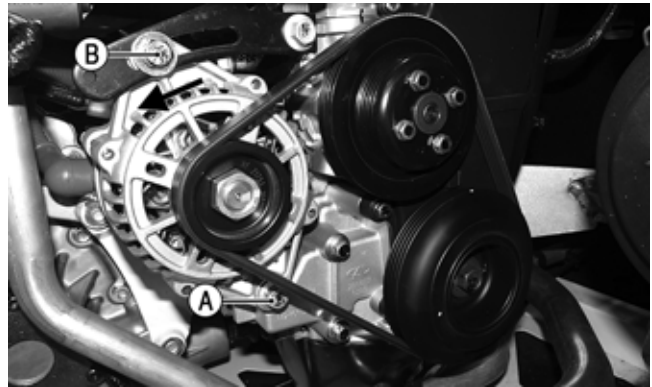

MF057C

15. Connect the negative battery cable to the negative post on the battery.

WATER PUMP

Removing

1. Remove the serpentine belt.
2. Drain the coolant (see Fuel/Lubrication/Cooling).
3. Remove the four cap screws securing the water pump pulley; then remove the water pump pulley; then remove the timing belt cover.

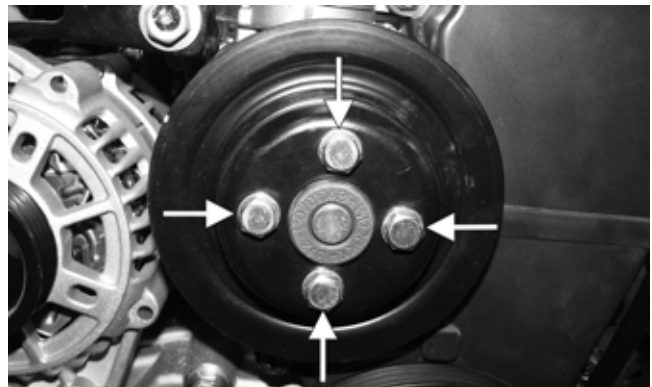

MOD589

4. Remove the three cap screws securing the water pump; then remove the water pump.

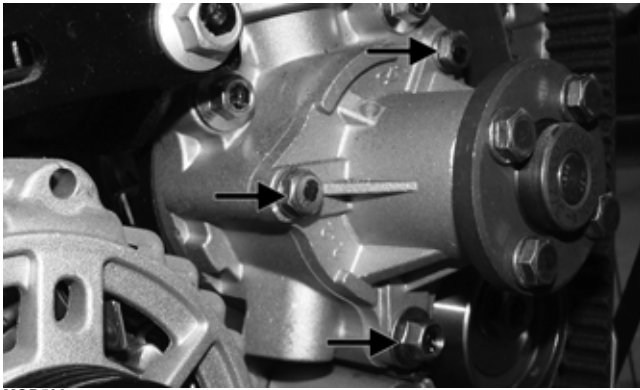

MOD590

5. Account for the water pump O-ring.

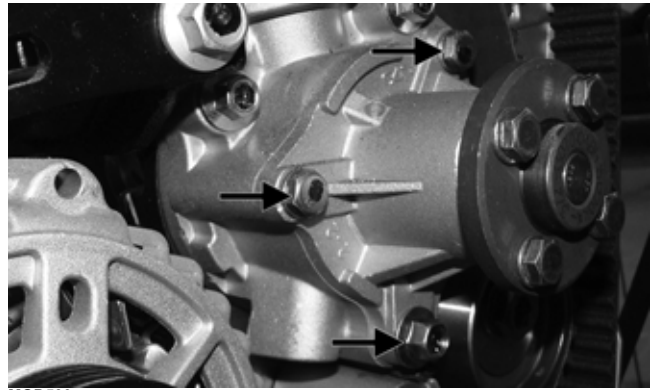

MOD590

3. Install the water pump pulley. Tighten to 5.9 ft-lb (8 N-m).

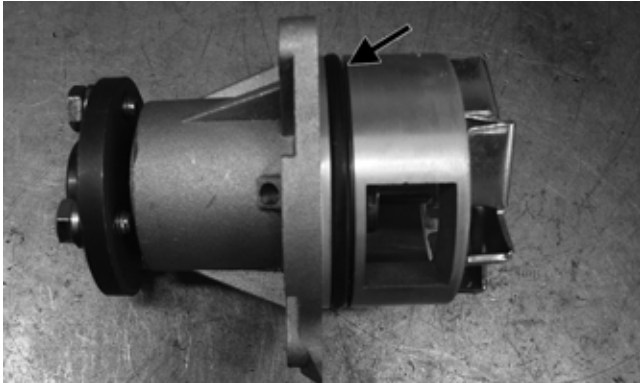

MOD591

Servicing

■NOTE: The water pump is only serviceable as an assembly.

Installing

1. Make sure all mating surfaces are free of any gasket material, sealant, or residue.
2. Using a new O-ring with a light film of petroleum jelly, install the water pump onto the engine and secure with the three cap screws. Tighten to 14.8 ft-lb (20 N-m).

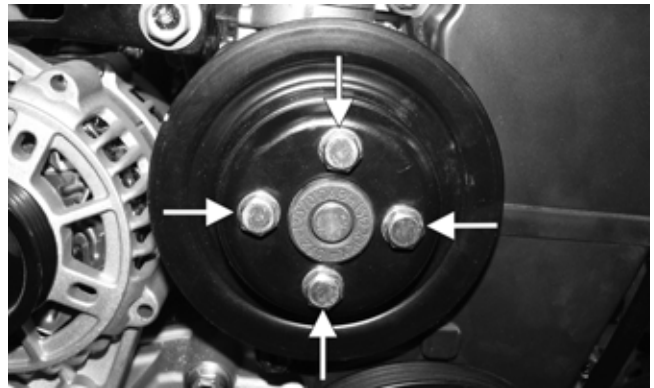

MOD589

4. Install the timing belt cover (see Removing Cylinder Head and Related Components in this section); then install the serpentine belt.
5. Fill the cooling system with coolant (see Fuel/Lubrication/Cooling); then bleed the system (see Bleeding Cooling System).
6. Check for coolant leaks and proper coolant level.

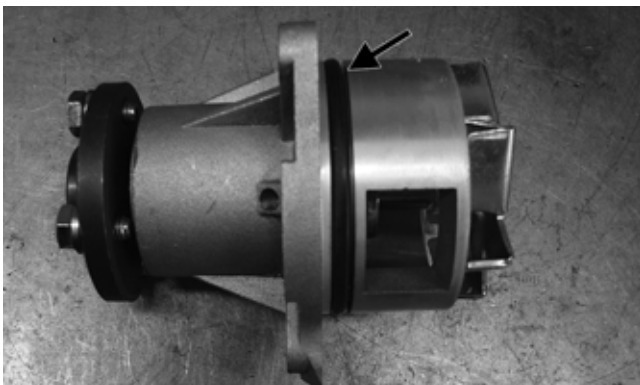

MOD591

ADJUSTING VALVE CLEARANCE

Shims

| Part Number | Thickness |
|-------------|-----------|
| 3040-157 | 2.06 mm |
| 3040-158 | 2.08 mm |
| 3040-159 | 2.10 mm |
| 3040-160 | 2.12 mm |
| 3040-161 | 2.14 mm |
| 3040-162 | 2.16 mm |
| 3040-163 | 2.18 mm |
| 3040-164 | 2.20 mm |
| 3040-165 | 2.22 mm |
| 3040-166 | 2.24 mm |
| 3040-167 | 2.26 mm |
| 3040-168 | 2.28 mm |
| 3040-169 | 2.30 mm |
| 3040-170 | 2.32 mm |
| 3040-171 | 2.34 mm |
| 3040-172 | 2.36 mm |
| 3040-173 | 2.38 mm |
| 3040-174 | 2.40 mm |
| 3040-175 | 2.42 mm |
| 3040-176 | 2.44 mm |
| 3040-177 | 2.46 mm |
| 3040-178 | 2.48 mm |
| 3040-179 | 2.50 mm |
| 3040-180 | 2.52 mm |
| 3040-181 | 2.54 mm |
| 3040-182 | 2.56 mm |
| 3040-183 | 2.58 mm |
| 3040-184 | 2.60 mm |
| 3040-185 | 2.62 mm |
| 3040-186 | 2.64 mm |
| 3040-187 | 2.66 mm |
| 3040-188 | 2.68 mm |
| 3040-189 | 2.70 mm |
| 3040-190 | 2.72 mm |
| 3040-191 | 2.74 mm |
| 3040-192 | 2.76 mm |
| 3040-193 | 2.78 mm |
| 3040-194 | 2.80 mm |

When servicing the valve assembly, inspect valve seats, valve stems, valve faces, and valve stem ends for pits, burn marks, or other signs of abnormal wear.

■NOTE: All valves can be adjusted using the following procedure with the exception of the intake and exhaust valves nearest the drive gears (see ALTER-NATE VALVE CLEARANCE ADJUSTMENT in this section).

1. To adjust valve clearance, rotate the engine in the direction of rotation until the camshaft lobe (A) high point is directly opposite the valve bucket (B) of the valve to be checked; then with a small pick or screwdriver, rotate the bucket until notch (C) is accessible.

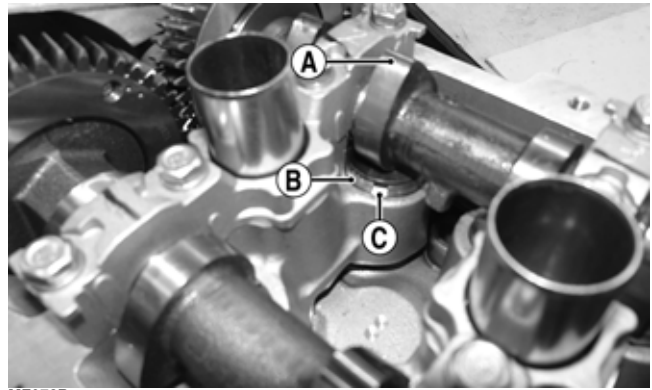

MF078B

Available Valve Clearance Adjustment Shims

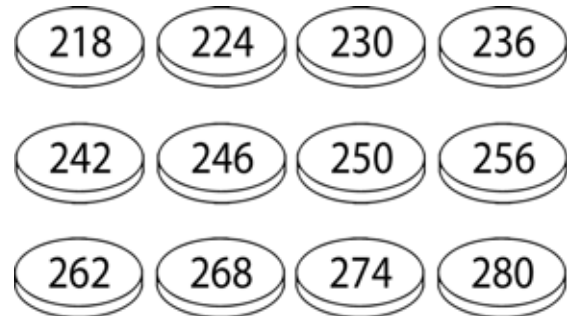

2. Turn the crankshaft in direction of rotation until high point (A) of the camshaft lobe of the valve to be adjusted points directly down toward the valve bucket (B), fully opening the valve; then insert the Valve Adjust Tool, in position between the camshaft and the valve bucket.

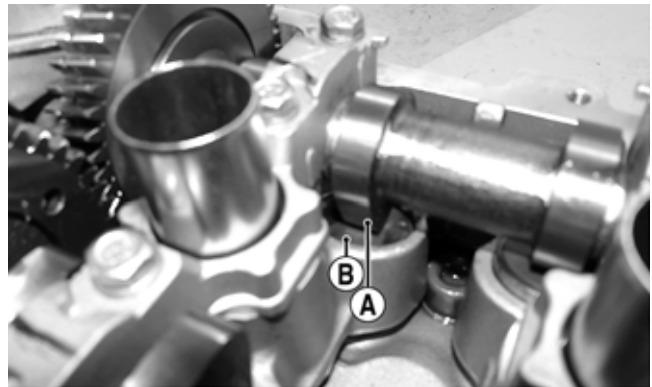

MF077A

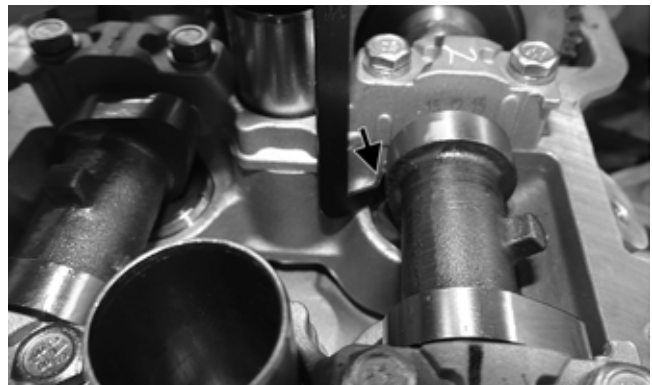

MF074A

3. Firmly holding the bucket retainer and rotate the crankshaft so as to position the camshaft lobe high point away from the valve bucket; then, using a small screwdriver and magnet, tip the valve adjustment shim up and out of the valve bucket.

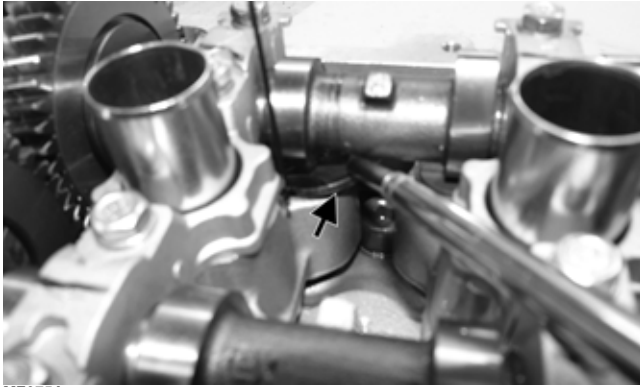

MF075A

4. Read the number on the valve side of the adjustment shim placing a decimal point after the first number.



MF076

5. Verify the printed number by checking the thickness with a micrometer or accurate calipers.

■NOTE: To increase valve clearance, decrease the shim thickness. To decrease valve clearance, increase the shim thickness.

Calculating Shim to Install

To calculate the desired shim to install, proceed as follows:

1. Add the thickness of the removed shim to the measured valve clearance; then subtract the desired valve clearance to find the shim value required.
2. Example: Measured valve clearance on an intake valve was 0.15 mm and the removed shim was 2.64 mm. Adding 0.15 mm to 2.64 mm, we get a value of 2.79 mm.

$$\begin{array}{c}
 \text{0.15 mm} \\
 + \quad \text{2.64 mm} \\
 \hline
 \text{2.79 mm}
 \end{array}$$

MF076B

3. Subtracting the desired intake valve clearance of 0.18 mm from 2.79 mm, will result in a shim value of 2.61 mm.

$$\begin{array}{c}
 \text{2.79 mm} \quad - \quad \text{0.18 mm} \\
 \hline
 \text{2.61 mm}
 \end{array}$$

MF076C

4. Choose the shim size closest to the calculated shim value — in this case, 2.62 mm (262).

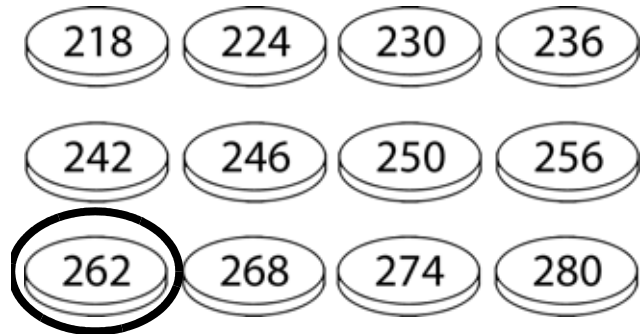

MF076D

5. Install the new shim with the number side down, making sure it is properly seated in the valve bucket; then rotate the crankshaft until the high point is directed downward toward the valve.

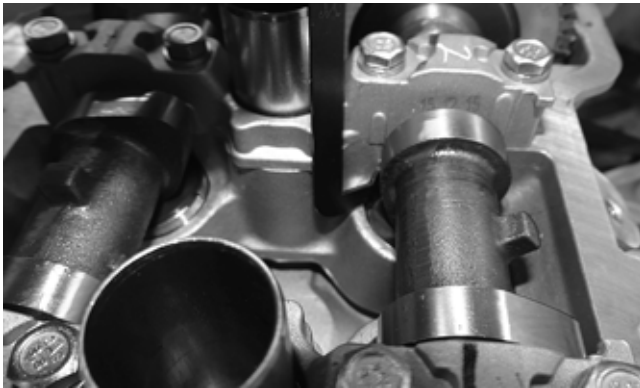

MF074

6. Remove the Valve Adjust Tool; then rotate the crankshaft through at least two revolutions, making sure the shim is adequately seated in the valve bucket.
7. Recheck the valve clearance on adjusted valves as prescribed in (see CHECKING VALVE CLEARANCE in this section).
8. Install the valve cover (see Installing Valve Cover in this section).

ALTERNATE VALVE CLEARANCE ADJUSTMENT

1. Remove the camshaft drive belt (see REMOVE AND INSTALL CAMSHAFT DRIVE BELT in this section).

■NOTE: Valve clearance must be measured and recorded prior to step 2.

2. Rotate the camshaft drive pulley until the camshafts “unload” (camshaft lobes relaxed from valve buckets).

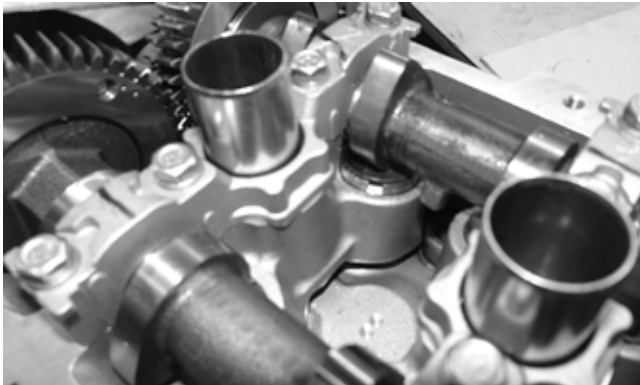

MF078

3. Remove the camshaft drive pulley; then remove the five cap screws securing the drive-end camshaft bearing housing and remove the housing.

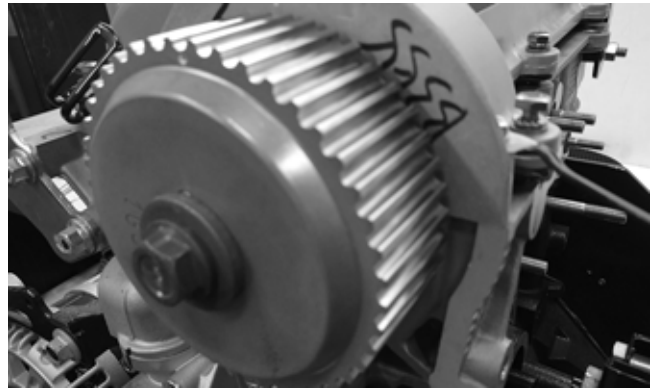

MF092

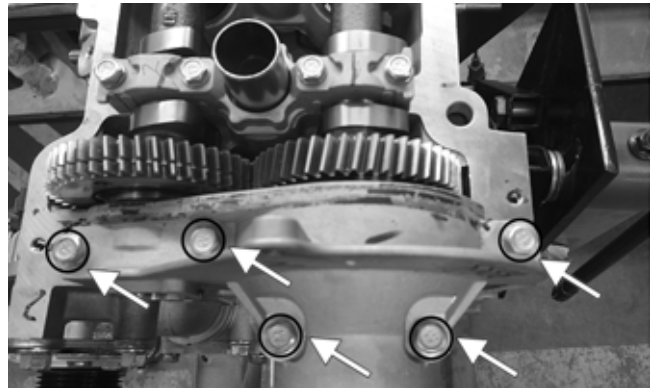

MF111A

4. Loosen but do not remove the cap screws securing the camshaft bearing housings to the cylinder head.

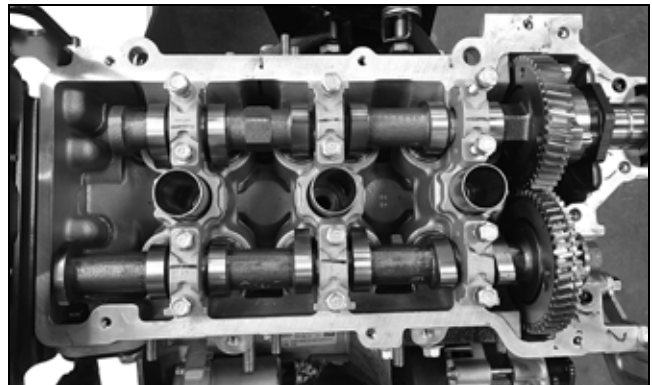

MF098

5. Use a sharp pick or small screwdriver to rotate the valve bucket until the notch is accessible; then lift the adjuster shim and remove using a small magnet or needle-nose pliers.



MF038A

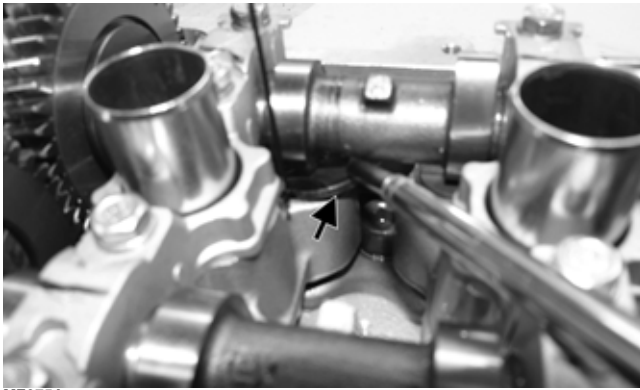

MF075A

6. Inspect shim for its size; then calculate which shim needs to be installed (see Calculating Shim to Install in this section).
7. Replace the removed shim(s) with the proper thickness shim as calculated; then tighten the camshaft bearing cap screws to specifications using the sequence shown making sure that camshaft gear timing marks are correctly aligned.

■NOTE: It is recommended that the cap screws be tightened in several increments to allow the camshafts to be evenly seated in the camshaft bearings.

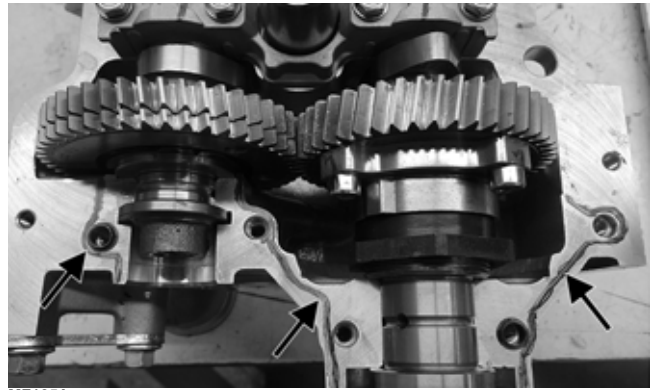

MF125A

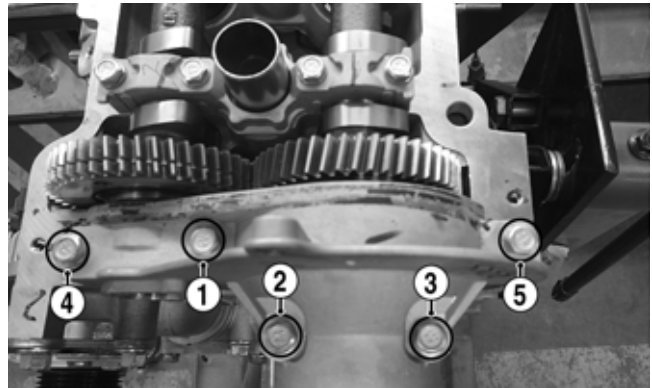

MF111B

9. Install the camshaft drive and driven pulleys.

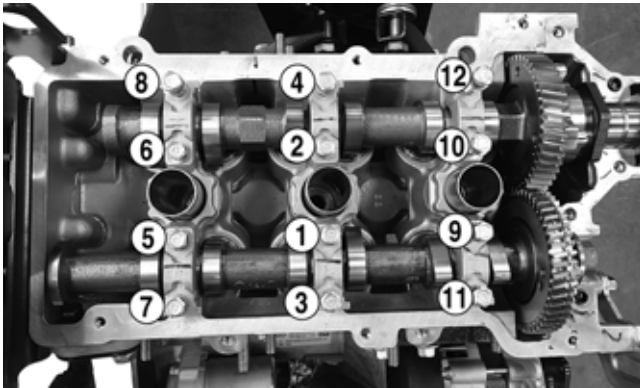

MF098B



MF093

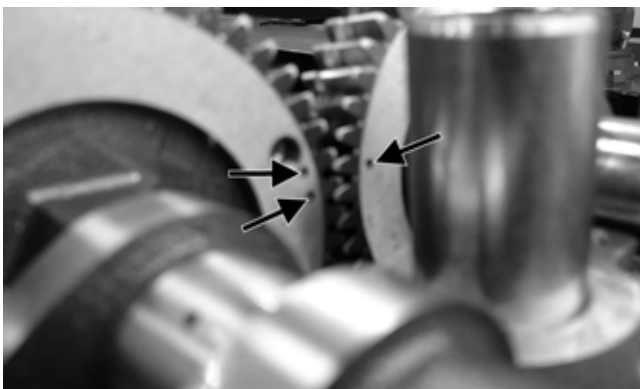

MF108A

8. Apply a thin bead of high temperature silicone sealant to the cylinder head as shown; then install the drive end camshaft bearing housing and tighten the five cap screws to specifications in the sequence shown.

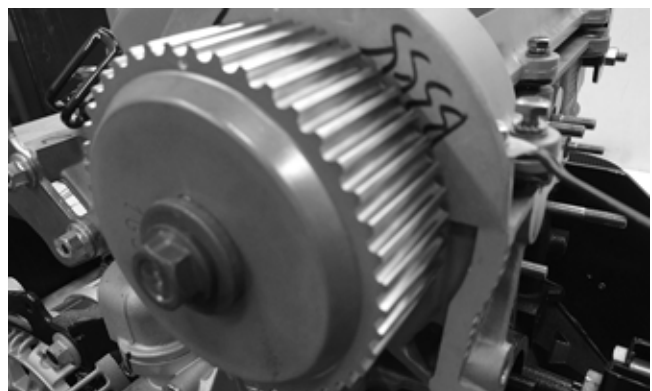

MF092

10. Tighten the camshaft drive pulley bolt to specifications; then install the camshaft drive belt making sure the camshafts are correctly timed to the crankshaft (see REMOVING AND INSTALLING CAMSHAFT DRIVE BELT in this section).

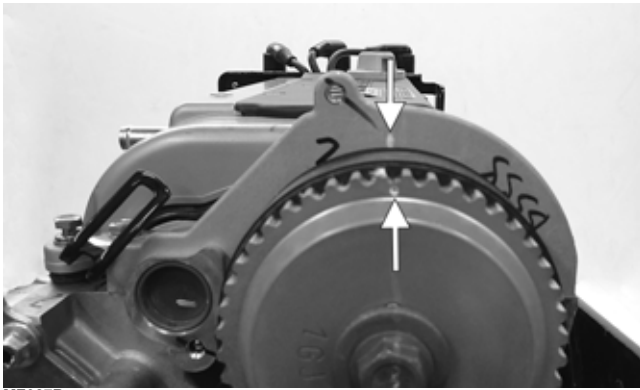

MF087B

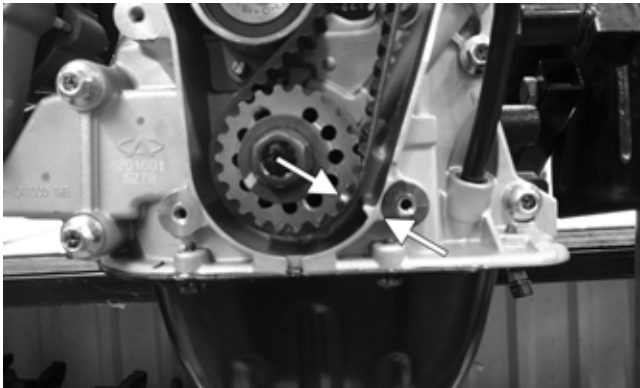

MF088B

11. Install the camshaft drive belt guide with the tapered circumference directed away from the drive pulley.



MF161A

12. Install the upper and lower drive belt covers (E) and tighten the cap screws securely.

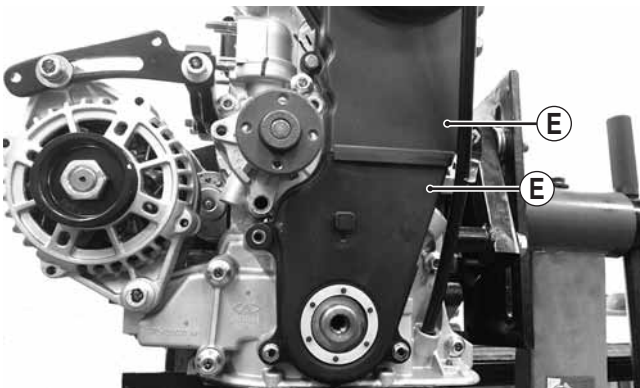

MF084A

13. Install the water pump drive pulley (C) and crankshaft drive pulley (D) and tighten the water pump pulley cap screws and crankshaft drive pulley bolt to specifications.

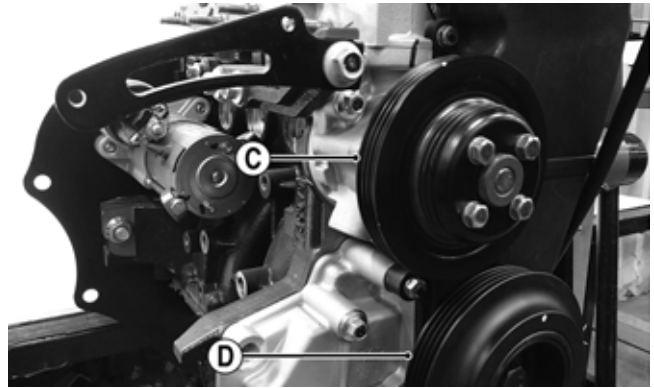

MF081A

14. Install the serpentine belt and tighten as required.

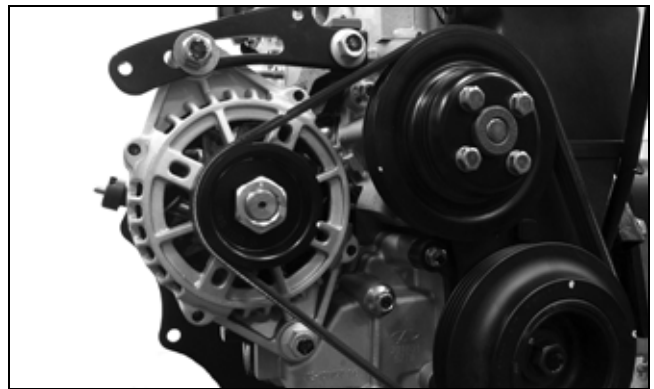

MF079

15. Install the valve cover and tighten to specifications.

REMOVING AND INSTALLING CAMSHAFTS/VALVE BUCKETS

■NOTE: The engine does not need to be removed from the vehicle for this procedure.

1. Disconnect the negative battery cable from the battery; then remove the camshaft drive belt (see REMOVING AND INSTALLING CAMSHAFT DRIVE BELT in this section).
2. Remove valve cover (see Removing Valve Cover in this section).
3. Remove five cap screws securing the drive end camshaft housing and remove the housing.

■NOTE: The cap screws are different lengths and must go back to their respective place.

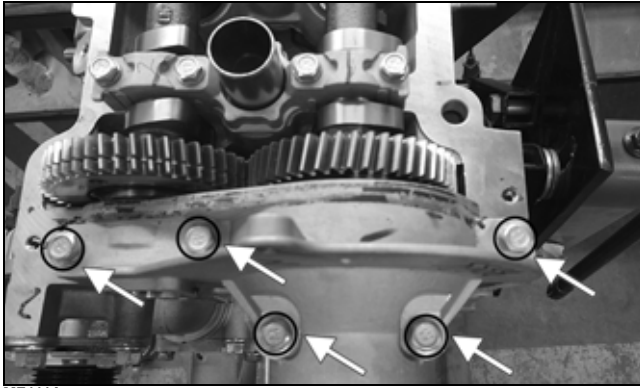

MF111A

4. Install a 5 mm x 80 cap screw in the hole next to the pinned hole on the intake camshaft drive gear and tighten to secure the master and slave gears in position; then rotate the camshafts to relieve the valve spring pressure (approximately 1/3 turn).

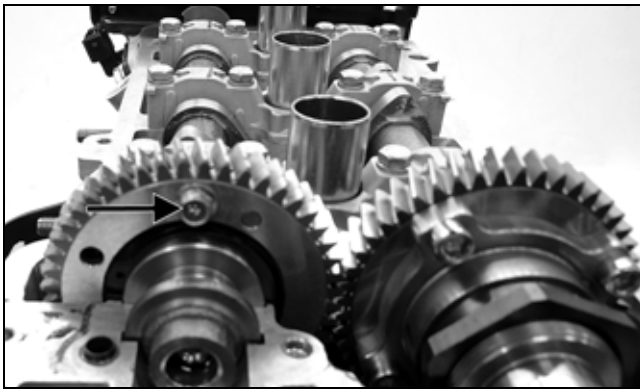

MF097A

CAUTION

It is absolutely imperative to mark and note the positions and orientation of all valve train components for proper installation when installing. Failure to do this may result in accelerated component wear and complete valve train adjustment. Adjacent moving components wear against each other taking a "set." Mismatching of adjacent wear parts will result in excessive wear and, in the case of bearing caps, total component failure.

5. Loosen the cap screws securing the camshaft bearing caps to the cylinder head in the sequence shown to allow the camshafts to unload evenly; then remove the bearing caps noting their position and numbers inscribed on the caps.

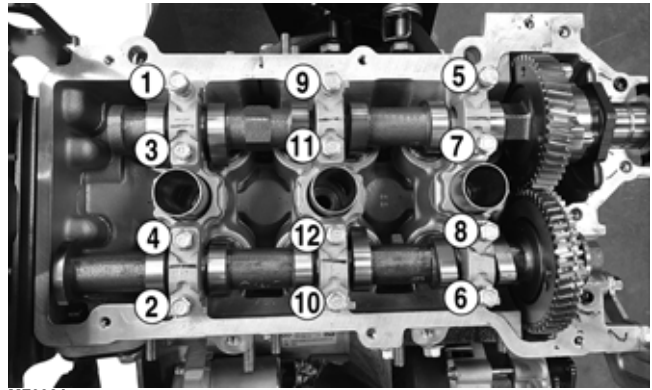

MF098A



MF099

■NOTE: The numbers represent the position and the arrows should be directed toward the drive end of the camshafts.

■NOTE: Expect the camshafts to rise up as the compressed valve springs "unload" upon bearing cap removal.

CAUTION

The camshaft bearing caps MUST be returned to their original position and orientation or severe engine damage will occur!

6. Remove the end plug from the intake camshaft and the oil seal from the drive end of the exhaust camshaft.



MF096B

7. Make sure the cap screw from step 4 is properly installed; then carefully lift the camshafts from their respective journals using caution not to lift unevenly causing binding or galling of the camshaft bearing surfaces.

■NOTE: It is recommended to loosely install the camshaft bearing caps in their original positions to prevent mixing up while performing other related operations.

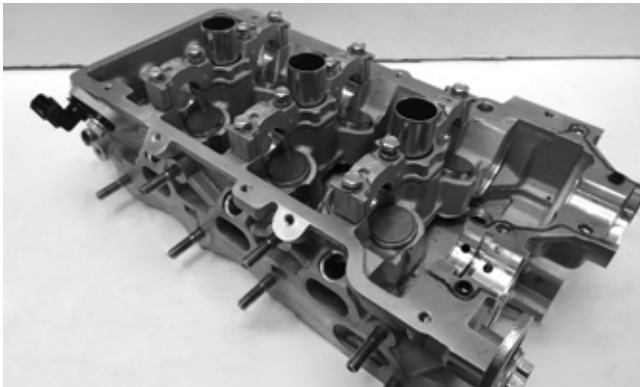

MF160

8. Inspect the camshaft bearing surfaces in the cylinder head and the bearing caps for signs of scoring, galling, or heat damage. If damaged, the engine must be replaced.



MF099

9. Inspect the camshaft bearing journals and caps for scoring, flaking, galling, or signs of heat damage. If damage is present, the cylinder head will have to be replaced (see REMOVING AND INSTALLING CYLINDER HEAD in this section).

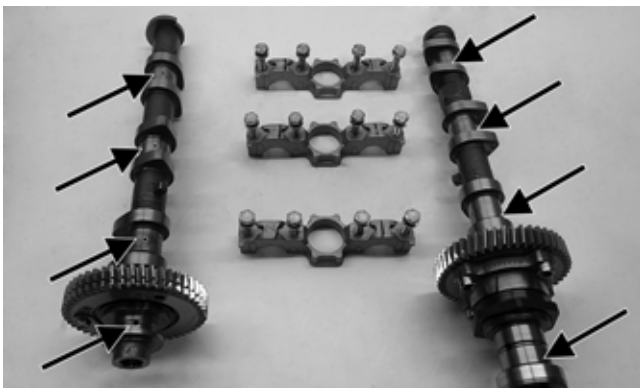

MF100A

10. Inspect the camshaft lobes for flaking, galling, scoring, or bluing indicating heat build-up. If damaged or worn beyond limits, camshafts will have to be replaced.

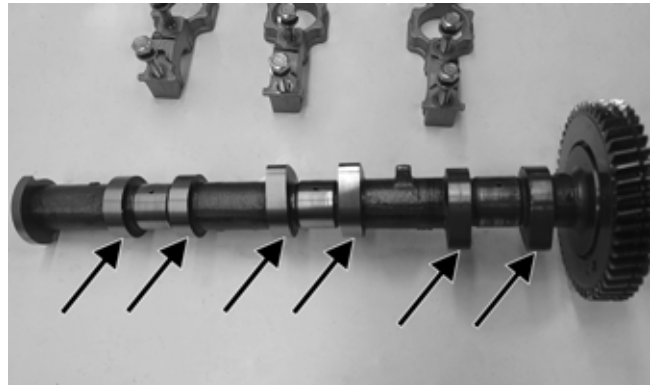

MF101A

11. Inspect the camshaft drive gears for excessive wear, chipped or missing teeth, and security to the camshafts. Replace as required.

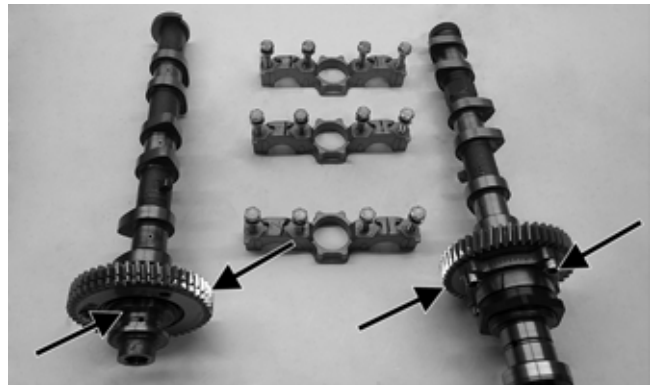

MF100B

12. Inspect the valve buckets and adjustment shims for scoring, flaking, excessive wear, or discoloration. Replace as required.

■NOTE: When removing, make sure to mark locations and orientation of valve buckets related to position in the cylinder head keeping buckets and their respective shims together.

13. Install valve buckets and shims in locations as marked during disassembly and inspection.

■NOTE: If parts are mixed up or replaced, it will be necessary to perform valve clearance checks and adjustments as required for any replaced and adjacent components.

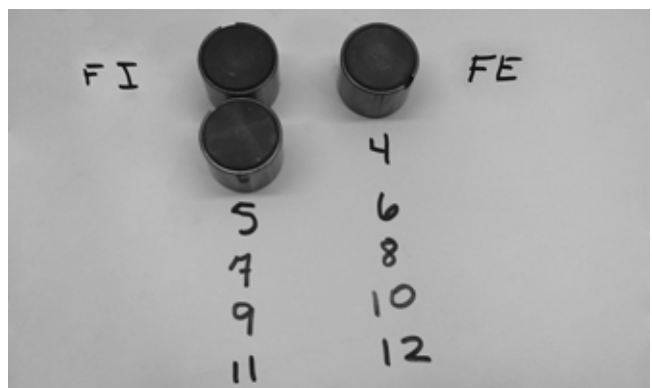

MF107

14. Install the camshaft drive seal; then install camshafts aligning timing punch marks as shown.



MF126A

15. Install the camshaft bearing caps in their proper location and orientation: then secure with the cap screws tightened to specifications in the sequence shown.

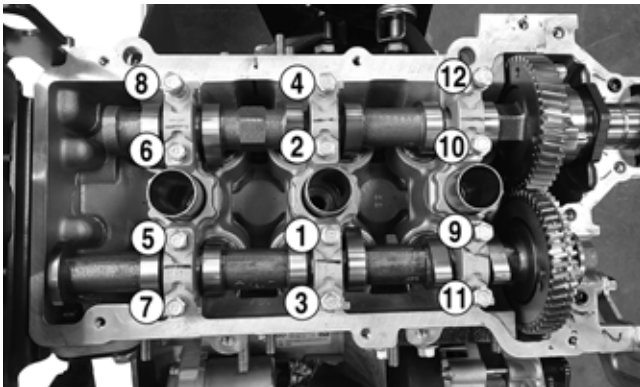

MF101B

■ **NOTE** It is recommended that the cap screws be tightened in several increments to allow the camshafts to be evenly seated in the camshaft bearings.

16. Remove the 5 mm cap screw from the intake camshaft drive gear and recheck the punch marks to verify that the camshafts are correctly timed to each other; then apply a thin bead of high temperature silicone sealant to the cylinder head as shown.



MF126A

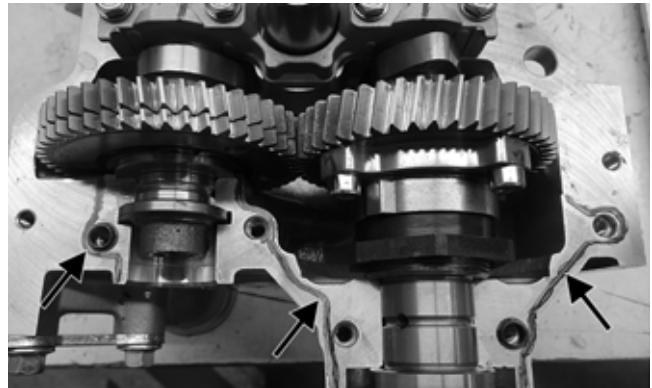

MF125A

CAUTION

Failure to remove the 5 mm cap screw prior to turning the engine will result in damage to the cylinder head. It is a good practice to manually rotate any engine components after installation and torquing.

17. Install the camshaft drive end bearing cap, and camshaft end plug; then install the five cap screws and tighten to specifications in the sequence shown.

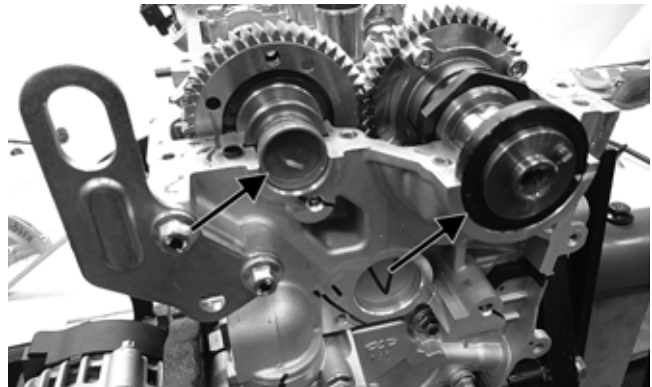

MF096B

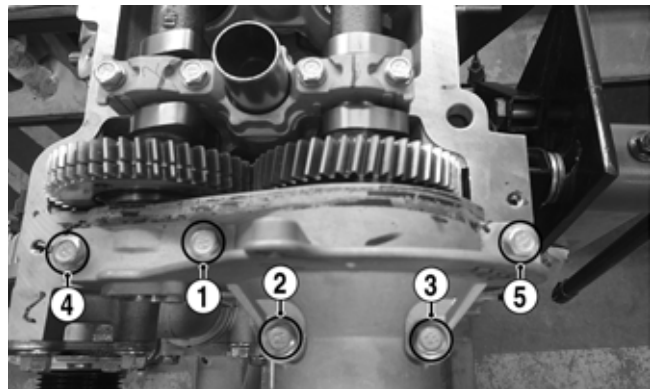

MF111B

18. Install the camshaft drive belt and covers making certain that the camshafts are correctly timed to the crankshaft (see REMOVING AND INSTALLING CAMSHAFT DRIVE BELT in this section).

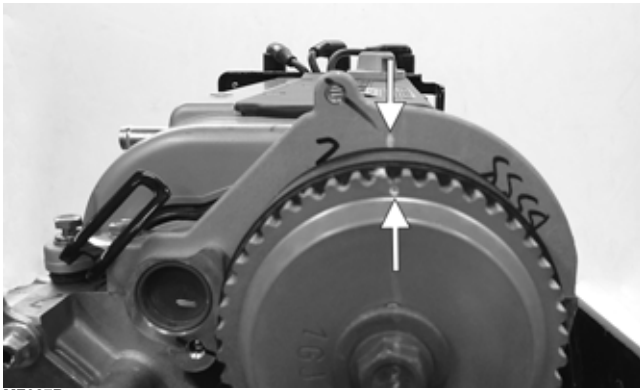

MF087B

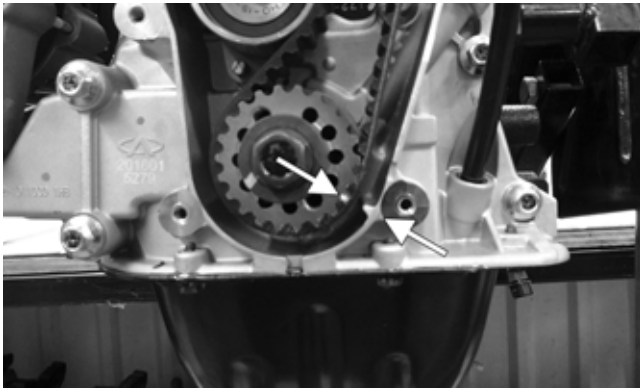

MF088B

19. Using a new valve cover gasket, install the valve cover and tighten to specifications.
20. Install spark plugs and torque to specifications; then install spark plug wires, breather hose, and oil fill plug.
21. Move the vehicle to an open/well ventilated area, and run until warmed up (coolant fan cycling) and check for leaks.

REMOVING, SERVICING, AND INSTALLING CYLINDER HEAD

■NOTE: The engine does not need to be removed from the vehicle for this procedure.

1. Tilt the cargo box up.
2. Remove the driver and passenger rear inner fenders.
3. Disconnect the negative battery cable.
4. Remove the coolant cap; then drain coolant.
5. Disconnect the coolant hose (2) and the coolant bypass tube (3) from the thermostat housing.

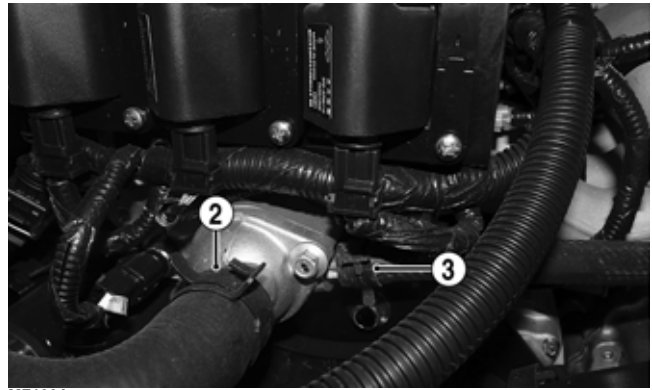

MF133A

6. Remove the cap screws securing the exhaust pipe to the exhaust manifold and separate the exhaust pipe from the manifold. Account for the gasket.

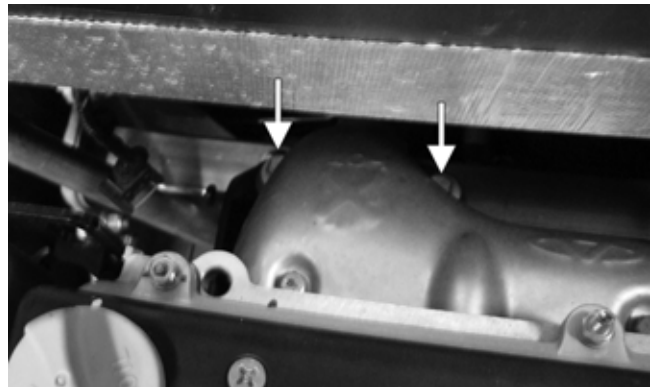

MOD549

7. Disconnect the fuel hose connector from the fuel rail; then remove the P-clamp holding the fuel line to the intake manifold.

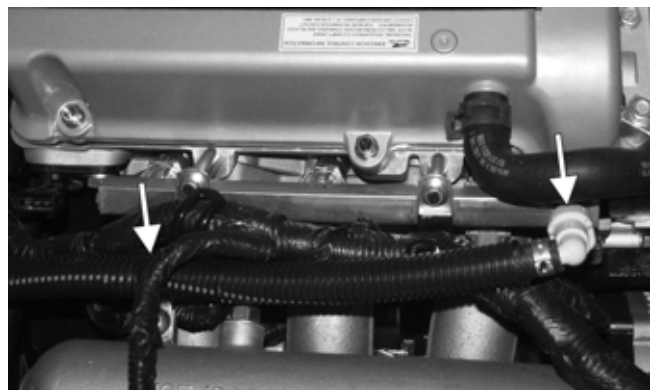

MOD602

⚠ WARNING

Fuel may be under pressure. Wrap a cloth around the connector when disconnecting to prevent gasoline from spraying out and creating a fire hazard. Always wear safety glasses to prevent personal injury when disconnecting any fluid lines.

8. Disconnect the coolant temperature sensor wire from the coolant sensor (4); then mark the location of the coil pack connectors to the coil pack; then disconnect the coil pack connectors; then mark the location of the spark plug wires to coil packs; then remove spark plug wires; then remove the two cap screws and lock nut securing the coil packs to the cylinder head and remove coil packs. Discard lock nuts. Inspect cap screws and replace if damaged.

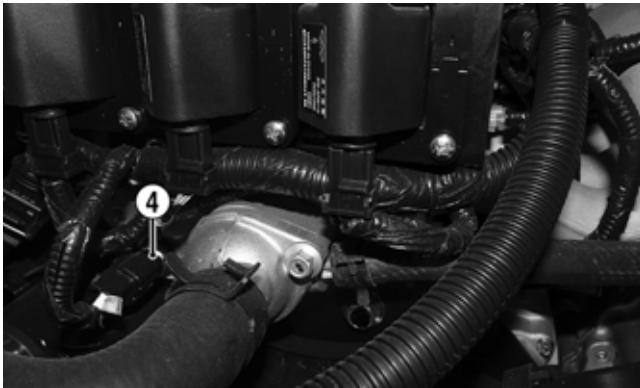

MF133B



MF019A

9. Disconnect the air inlet tube from the intake manifold; then disconnect the throttle body (TB) connector (6).

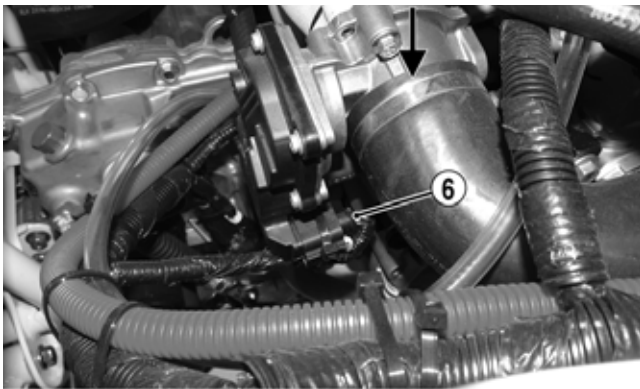

MF134A

10. Disconnect the three fuel injector connectors (7); then disconnect the temperature/manifold absolute pressure (TMAP) connector (5).

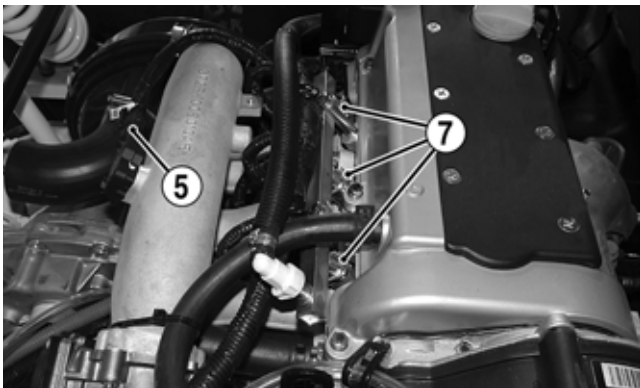

MF144A

11. Remove the camshaft drive belt (see REMOVING AND INSTALLING CAMSHAFT DRIVE BELT in this section).
12. Remove camshafts (see REMOVING AND INSTALLING CAMSHAFTS in this section).
13. Remove the eight head bolts securing the cylinder head to the cylinder block in the sequence shown. Account for the hardened washers on each head bolt.

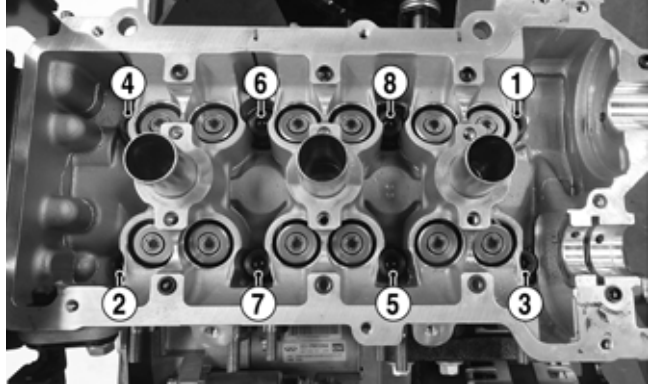

MF113B

14. Carefully lift the cylinder head from the cylinder block. Account for and note the orientation of the head gasket (8) relative to the oil supply port (9) and a formed weather seal (10).

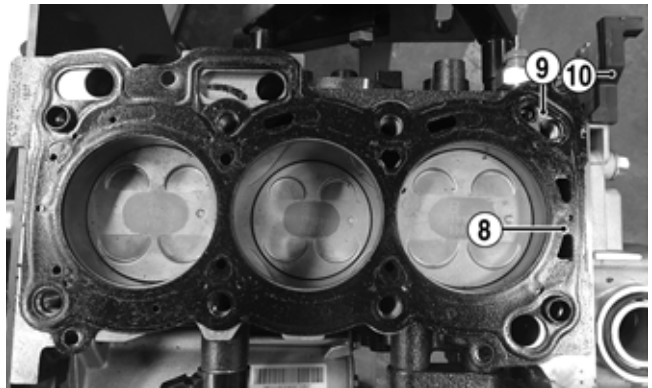

MF140A

15. Remove and discard the coolant O-ring (11).

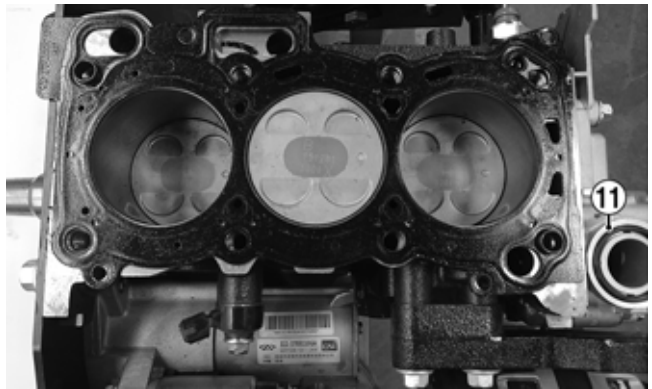

MF123C

16. Remove the heat shield from the exhaust manifold; then remove the manifold from the cylinder head.

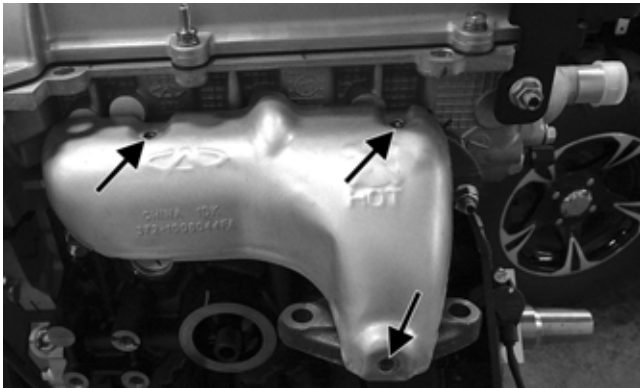

MF029A

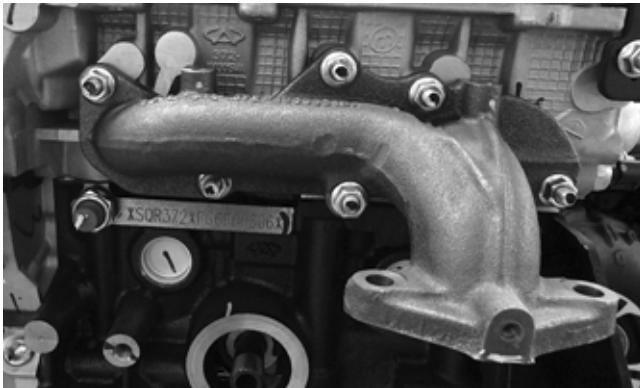

MF030

17. Remove the intake manifold from the cylinder head.

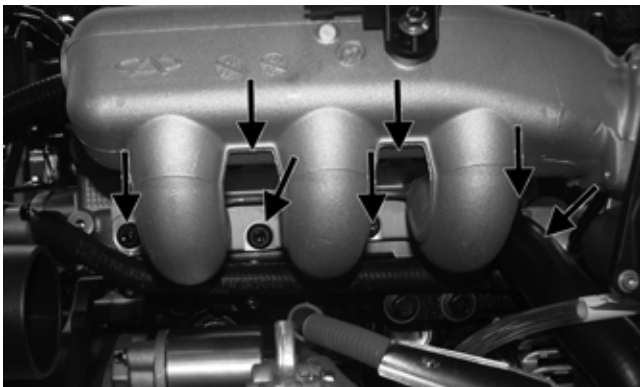

MOD603

INSPECTING AND SERVICING CYLINDER HEAD

■NOTE: It is recommended that all cylinder head repairs including valve grinding, seat replacement/surfacing, valve guide replacement, and surface plane procedures be accomplished by a qualified machine shop equipped to service aluminum cylinder heads.

1. Using a suitable straight edge and feeler gauge, check the cylinder head surface for flatness as shown. If measurement is greater than 0.08 mm (0.003 in.), the cylinder head must be resurfaced or replaced.
2. Being careful not to scratch or gouge the aluminum head, use a suitable soft wire brush to clean carbon deposits from combustion chambers and from around valve heads.

3. Use a suitable valve spring compressor, compress the valve spring (A); then depress the sleeve (B) to release the collets (C).

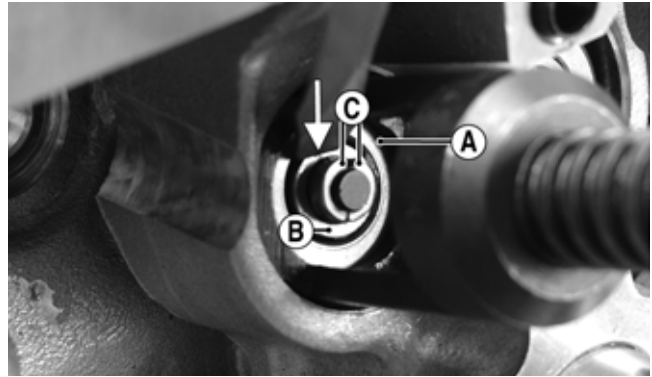

MF164A

4. Remove the collets (C) from the valve stem; then release the spring compressor and account for valve spring (A), sleeve (B), valve spring retainer (D), valve stem seal (E), valve spring seat washer (F), and valve (G).

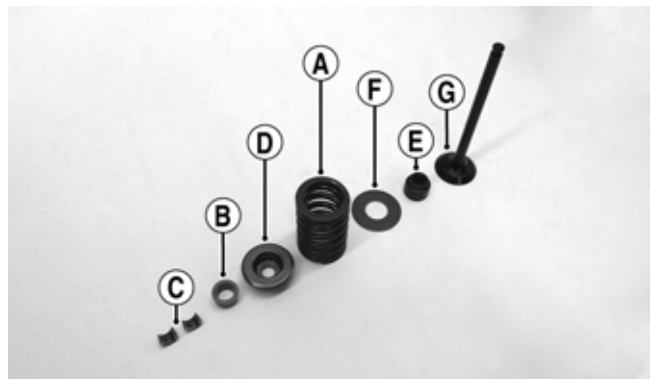

MF148A

■NOTE: Always mark or index all cylinder head components as to the location they were removed from. Failure to do so could result in unnecessary adjustments or accelerated wear due to mismatched wear surfaces.

5. Inspect valve seats for cracks, burn tracks, pitting, and security in head.
6. Using a micrometer, check the valve stem diameter; then check valve heads for excessive wear, discoloration, burning, or warpage.

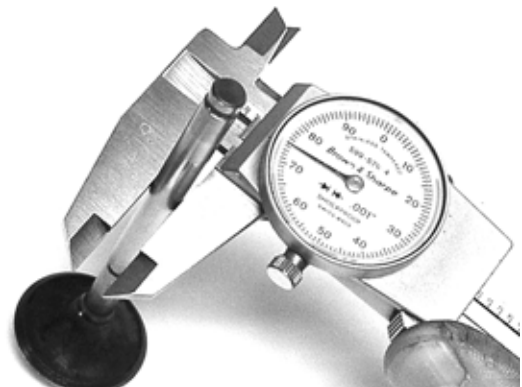

DE319

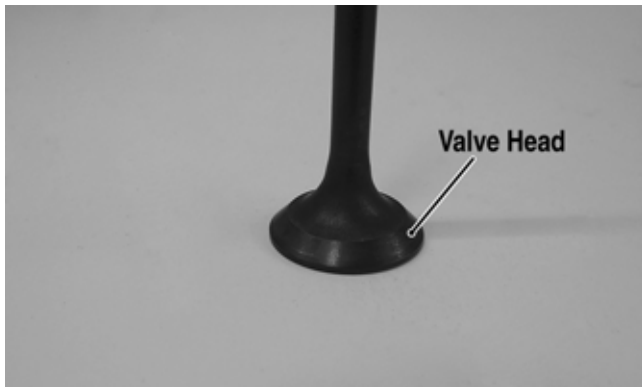

DE165A

7. Inspect valve springs and check for correct valve spring length, spring inclination, or breakage.

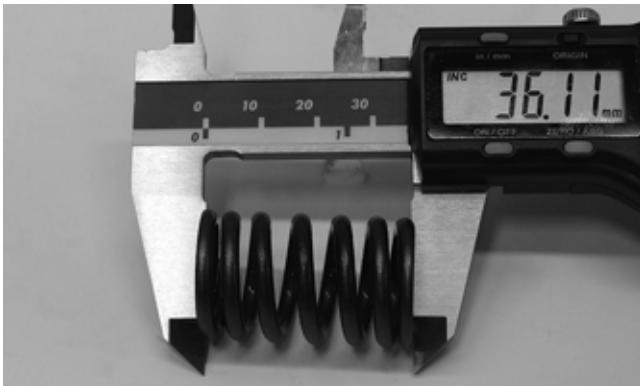

MF156

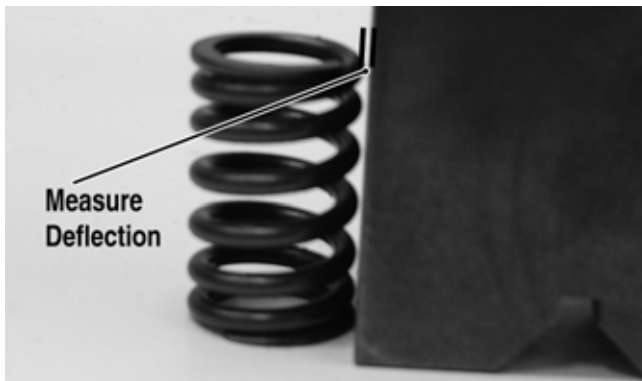

MF157A

8. Apply a small amount of lapping compound to the face of the valve (G) and using an appropriate lapping tool, lap the valve until a uniform ring (H) appears around the surface of the valve face (I).

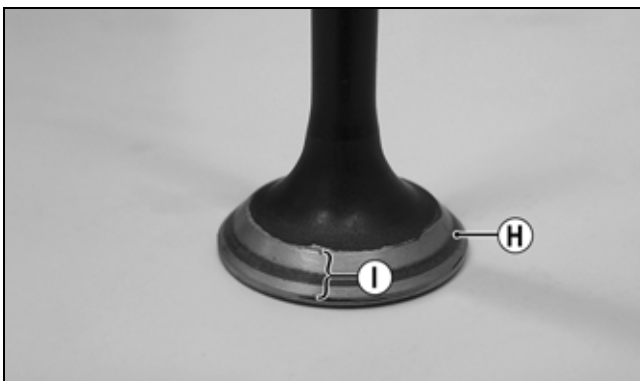

MF151A

9. Wash all parts in cleaning solvent to remove lapping compound and dry with compressed air.

10. Note the position of the lap ring on the face of the valve. The lap ring (H) should be at or very near the center of the valve face (I). If not within suitable tolerance, valves and seats must be replaced.

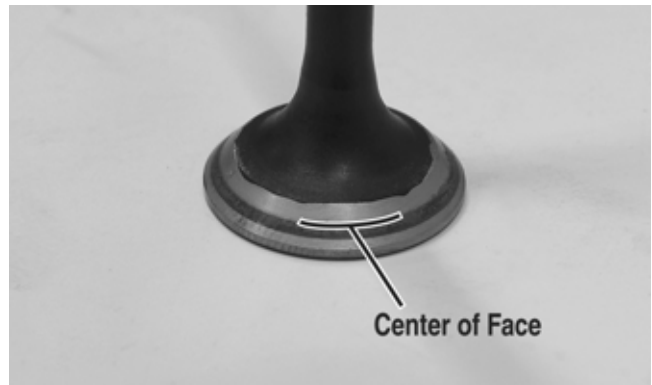

MF150A

11. Place the valve spring seat washer (F) in place and using a suitable installation tool, install a new valve stem seal (E) on the valve guide; then apply a coat of light assembly oil on the valve stems and install valve into the cylinder head.

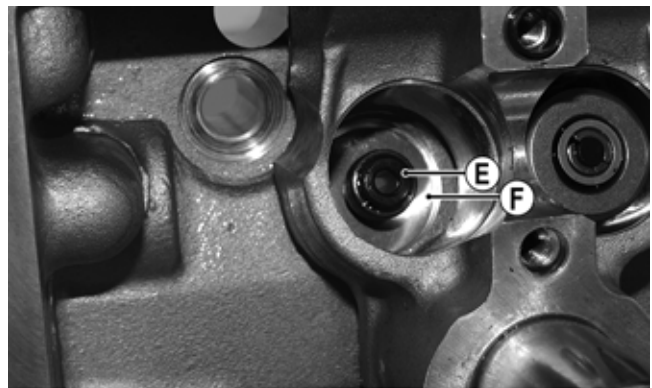

MF153A

12. Place the valve spring (A), valve spring retainer (D), and sleeve (B) into position and compress the assembly sufficiently to install the collets (C); then release the valve spring compressor tool, making sure the collets are fully seated in the sleeve.

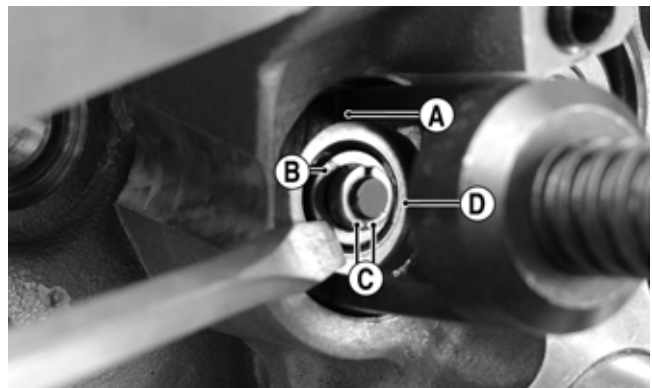

MF163A

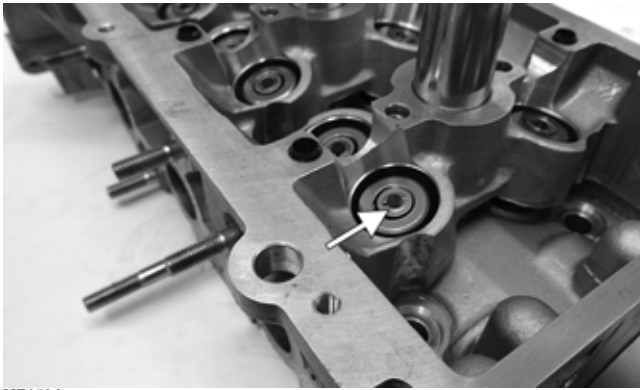

MF159A

■NOTE: Collets can be held in position during assembly by applying a small amount of grease to the inner surface of the collets.

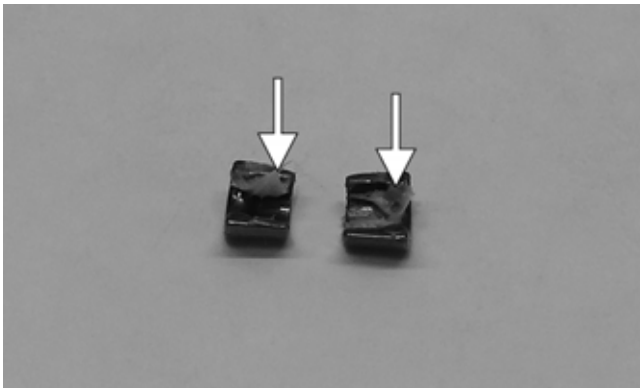

MF158A

INSTALLING CYLINDER HEAD

To install the cylinder head, use the following procedure:

■NOTE: Whenever a major engine component is removed for inspection or service, new gaskets, seals, and O-rings must be installed. Never attempt to reuse gaskets or seals.

1. Thoroughly clean all mating surfaces of the cylinder head and engine block as well as mating surfaces of any removed components.

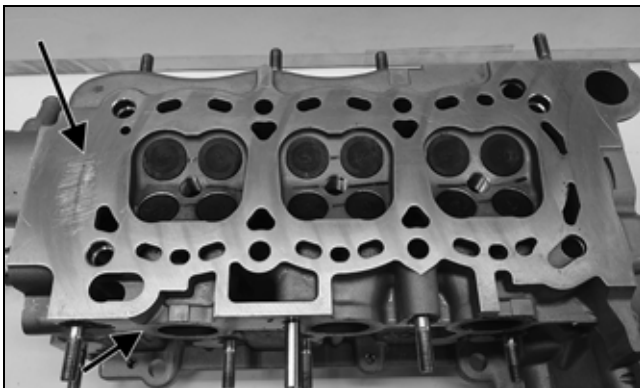

MF166A

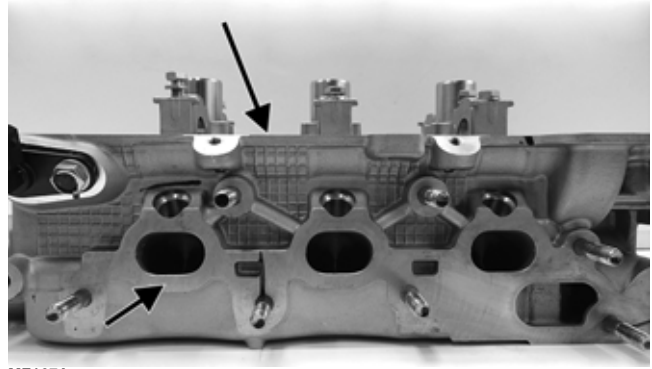

MF167A

2. If intake and exhaust manifolds were removed, using new gaskets, install and secure with attaching nuts (seven intake and six exhaust) and tighten to specifications. Install the heat shield onto the exhaust manifold.
3. Wipe all surfaces clean of lint, liquids, or other contaminants and place a new cylinder head gasket in place, making sure that the oil passage in the gasket (8) is properly aligned with the oil port (9) in the engine block; then install a new O-ring (11) and weather seal (10).

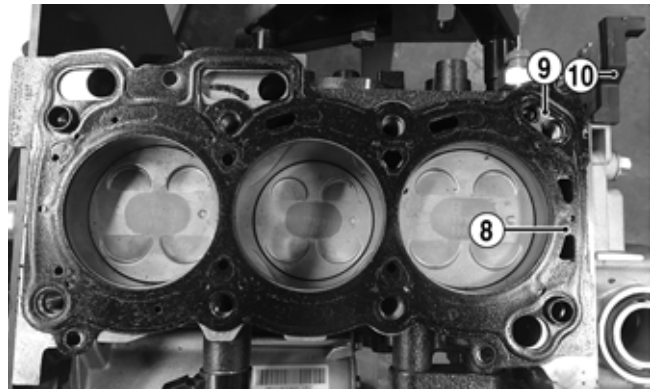

MF140A

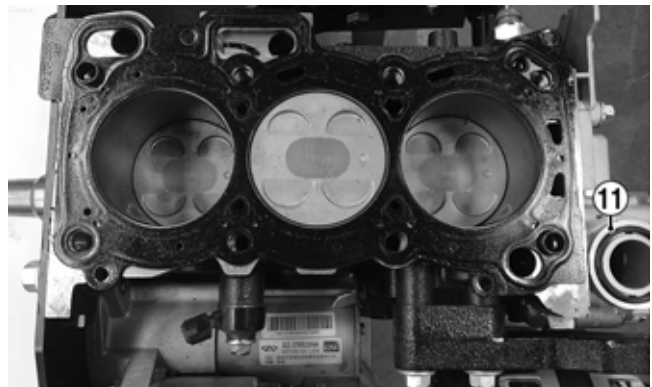

MF123C

CAUTION

To avoid severe engine damage, make sure that the oil passage in gasket (8) is properly aligned with the oil port (9) in the engine block.

- Carefully set the cylinder head onto the engine block making sure it seats properly on the alignment pins; then install the eight cylinder head bolts and using the sequence shown, tighten to specifications in the following three steps:

1st pass to 30 N-m (22 ft-lb)

2nd pass to 50 N-m (37 ft-lb)

3rd pass to 70 N-m (51 ft-lb)

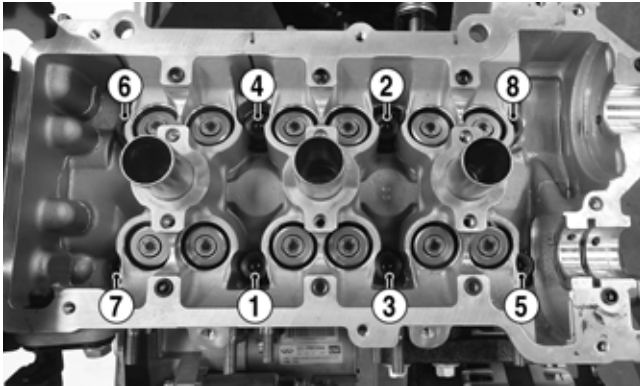

CD466

- Install the valve buckets with shims in the locations from which they were previously removed; then install the camshafts (see REMOVING AND INSTALLING CAMSHAFTS/VALVE BUCKETS in this section).

NOTE: It is highly recommended to check valve clearance on all valves after disassembly; however, if any valves or valve seats were replaced or ground, valve clearance **MUST** be checked on the appropriate valves and adjusted as specified (see ADJUSTING VALVE CLEARANCE in this section).

- Install the camshaft drive belt and covers (see REMOVING AND INSTALLING CAMSHAFT DRIVE BELT in this section).
- Connect the exhaust pipe to the exhaust manifold and secure with the cap screws and nuts tightened securely.

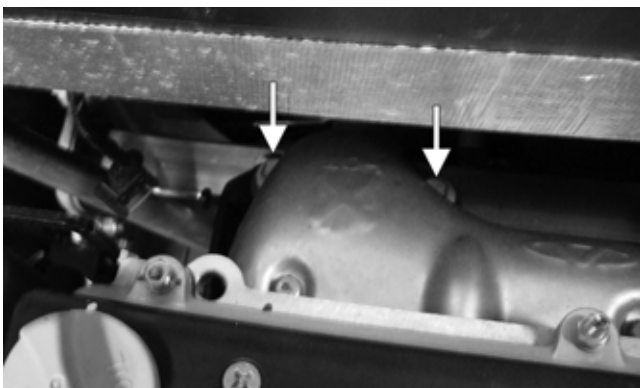

MOD549

- Install the fuel rail and injectors and secure with the two cap screws. Tighten to specifications.



MF135A

- Install the air inlet tube to the throttle body and tighten the clamp securely; then insert the throttle control connector (6) into the receptacle in the throttle body and seat securely.

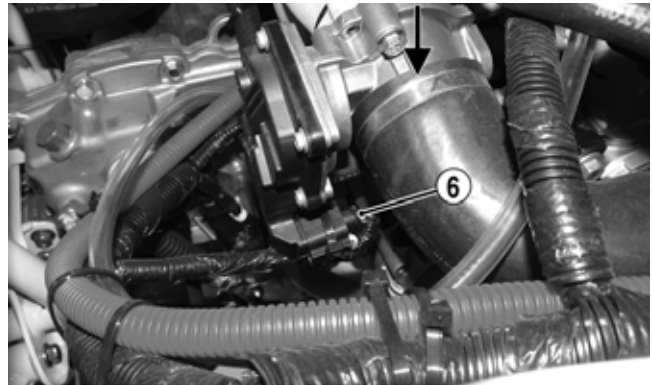

MF134A

- Connect the three fuel injector connectors (7) to the fuel injectors; then connect the IAT/MAP connector (5) to the sensor on the manifold.

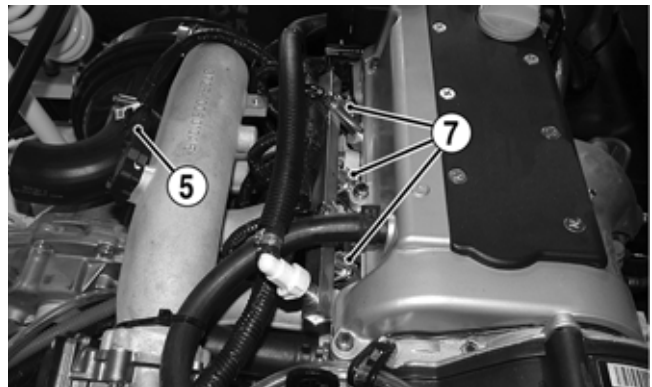

MF144A

- Install the fuel hose connector onto the fuel rail; then install the P-clamp holding the fuel line to the intake manifold; then install the coil pack onto the cylinder head and secure with the two cap screws and new lock nut. Tighten securely.



MOD602



MF019A

12. Connect the coolant temperature connector (4) to the coolant temperature sensor.

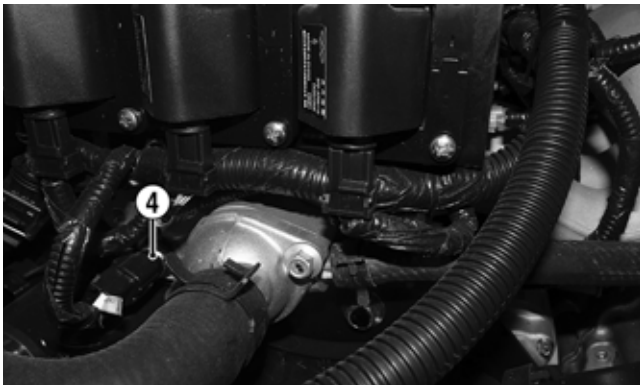

MF133B

13. Install the coolant bypass hose (3) and the coolant hose (2) onto the thermostat housing. Tighten the clamps securely.

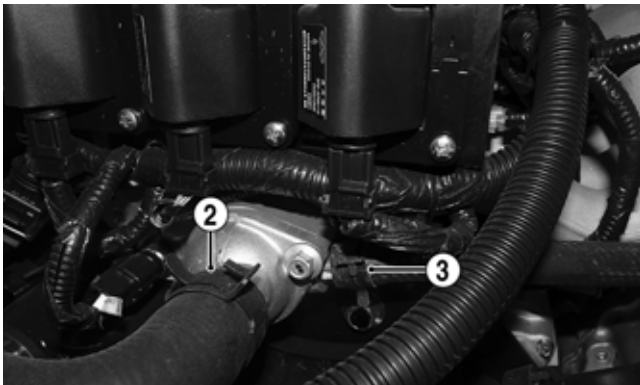

MF133A

14. Fill the cooling system with the appropriate quantity and mixture of coolant and install the coolant cap; then bleed the cooling system
15. Install the driver- and passenger-side rear inner fenders.

Servicing Left-Side Components

■NOTE: For efficiency, it is preferable to remove and disassemble only those components which need to be addressed and to service only those components. The technician should use discretion and sound judgment.

AT THIS POINT

To service any one specific component, only limited disassembly of components may be necessary. Note the AT THIS POINT information in each sub-section.

■NOTE: The engine does not have to be removed from the frame for this procedure.

AT THIS POINT

If the technician's objective is to service/inspect the drive belt, drive belt cover, driven pulley, or drive clutch, see Periodic Maintenance/Tune-Up.

CLUTCHES

Removing

1. Tilt the cargo box up.
2. Remove the driver-side rear inner fender by rotating the 1/4-turn fasteners counterclockwise.



MOD606

3. Loosen the clamp that holds the snorkel portion to the air inlet; then disconnect snorkel portion from air inlet.



MOD205A

4. Remove the six clamps securing the clutch cover; then remove clutch cover.

■NOTE: Firmly grasp clamps as they can completely detach from clutch cover assembly and spring away.



MOD533

5. Using the Drive and Driven Clutch Holder Tool to hold the driven clutch remove the cap screw securing the driven clutch.



MOD599

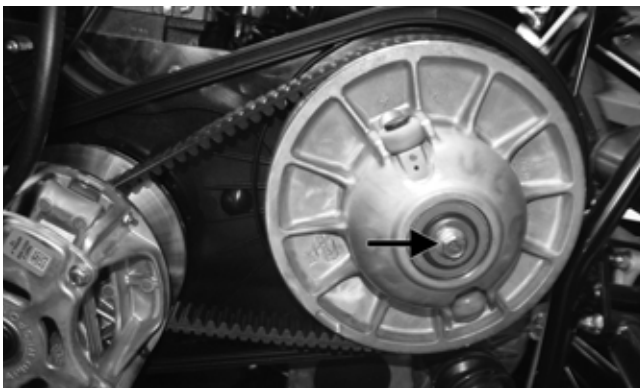

MOD213

6. Remove the belt by pulling it over the driven clutch and rotating the driven clutch.



MOD215

7. With the driven clutch still on the transaxle input shaft, place the Drive and Driven Clutch Holder Tool on the drive and driven clutch to hold the drive clutch in place; then with a Torx T-60 drive, remove the cap screw securing the drive clutch. Account for the washer.



MOD390

8. Lightly coat the threads and the end of the Drive Clutch Puller Tool with grease. Insert the Drive Clutch Puller Tool into the drive clutch. Tighten the Drive Clutch Puller Tool to remove the drive clutch.

■NOTE: It may be necessary to strike the end of the Drive Clutch Puller Tool with a hammer to remove the drive clutch from the PTO shaft.

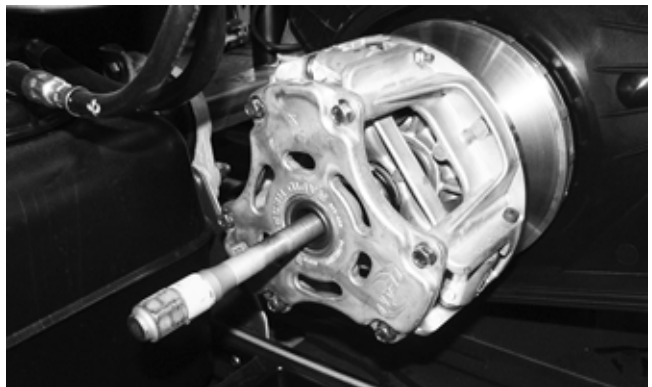

MOD391

9. Remove the Drive and Driven Clutch Holder Tool, drive clutch, driven clutch, and Drive Clutch Puller Tool.

DRIVE CLUTCH

Disassembling

■NOTE: Note the timing marks (X) on the cover, spider, and movable sheave. These must be aligned when assembling the drive clutch for balance purposes.

1. Loosen the machine screws securing the cover. Remove every other cap screw from the cover; then while firmly holding the cover, remove the three remaining screws equally.



MOD457

2. Remove the cover and spring.



MOD458

3. Remove the lock nuts (C) from the cam arm pivot pins (B); then remove the pins and three cam arms (A). Discard lock nuts. Inspect the cam arm pivot pins and replace if damaged.

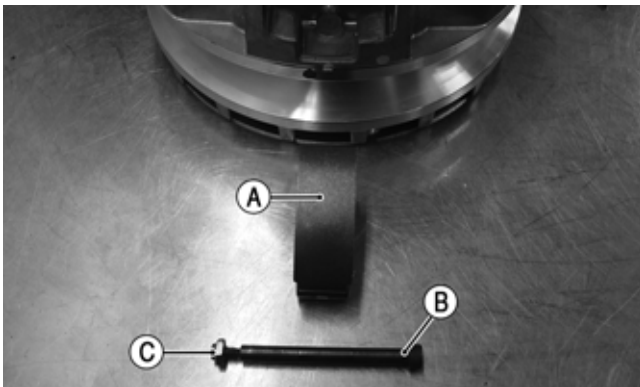

MOD462

Cleaning and Inspecting

■NOTE: If any components other than flyweights, pins, spring, thrust washers, or cover are damaged or worn, clutch replacement is necessary.

1. Using parts-cleaning solvent, wash grease, dirt, and foreign matter off all components; dry with compressed air.
2. Remove any drive belt dust accumulation from the stationary sheave, movable sheave, and bushings using parts-cleaning solvent only.

CAUTION

Do not use steel wool or a wire brush to clean components containing a bushing; damage to the bushing will result.

3. Inspect the cover for cracks or imperfections in the casting.
4. Inspect the cam arm pins for wear or bends.
5. Inspect the bushing in the cover for wear, damage, or cracks.
6. Inspect the spring for cracking or twisting.
7. Inspect the cam arms for grooves.

Assembling

WARNING

Never reuse the lock nuts on the cam arm pins.

1. Place the cam arms, and cam arm pivot pins (pivot pin heads with the direction of rotation) into the movable drive sheave and secure with new lock nuts. Tighten to 50 in.-lb (5.7 N-m).

■NOTE: The drive clutch rotates counterclockwise.

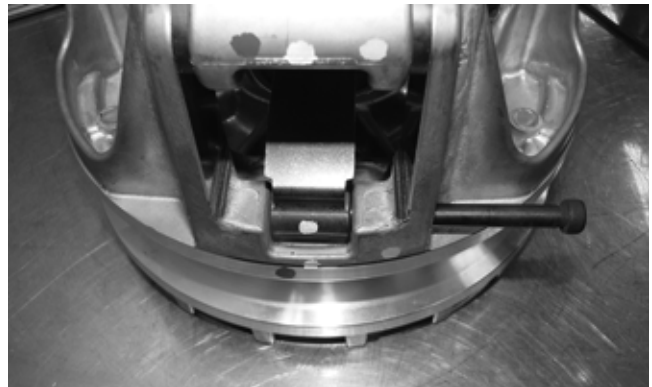

MOD463

■NOTE: Grasp the movable sheave and lift it upward; then release it. It must move freely and not bind at any point.

2. Install the drive spring.

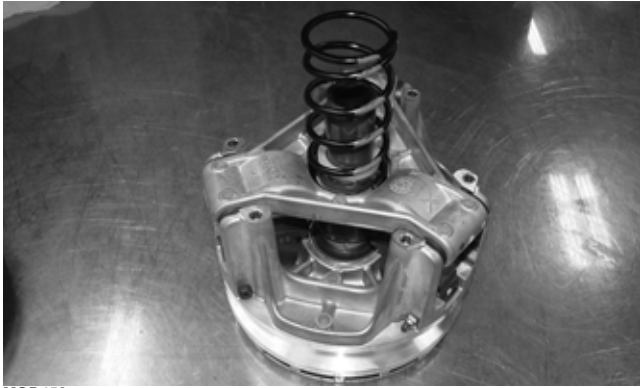

MOD458

3. Align the match marks (X) and install the clutch cover and secure with six cap screws. Tighten using a crisscross pattern to 110 in-lb (12.4 N-m).

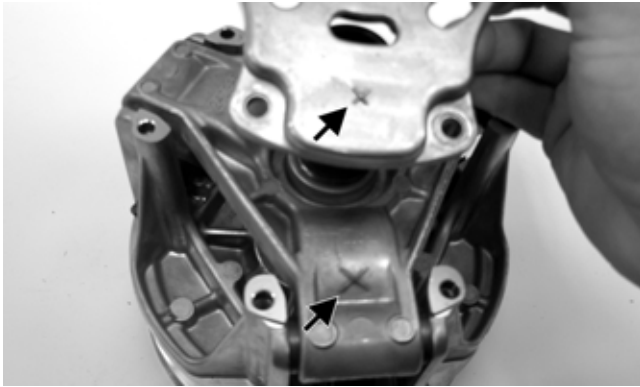

WC653A

DRIVEN CLUTCH

Disassembling

■NOTE: Note the timing marks (X) on the cam, movable sheave, and stationary sheave. These must be aligned when assembling the driven clutch for balance purposes.

1. Using a suitable compressor, put a light amount of pressure compressing the driven clutch; then mark the cam and driven clutch; then remove the four cap screws securing the cam to the driven clutch.

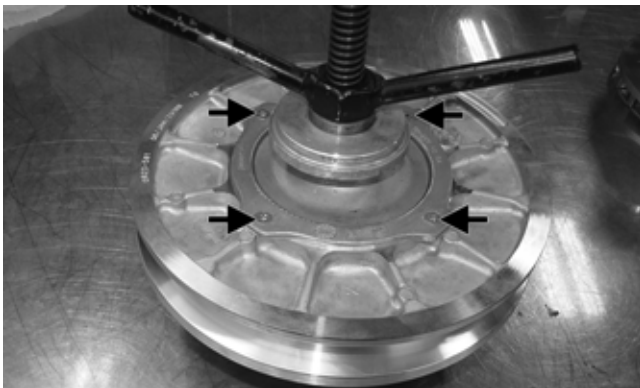

MOD459

2. Gently release the suitable compressor; then remove the cam from the driven clutch assembly.

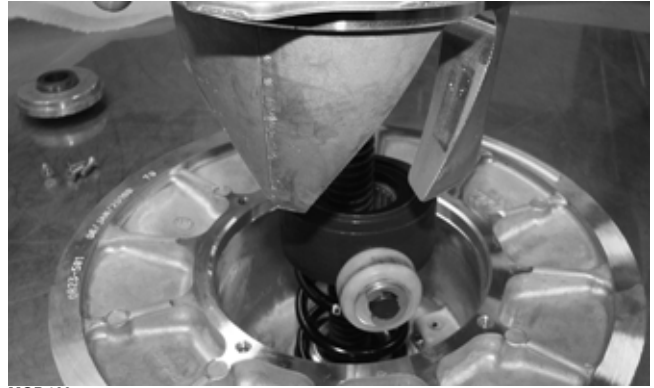

MOD460

3. Remove the spider and driven spring from the driven clutch assembly.

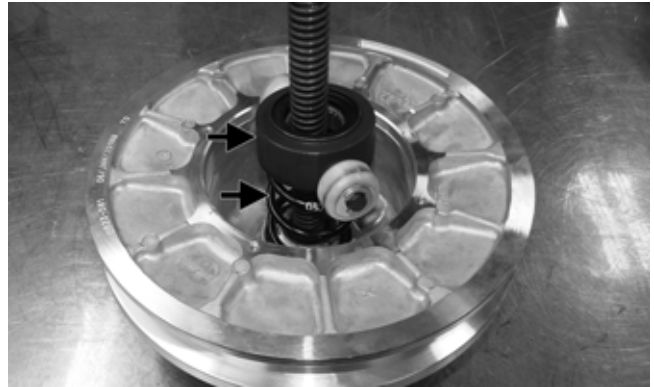

MOD461

4. Remove the E-clips (D) on the end of both the spider arms (A); then remove the rollers (B) and washers (C) from both spider arms.

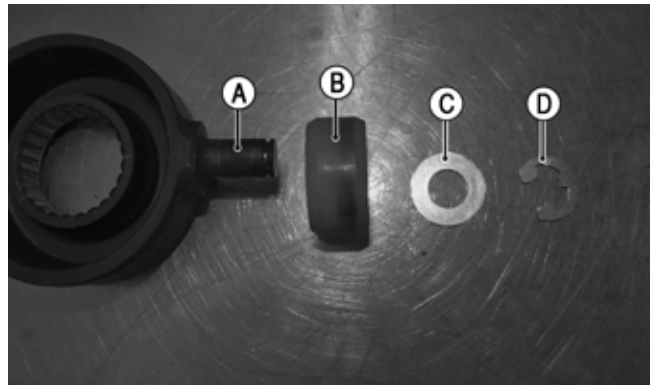

MOD465

5. Using a suitable diameter punch, drive the roll pin securing the roller pin to the driven clutch; then gently remove the roller pin. Repeat for the other side.

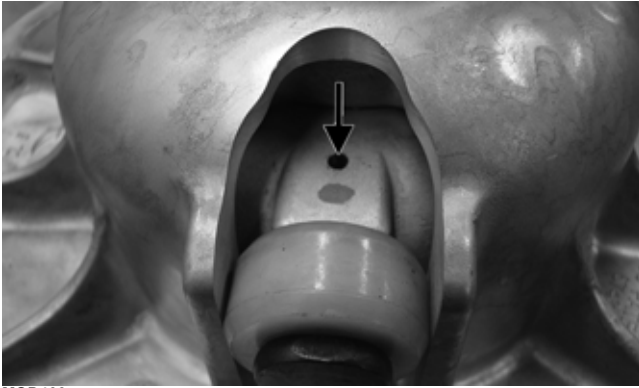

MOD466

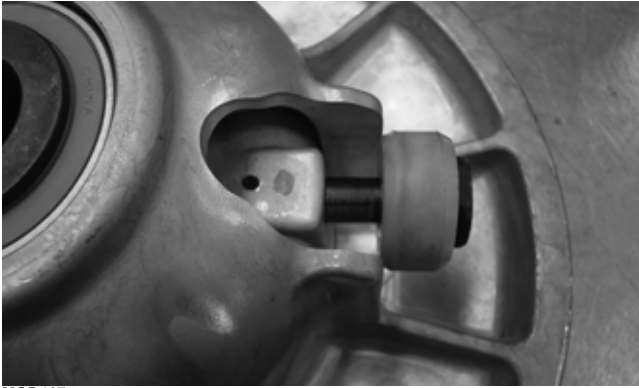

MOD467



MOD468

6. Pull apart the movable and stationary sheaves.

Cleaning and Inspecting

■NOTE: If any components (other than pins, rollers, spring, spider, or cam) are damaged or worn, driven clutch replacement is necessary.

1. Using parts-cleaning solvent, wash grease, dirt, and foreign matter off all components; dry with compressed air.
2. Remove any drive belt dust accumulation from the stationary sheave, movable sheave, and bushings using parts-cleaning solvent only.

CAUTION

Do not use steel wool or a wire brush to clean components containing a bushing; damage to the bushing will result.

3. Inspect the sheaves for cracks or imperfections in the casting.
4. Inspect all clutch components for wear or bends.

5. Inspect the bushing in the movable sheave and stationary sheave for wear, damage, or cracks.
6. Inspect the spring for cracking or twisting.
7. Inspect the cam for grooves.
8. Check the bearings for smoothness and play.

Assembling

1. Position the movable sheave and stationary sheave together, taking note of the alignment "X" marks.

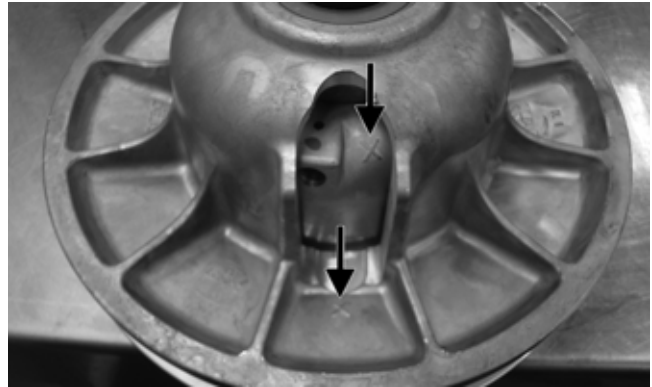

MOD469

2. Install the roller pin with roller taking note of the flat spot that should be away from the sheaves; then align the holes for the new roll pin to be installed; then install the new roll pin. Repeat for the other side.



MOD467

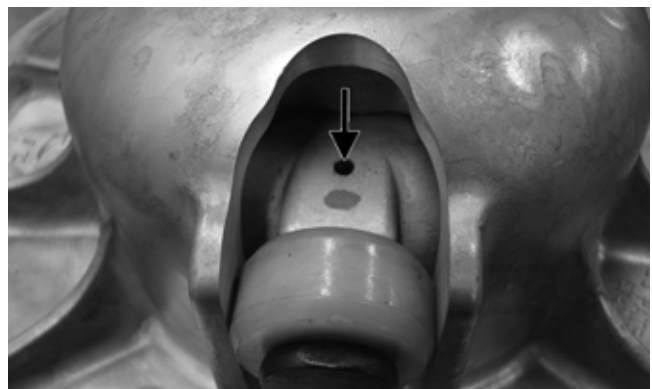

MOD466

3. Install the rollers (B), washers (C) and e-clips (D) onto both of the spider arms (A).

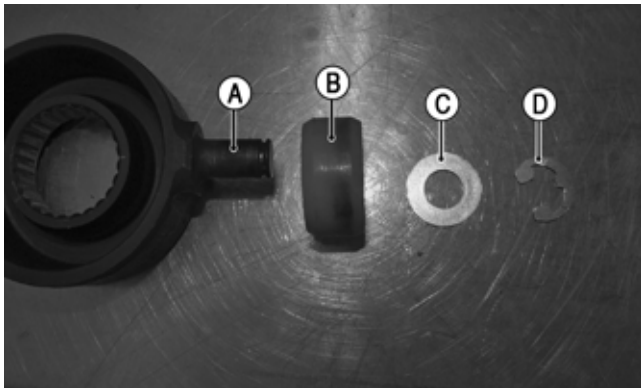

MOD465

4. Install the spring into the clutch assembly with the spring tab in the clutch groove.

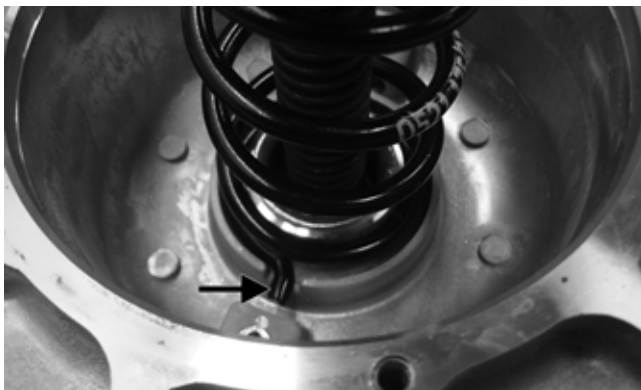

MOD470

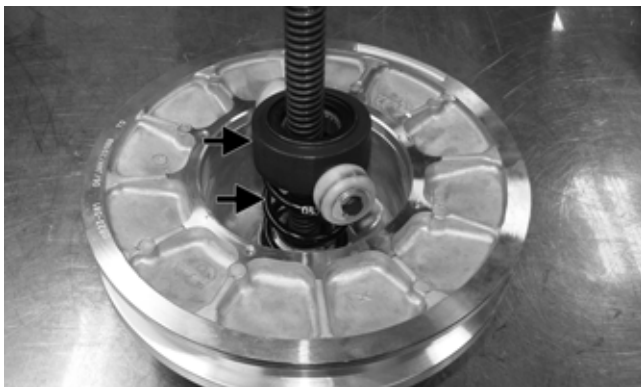

MOD461

5. Place the cam in the movable sheave making sure the "X" timing marks are aligned.

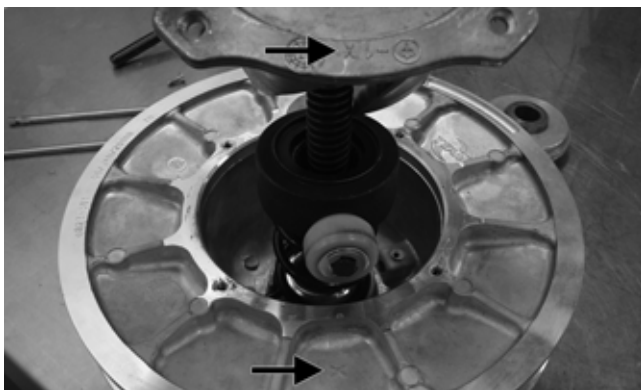

MOD471

6. Using a suitable compressor, put a light amount of pressure compressing the driven clutch; then install the four cap screws securing the cam to the driven clutch. In a crisscross pattern, tighten to 47 in-lb (5.3 N-m).

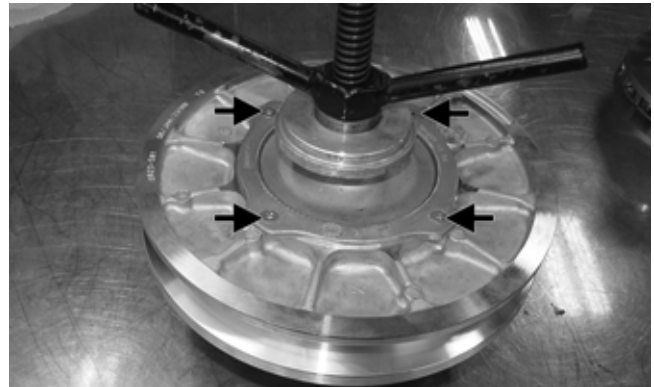

MOD459

CLUTCHES

Installing

1. Place the drive clutch onto the PTO shaft of the engine; then insert the cap screw with washer and hand tighten. Apply a light coat of grease to the inner most splines of the transaxle input shaft; then place the driven clutch onto the input shaft of the transaxle; then secure the drive and driven clutches with the Drive and Driven Clutch Holder Tool.
2. Tighten the drive clutch cap screw to 60 ft-lb (81.6 N-m); then remove the Drive and Driven Clutch Holder Tool.

■ **NOTE:** The arrows on the drive belt should point in direction of engine rotation (forward).

3. Place the drive belt over the drive clutch and put over the top of the driven sheaves.

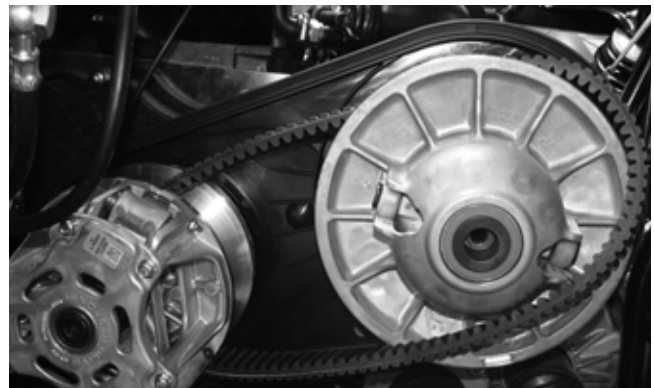

MOD216

4. Push in on the outer portion of the driven clutch while rotating counterclockwise. Insert the cap screw with the washer bevel cup side toward the clutch and hand tighten with no tools.

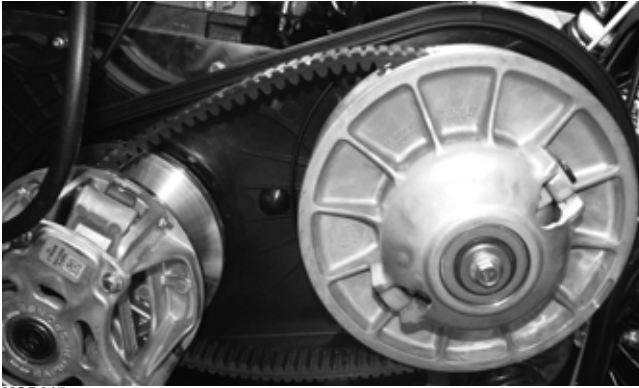

MOD217

5. Continue to push in and rotate the driven clutch counterclockwise while continually tightening the cap screw.
6. When the belt has reached the outermost portion of the driven clutch, tighten the cap screw to 60 ft-lb (81.6 N-m) while holding the driven clutch with the Drive and Driven Clutch Holder Tool.

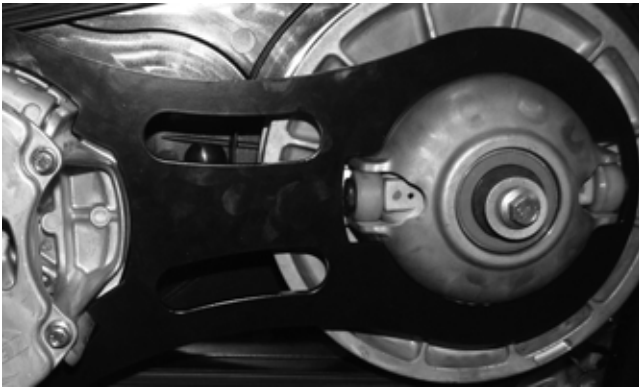

MOD599



MOD218

7. Rotate the driven clutch counterclockwise at least two times to verify belt is in the outermost portion of the sheave. Torque the cap screw to 60 ft lb (81.6 N-m) while holding the driven clutch with the Drive and Driven Clutch Holder Tool

CAUTION

It is crucial to rotate the driven clutch counterclockwise at least two times and torque the driven cap screw after the initial torque.

8. The belt should be as shown on the driven sheave.



MOD219

9. Install the clutch cover making sure the gasket is completely in the groove on the engine side. Install six clamps securing the clutch cover



MOD533

10. Connect clutch air inlet to snorkel portion; then install the clamp that holds the snorkel portion to the air inlet.



MOD205B

11. Reinstall the rear driver side inner fender and secure by rotating the 1/4-turn fasteners clockwise.

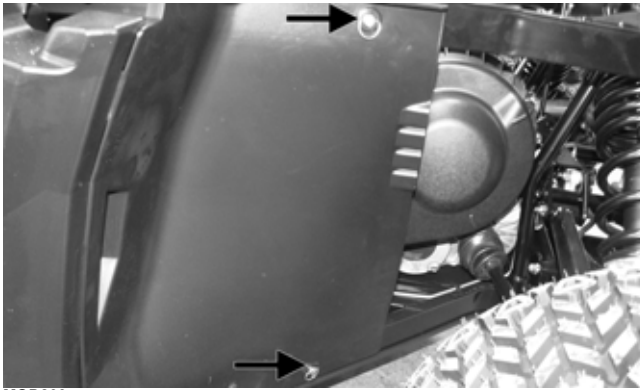

MOD209

FLYWHEEL

■NOTE: For efficiency, it is preferable to remove and disassemble only those components which need to be addressed and to service only those components. The technician should use discretion and sound judgment.

■NOTE: The engine does not have to be removed from the frame for this procedure.

■NOTE: The ring gear is not individually serviceable and must be replaced as an assembly with the flywheel.

Removing

1. Tilt the cargo box up and remove the driver-side rear inner fender; then remove the clutch cover, drive belt, drive clutch, and driven clutch.
2. Near the engine PTO, remove the retaining ring securing the inner clutch cover to the engine; then near the transaxle input shaft, remove the four cap screws securing the inner clutch cover to the transaxle; then remove the inner clutch cover.

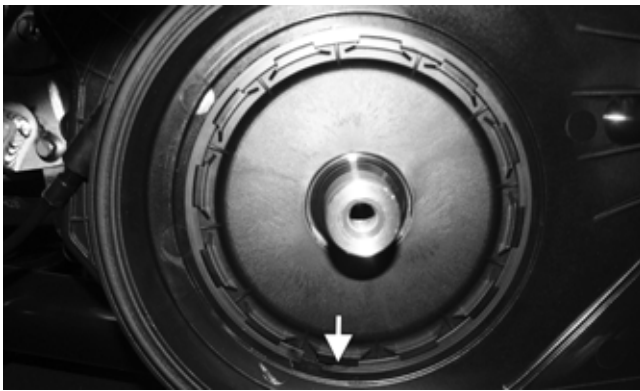

MOD392

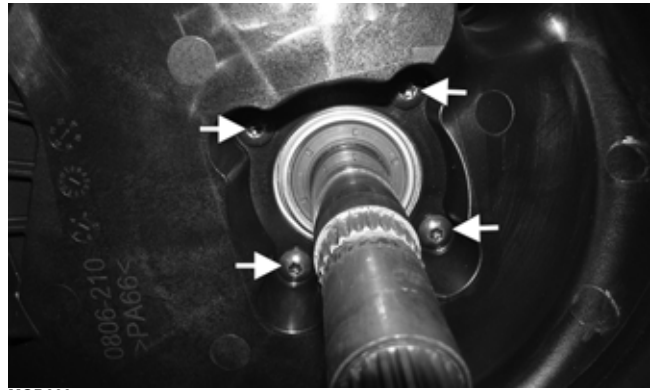

MOD393

3. Remove the cap screws securing the flywheel cover; then remove the flywheel cover; then remove the two cap screws securing the crankshaft position sensor bracket; then remove the crankshaft position sensor from the crankshaft position sensor bracket.

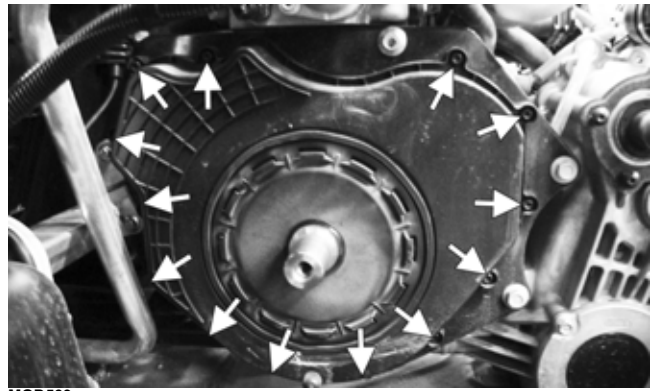

MOD539

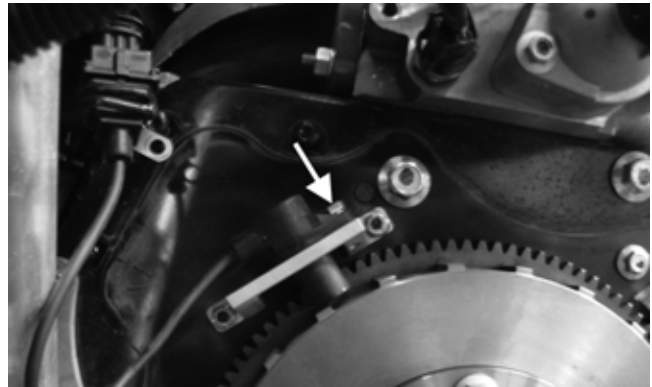

MOD541A

4. Using a suitable tool to hold the PTO/flywheel in place, remove the four cap screws securing the PTO stub shaft to the flywheel; then remove the six cap screws securing the flywheel to the crankshaft.

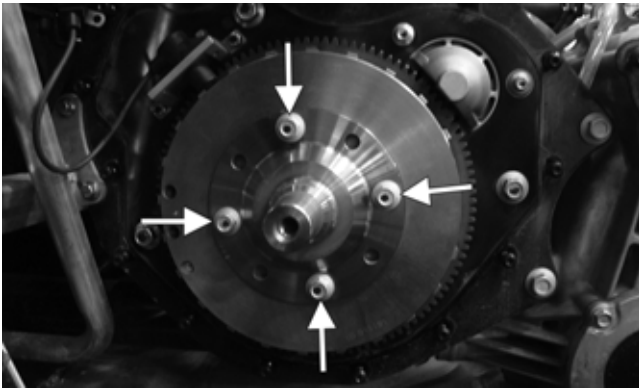

MOD540

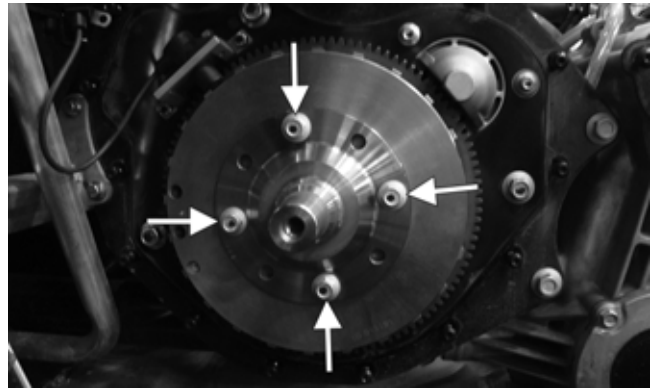

MOD540

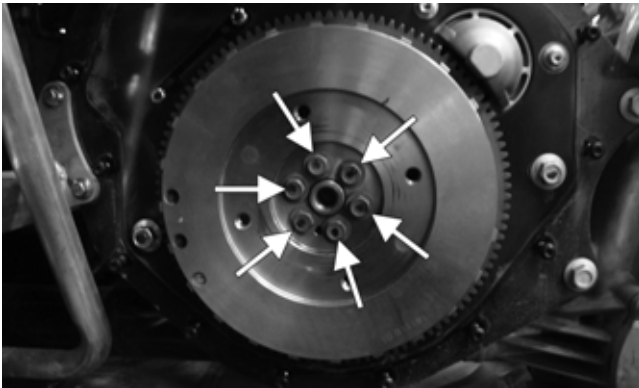

MOD542

Inspecting

1. Inspect the drive belt housing for cracks, elongated mounting holes, or loose alignment pins.
2. Inspect the flywheel/ring gear assembly for worn or broken teeth, cracks, or elongated mounting holes.

■ **NOTE:** The ring gear is not individually serviceable and must be replaced as an assembly with the flywheel.

Installing

1. Using a suitable tool to hold the flywheel in place, install the flywheel on the crankshaft and using the pattern shown, tighten the six cap screws to 51.7 ft-lb (70 N-m); then install the PTO stub shaft and tighten the four cap screws to 36.9 ft-lb (50 N-m).

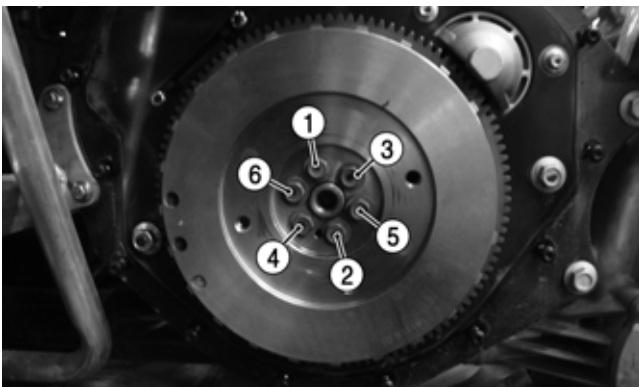

MOD542A

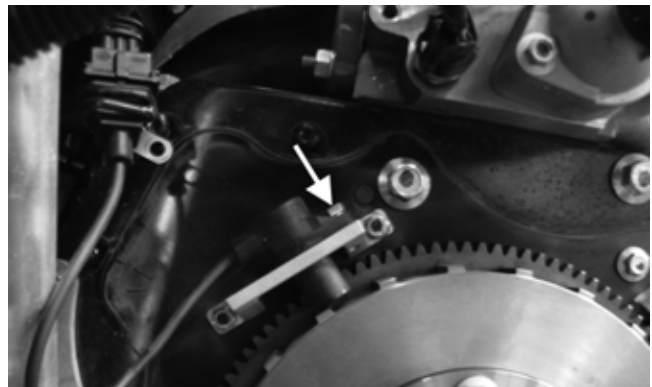

MOD541A

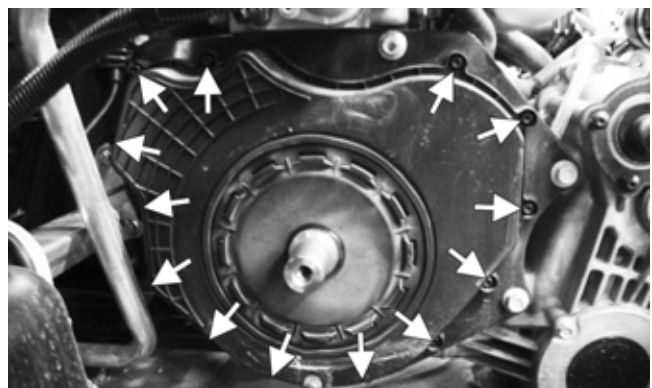

MOD539

3. Install the inner clutch cover; then near the engine PTO, install the retaining ring securing the inner clutch cover to the engine; then near the transaxle input shaft, install the four cap screws securing the inner clutch cover to the transaxle and tighten to 8 ft-lb (10.9 N-m).

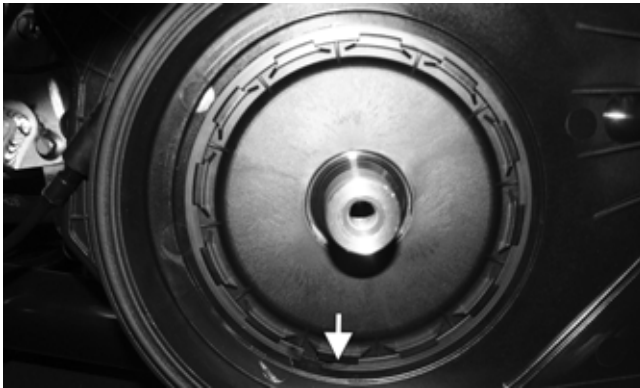

MOD392

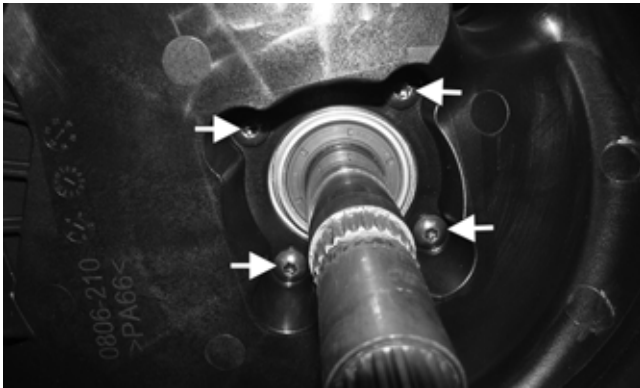

MOD393

4. Install the drive clutch, drive belt, driven clutch and clutch cover.

Engine Block and Components

■NOTE: This procedure cannot be done with the engine in the frame.

- A. Oil Pan
- B. Oil Pump
- C. Crankshaft and Bearings
- D. Connecting Rods, Pistons, and Rings

REMOVING AND INSTALLING OIL PAN

1. Remove the engine from the vehicle (see the sections Removing Engine and Installing Engine).

■NOTE: The engine backplate must be removed to remove oil pan.

2. Remove the cap screws securing the oil pan to the engine block; then carefully break the oil pan loose using a thin putty knife being careful not to bend or distort the oil pan.

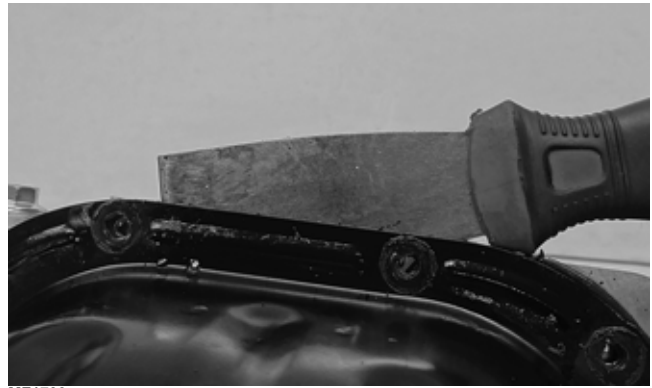

MF1793

3. Thoroughly clean all gasket and sealing materials from the mating surfaces; then invert the oil pan on a flat surface and check for irregularities in the perimeter of the oil pan. Straighten as required.

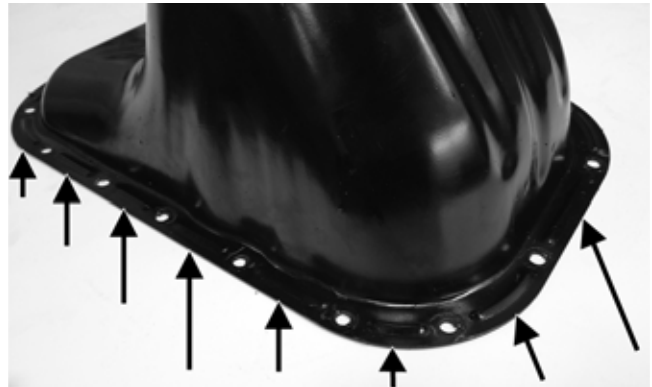

MF237A

4. Apply a thin line of high temperature silicone sealant around the sealing surface of the oil pan as illustrated; then place the oil pan into position on the engine block and secure with the cap screws and tighten evenly to specifications.

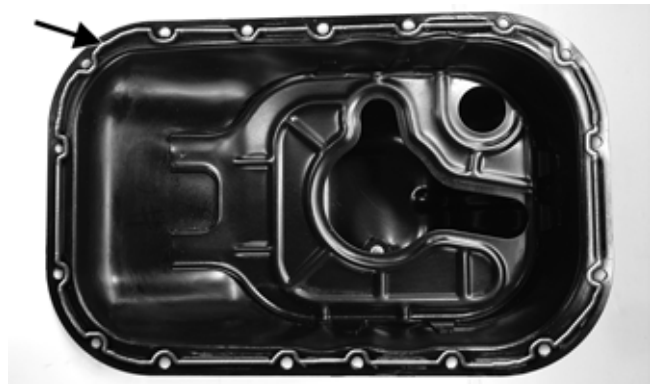

MF289A

5. Install the engine into the chassis (see the sections Removing Engine and Installing Engine).

REMOVING OIL PUMP

■NOTE: The oil pump is only serviceable as an assembly.

1. Remove the engine from the chassis (see the sections Removing Engine and Installing Engine).
2. Remove the oil pan (see REMOVING AND INSTALLING OIL PAN in this section).

3. Remove the timing belt (see Removing Cylinder Head and Related Components in this section).
4. Remove the cap screws securing the oil pickup assembly to the engine block and remove. Account for the gasket.

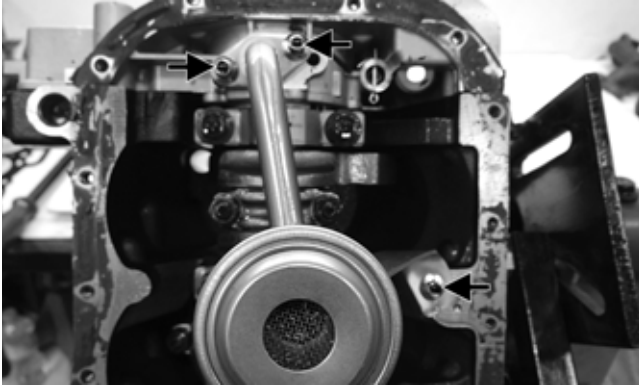

MF181A

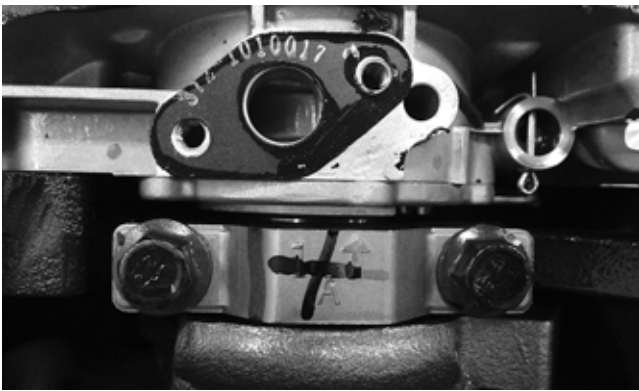

MF182

5. Remove the cap screws securing the oil pump assembly to the engine block and remove the oil pump assembly. Account for two rubber weatherstrip seals and a case gasket.

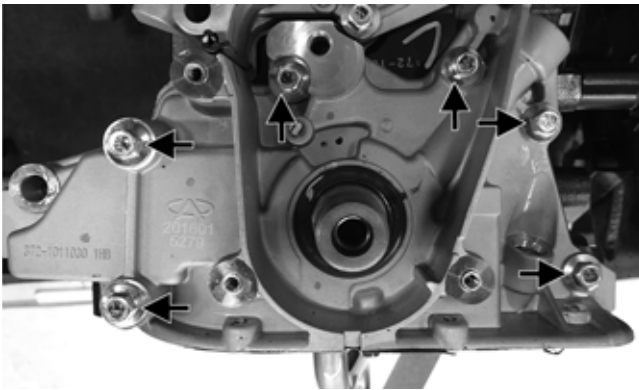

MF180A

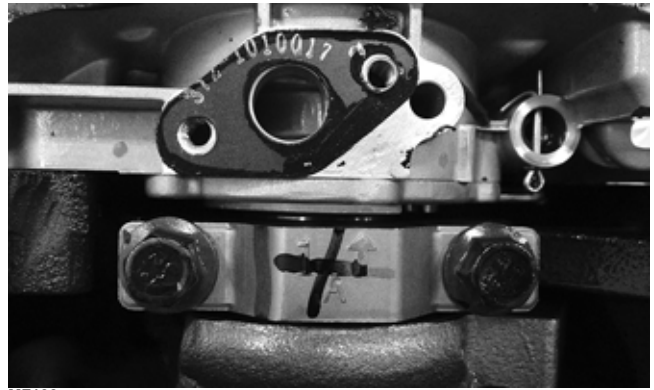

MF182

INSTALLING OIL PUMP

1. Align the flats on the inner rotor bore with the flats on the crankshaft; then using a new gasket and serviceable weatherstrip seals, install the oil pump assembly onto the crankshaft and secure to the engine block with the cap screws. Tighten to specifications.

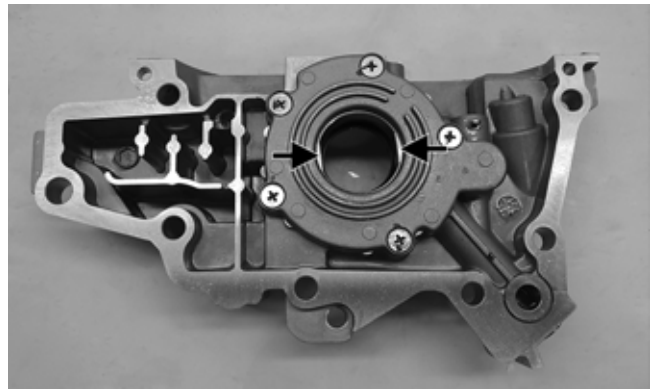

MF186B

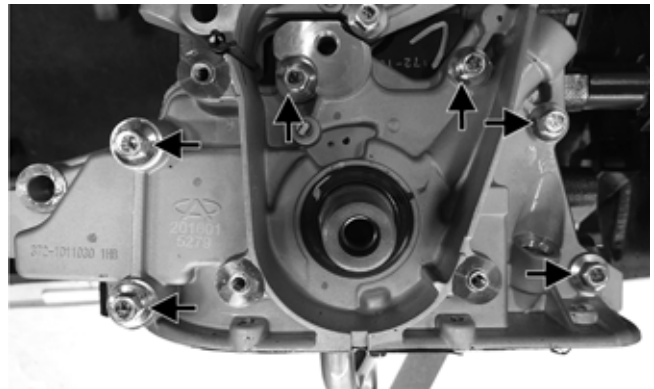

MF180A

2. Using a suitable seal driver, drive a new crankshaft oil seal (D) into the housing bore (lips facing in), until the seal face is flush with the oil pump housing.

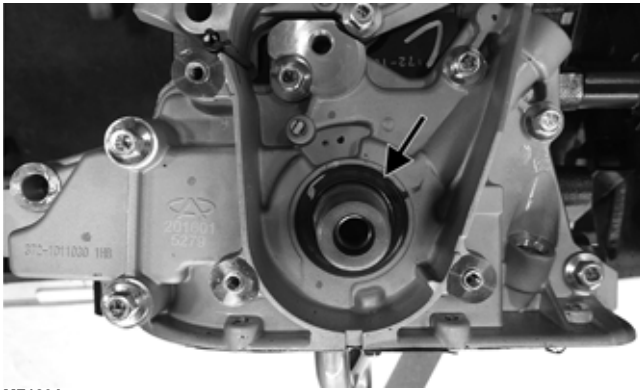

MF180A

- Using a new gasket (C), place the oil pump pick-up assembly (B) into position; then applying a drop of red Loctite to the threads of the cap screws (A), secure the oil pump assembly to the oil pump and engine block. Tighten securely.

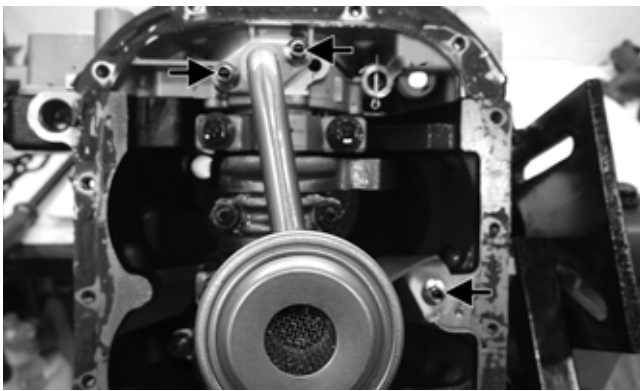

FI595A

- Install the oil pan (see REMOVING AND INSTALLING OIL PAN in this section).
- Install the camshaft drive belt (see REMOVING AND INSTALLING CAMSHAFT DRIVE BELT in this section).
- Install the engine into the chassis (see the sections Removing Engine and Installing Engine).

Installing Engine

- Gently position the engine into the chassis being careful of any electrical components, hoses, straps, etc.
- Clean the engine backplate; then apply black RTV silicone to the engine in the areas indicated; then position the engine backplate into place; then install the four cap screws securing the engine backplate to the engine and tighten to 51.7 ft-lb (70 N-m).

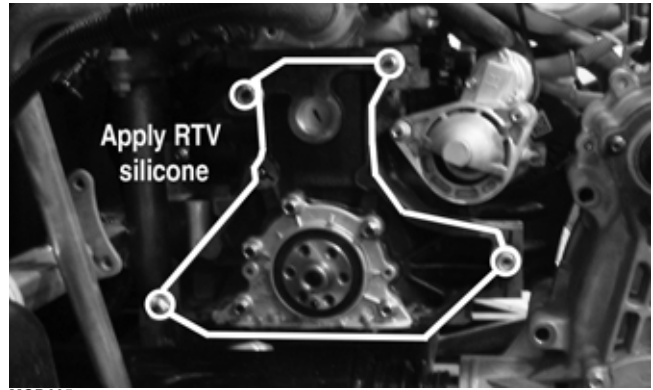

MOD605

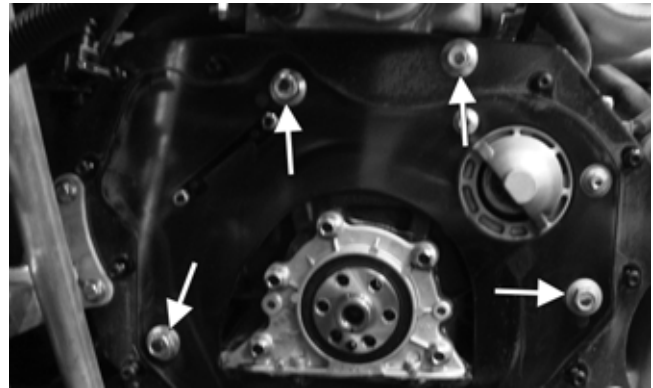

MOD544A

- Install the two cap screws with blue Loctite #243 securing the backplate to the front mount and tighten to 51.7 ft-lb (70 N-m); then position the starter into place and install the two cap screws securing the starter to engine backplate; then tighten to 14.8 ft-lb (20 N-m).



MOD544

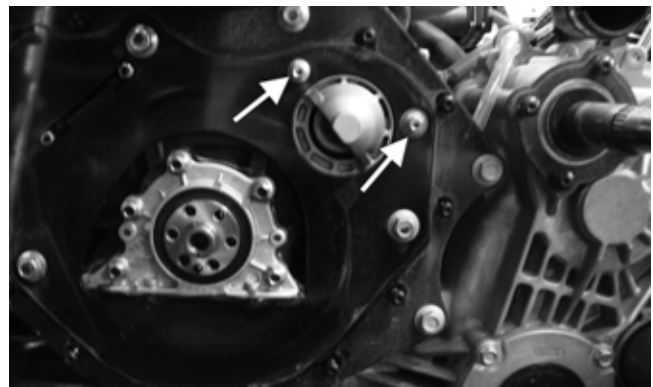

MOD563A

4. Install the four cap screws at the front of the engine below the engine oil filter. Tighten to 55 ft-lb (74.8 N-m).

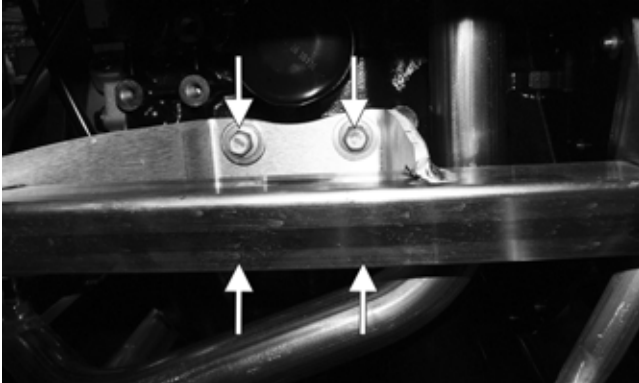

MOD550

5. Located on the PTO side, install the two cap screws with blue Loctite #243 with the spacers between the engine and transaxle. Tighten to 75 ft-lb (102 N-m).

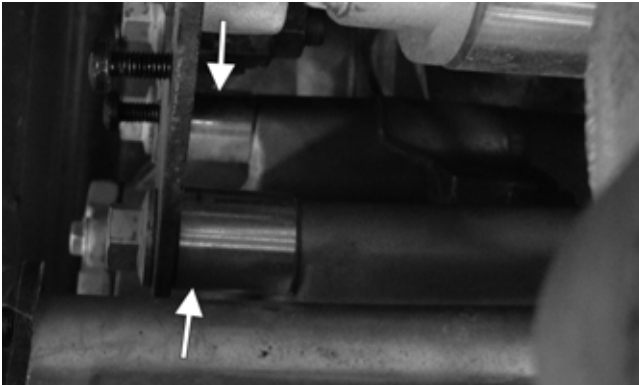

MOD554

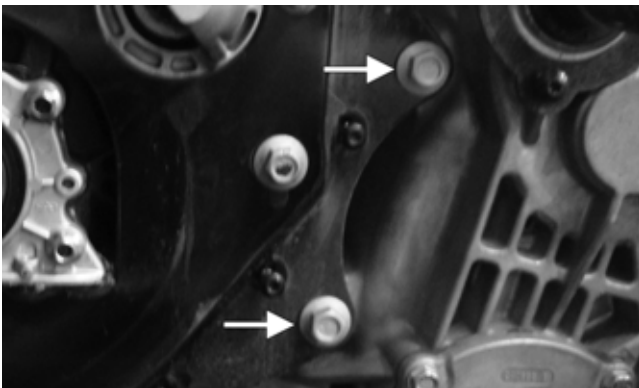

MOD543

6. With a new exhaust gasket, position the exhaust to the exhaust manifold; then install the two cap screws and nuts securing the exhaust to the exhaust manifold. Tighten to 45 ft-lb (61.2 N-m).
7. Remove the tape or other suitable means that was used to plug the intake for the engine.

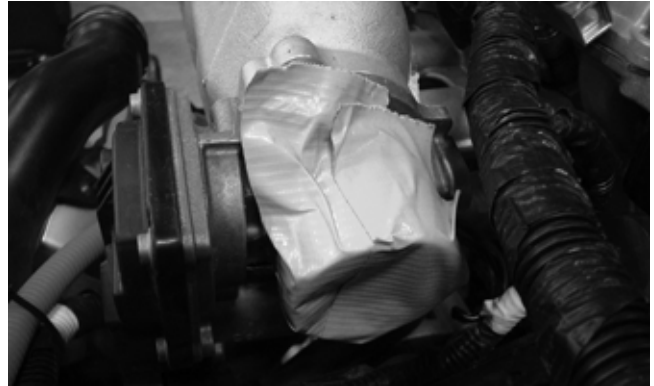

MOD548

8. Install the air intake to the engine and tighten clamp.

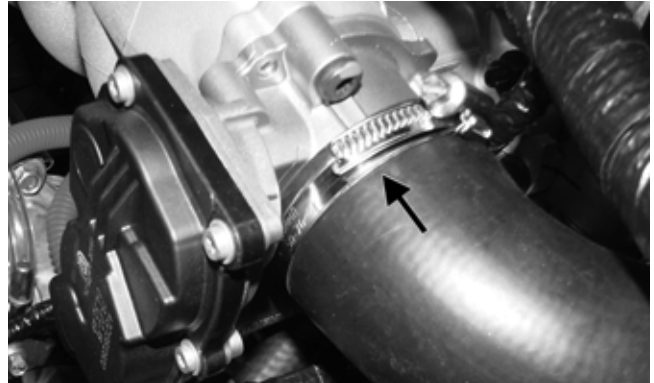

MOD545A

9. Remove the suitable strap putting a slight upward tension on the engine; then remove the suitable strap putting a slight upward tension on the transaxle; then install the flywheel and evenly tighten cap screws to 51.7 ft-lb (70 N-m).



MOD546

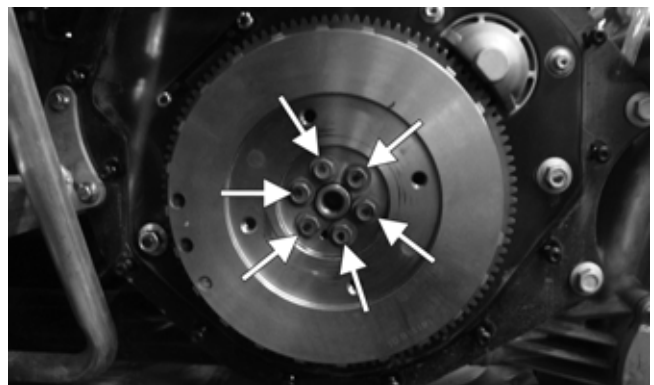

MOD542

10. Install the crank position sensor into the crankshaft position sensor bracket and tighten to 8 ft-lb (10.9 N-m). Install the PTO stub shaft and tighten cap screws to 36.9 ft-lb (50 N-m). Install the flywheel cover and tighten cap screws securely.

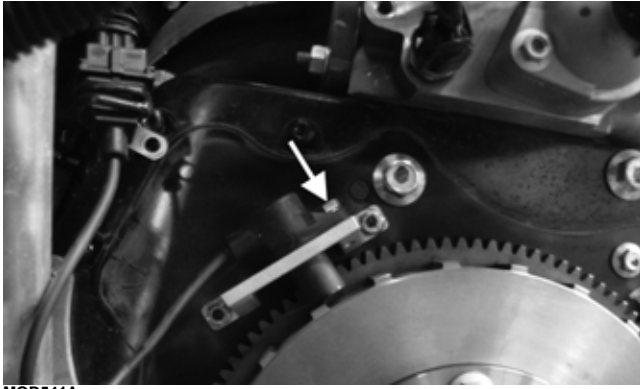

MOD541A

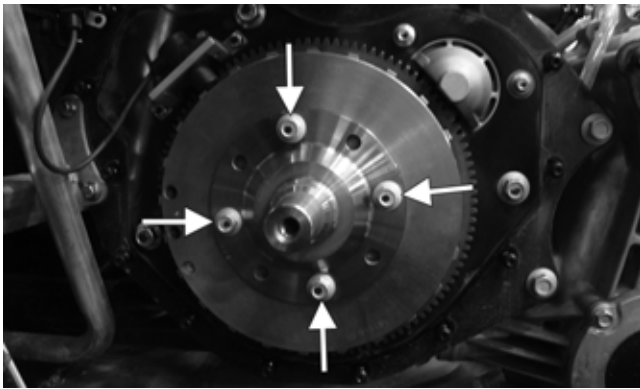

MOD540

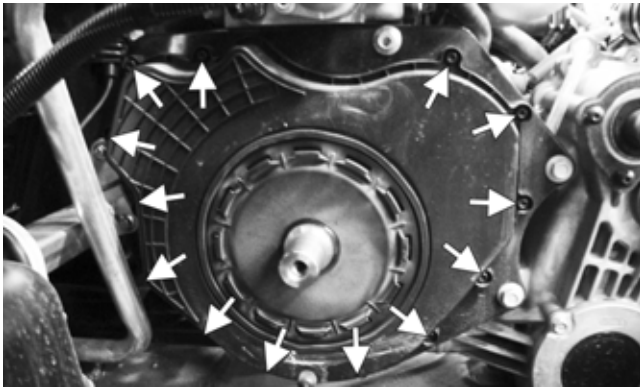

MOD539

11. Connect the gas line to the injector rail; then connect each injector connector to the injector; then connect the electronic throttle control (ETC) connector to the ETC.

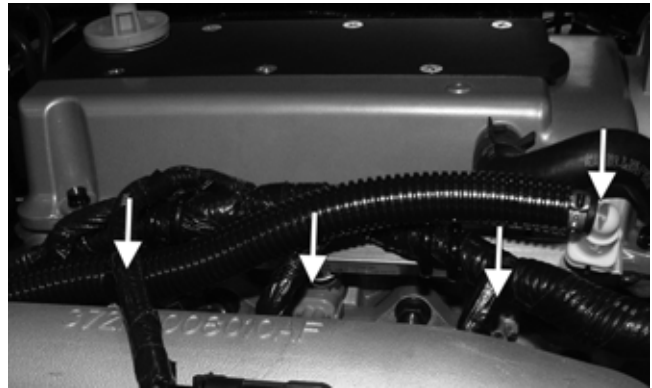

MOD561

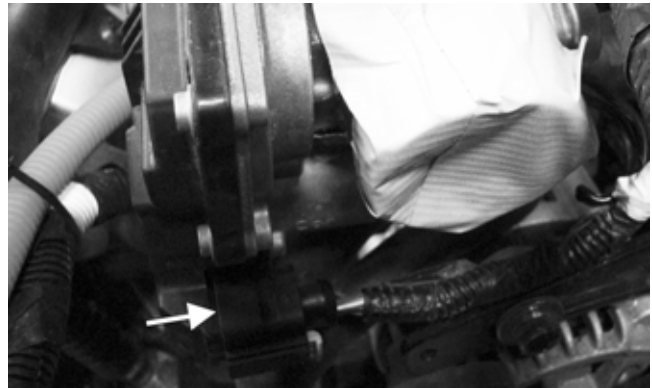

MOD560

12. Install the wires going to the alternator; then install the temperature/manifold absolute pressure (TMAP) connector to the temperature/manifold absolute pressure (TMAP) sensor.

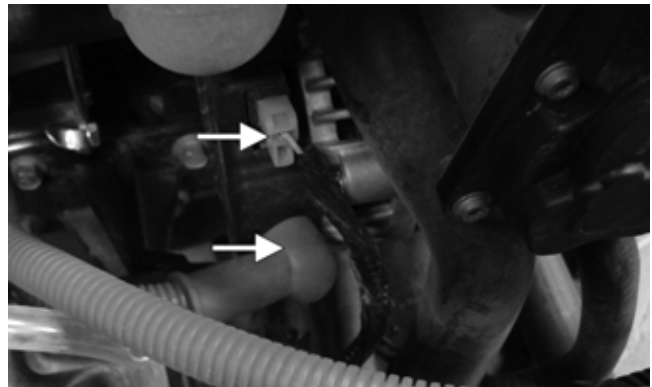

MOD558



MOD559

13. Install the coolant sensor connector to the coolant sensor; then connect the coil connectors to the coils; then install the engine oil pressure switch connector to the engine oil pressure switch that is located near the engine oil filter; then attach the engine ground located above the engine oil pressure switch.

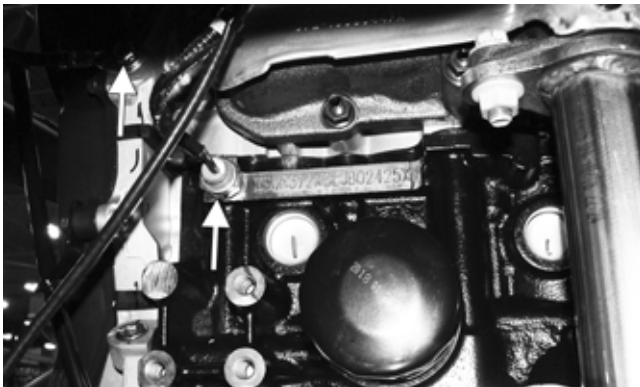
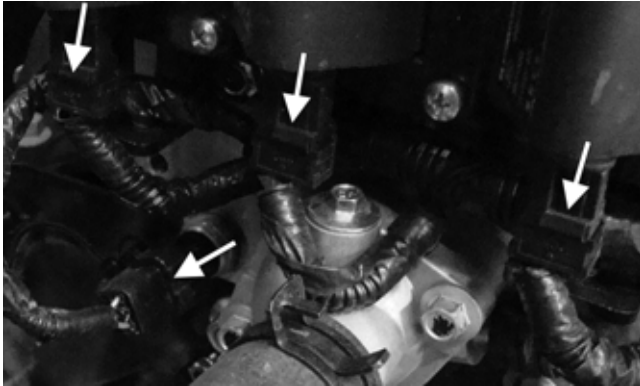

14. Install the driver-side coolant hose to the engine; then install the coolant hose above the starter; then install the coolant hose near the engine intake.

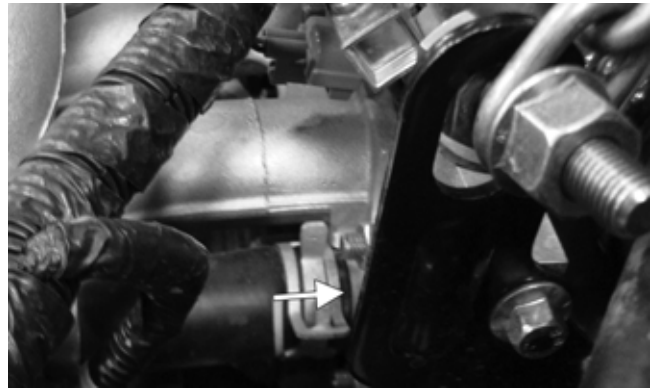
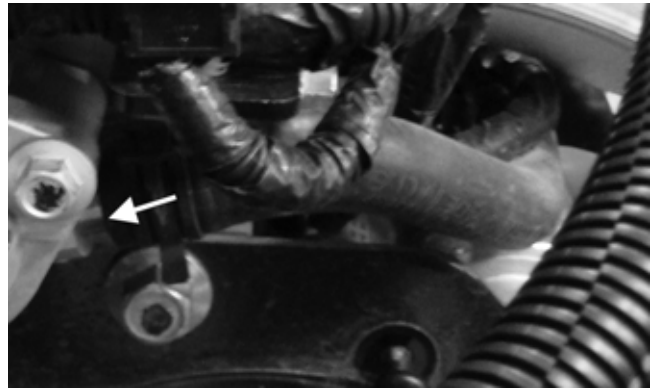

15. Remove the suitable clamps that were used to minimize coolant leakage.

16. Connect the starter wire (A) and start relay wire (B).

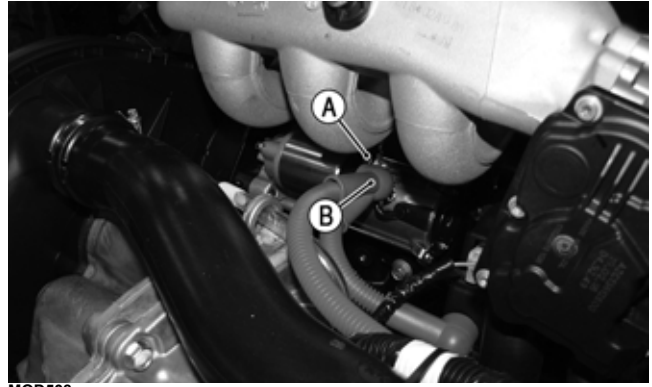

17. Install the inner clutch cover; then install the retaining ring near the PTO securing the inner clutch cover to the engine; then near the transaxle input shaft install the four cap screws securing the inner clutch cover to the transaxle. Tighten the inner clutch cover to transaxle cap screws to 8 ft-lb (10.9 N-m).

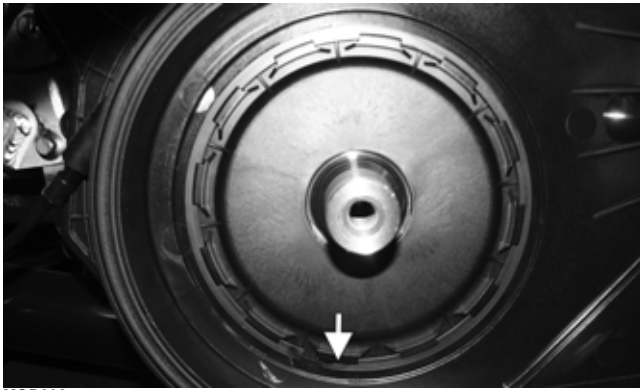

MOD392

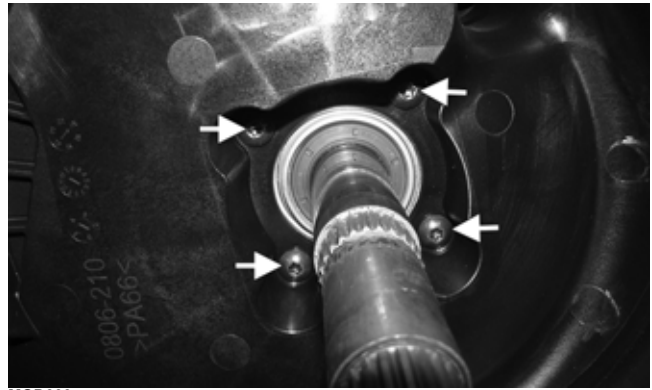

MOD393

18. Install the drive clutch, drive belt, driven clutch and clutch cover; then install the rear inner fenders and cargo box.

19. Fill with coolant (see the Liquid Cooling System section) and bleed the cooling system; then connect the battery connections.

Troubleshooting

Problem: Engine will not start or is hard to start (Compression too low)

| Condition | Remedy |
|-------------------------------------------------------------------------------------------------------------------------------------------------------------------------------------------------------------------------------------------------------------------------------------------------------------------------------------------------|---------------------------------------------------------------------------------------------------------------------------------------------------------------------------------------------------------------------------------------------------------------|
| <ol style="list-style-type: none"> 1. Valve clearance out of adjustment 2. Valve guides worn — seated poorly 3. Valves mistimed 4. Piston rings worn excessively 5. Cylinder bore worn 6. Starter motor cranks too slowly — does not turn | <ol style="list-style-type: none"> 1. Adjust clearance 2. Repair — replace guides 3. Re-time valves 4. Replace rings 5. Replace — re-bore engine block 6. See Electrical System — Troubleshooting |

Problem: Engine will not start or is hard to start (No spark)

| Condition | Remedy |
|--------------------------------------------------------------------------------------------------------------------------------------------------------------------------------------------------------------------------------------------------|---------------------------------------------------------------------------------------------------------------------------------------------------------------------------------------------------------|
| <ol style="list-style-type: none"> 1. Spark plug fouled 2. Spark plug wet 3. ECM defective 4. Ignition coil defective 5. Spark plug wire(s) open — shorted | <ol style="list-style-type: none"> 1. Clean — replace plug 2. Clean — dry plug 3. Replace ECM 4. Replace ignition coil 5. Replace spark plug wire(s) |

Problem: Engine will not start or is hard to start (No fuel reaching the fuel injectors)

| Condition | Remedy |
|---------------------------------------------------------------------------------------------------------------------------------------------------------------------------------------------------------------------|------------------------------------------------------------------------------------------------------------------------------------------------------------------------------|
| <ol style="list-style-type: none"> 1. Gas tank vent hose obstructed 2. Fuel hose obstructed 3. Fuel screens obstructed 4. Fuel pump defective | <ol style="list-style-type: none"> 1. Clean vent hose 2. Clean — replace hose 3. Clean — replace inlet screen 4. Replace fuel pump |

Problem: Engine noisy (Excessive valve chatter)

| Condition | Remedy |
|-------------------------------------------------------------------------------------------------------------------------------------------------------------------------|----------------------------------------------------------------------------------------------------------------------------------|
| <ol style="list-style-type: none"> 1. Valve clearance too large 2. Valve spring(s) weak — broken 3. Camshaft worn | <ol style="list-style-type: none"> 1. Adjust clearance 2. Replace spring(s) 3. Replace camshaft |

Problem: Engine noisy (Noise seems to come from piston)

| Condition | Remedy |
|----------------------------------------------------------------------------------------------------------------------------------------------------------------------------------------------------------------------------------------------------|----------------------------------------------------------------------------------------------------------------------------------------------------------------------------------------------------|
| <ol style="list-style-type: none"> 1. Piston — cylinder worn 2. Combustion chamber carbon buildup 3. Piston pin — piston pin bore worn 4. Piston rings — ring groove(s) worn | <ol style="list-style-type: none"> 1. Replace — service piston — engine block 2. Clean chamber 3. Replace — service pin — bore 4. Replace rings — piston |

Problem: Engine noisy (Noise seems to come from crankshaft)

| Condition | Remedy |
|------------------------------------------------------------------------------------|-----------------------------------------------------------------------------------------|
| <ol style="list-style-type: none"> 1. Bearings worn — burned | <ol style="list-style-type: none"> 1. Replace bearings and/or crankshaft |

| Problem: Engine idles poorly | |
|-------------------------------------------------------------------------------------------------------------------------------------------------------------------------------------------------------------------------------------------------------------------------------------------------------------------------------------------------------------------------------------------------------------------------------------------------------------------|-------------------------------------------------------------------------------------------------------------------------------------------------------------------------------------------------------------------------------------------------------------------------------------------------------------------------------------------------------------------------------------------|
| Condition | Remedy |
| <ol style="list-style-type: none"> 1. Valve clearance out of adjustment 2. Valve seating poor 3. Valve guides defective 4. Fuel injector obstructed | <ol style="list-style-type: none"> 1. Adjust clearance 2. Replace — service seats — valves 3. Replace guides 4. Replace fuel injector |
| Problem: Engine runs poorly at high speed | |
| Condition | Remedy |
| <ol style="list-style-type: none"> 1. Valve springs weak 2. Valves mistimed 3. Cams worn 4. Air cleaner element obstructed 5. Fuel hose obstructed 6. Ignition coil defective | <ol style="list-style-type: none"> 1. Replace springs 2. Re-time valves 3. Replace cams 4. Clean — replace element 5. Clean — replace hose 6. Replace ignition coil |
| Problem: Exhaust smoke dirty or heavy | |
| Condition | Remedy |
| <ol style="list-style-type: none"> 1. Oil (in the engine) overfilled — contaminated 2. Piston rings — cylinder worn 3. Valve guides worn 4. Cylinder wall scored — scuffed 5. Valve stems worn 6. Stem seals defective 7. Air cleaner element obstructed | <ol style="list-style-type: none"> 1. Drain excess oil — replace oil 2. Replace — service rings — cylinder 3. Replace guides 4. Replace — bore engine block 5. Replace valves 6. Replace seals 7. Clean — replace element |
| Problem: Engine lacks power | |
| Condition | Remedy |
| <ol style="list-style-type: none"> 1. Valve clearance incorrect 2. Valve springs weak 3. Valves mistimed 4. Piston ring(s) — cylinder worn 5. Valve seating poor 6. Cams worn 7. Air cleaner element obstructed 8. Oil (in the engine) overfilled — contaminated | <ol style="list-style-type: none"> 1. Adjust clearance 2. Replace springs 3. Re-time valves 4. Replace — service rings — engine block 5. Repair seats 6. Replace cams 7. Clean element 8. Drain excess oil — change oil |
| Problem: Engine overheats | |
| Condition | Remedy |
| <ol style="list-style-type: none"> 1. Air filter restricted 2. Oil low 3. Fuel incorrect 4. Oil pump defective 5. Oil circuit obstructed 6. Coolant level low 7. Fan malfunctioning 8. Fan switch malfunctioning 9. Thermostat stuck — closed 10. Radiator hoses — cap damaged — obstructed | <ol style="list-style-type: none"> 1. Clean — replace air filter 2. Add oil 3. Drain — replace fuel 4. Replace pump 5. Clean circuit 6. Fill — examine system for leaks 7. Check fan fuse — replace fan 8. Replace fan switch 9. Replace thermostat 10. Clear obstruction — replace hoses |

Fuel/Lubrication/ Cooling

■NOTE: Some photographs and illustrations used in this section are used for clarity purposes only and are not designed to depict actual conditions.

TROUBLESHOOTING

1. Verify that the electric fuel pump is operating by listening for a “whirring” sound for several seconds after the key switch is turned to the ON position. If no sound can be heard, see FUEL PUMP/FUEL LEVEL SENSOR in Electrical System.
2. Check for a flashing Engine Management Malfunction icon on the LCD. If this is flashing, see Gauge Diagnostic Menu in Electrical System.
3. Make sure there is sufficient, clean gas in the gas tank.

Throttle Body

■NOTE: The throttle body is only serviceable as an assembly (see the Electrical System section).

Gas Tank

⚠ WARNING

Whenever any maintenance or inspection is made on the fuel system during which there may be fuel leakage, there should be no welding, smoking, open flames, etc., in the area.

REMOVING

■NOTE: Gas tank removal should only be necessary if the tank is leaking fuel or has been contaminated with water or dirt, or inadvertently filled with diesel fuel.

1. Remove the seats, seat backs, seat base, behind-the-seat storage box panel, and side panels; then remove the floor.
2. Disconnect the vent hose (A), fuel hose (B), and fuel pump/gas level sensor connector (C); then cap the vent fitting and gas hose fitting; then remove the fuel tank.

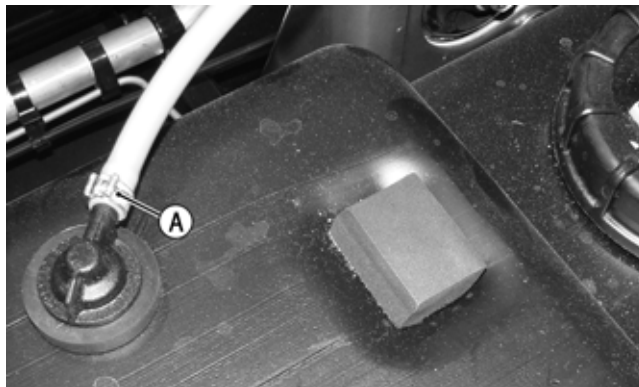

MOD567

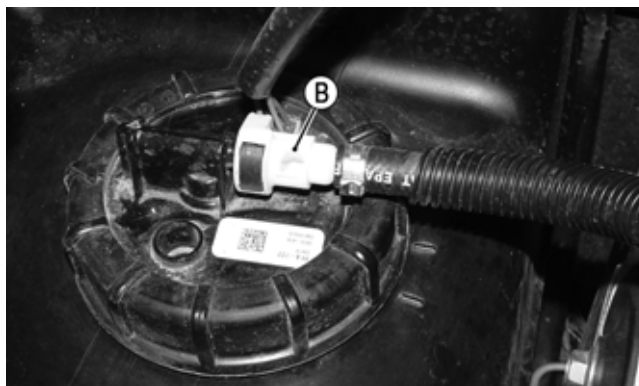

MOD566

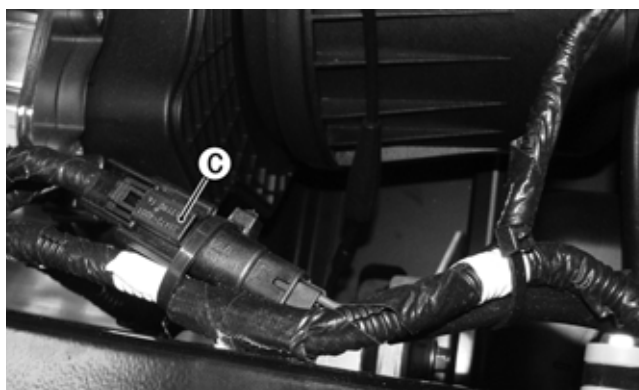

MOD295A

CLEANING AND INSPECTING

■NOTE: Whenever a part is worn excessively, cracked, or damaged in any way, replacement is necessary.

1. Clean the gas level sensor and gas pick-up screen.
2. Completely drain all contaminated gas from the gas tank; then thoroughly wash the tank out with hot, soapy water.
3. Dry the tank interior with compressed air.

■NOTE: Repeat steps 2 and 3 until all contaminants are removed.

4. Flush the fuel screen with hot, soapy water and dry with compressed air.

■NOTE: If any pinholes are noted in the gas screen, replace the gas level sensor assembly.

5. Inspect the tank cap and filler neck for chipped or broken threads.

6. Inspect the gas tank mountings for security, signs of cracking, or wearing through the tank.
7. Inspect all gas and vent hoses for cracks, softening, or deterioration. Replace as required.

INSTALLING

WARNING

Whenever any maintenance or inspection is made on the gas system during which there may be gas leakage, there should be no welding, smoking, open flames, etc., in the area.

1. Place the gas tank into position in the vehicle; then connect the vent hose (A), gas hose (B), and fuel pump/gas level sensor connector (C).

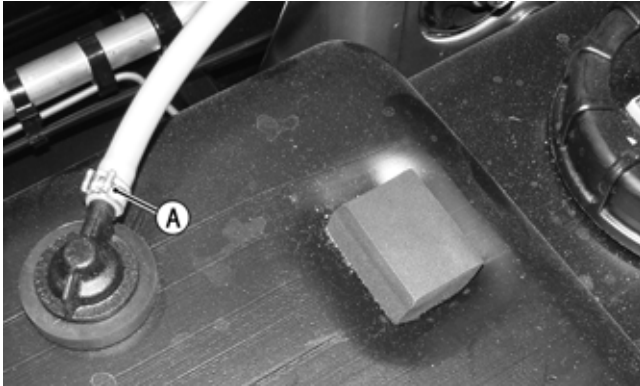

MOD567

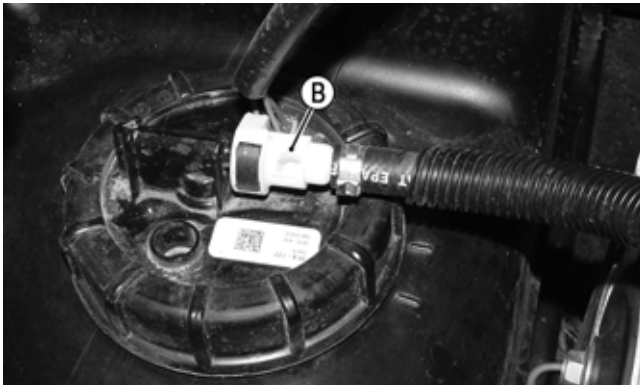

MOD566

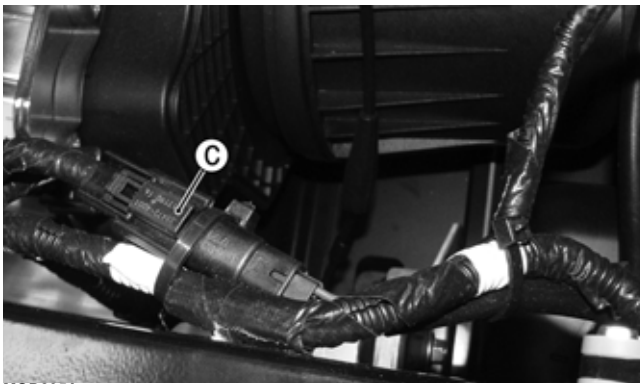

MOD295A

2. Install the floor; then install the behind-the-seat storage box panel, seat base, seat backs, seat, and side panels.

Fuel Pump

■NOTE: The fuel pump is only serviceable as an assembly (see the Electrical System section).

Fuel/Vent Hoses

Inspect the fuel lines per the maintenance schedule. Damage from aging may not always be visible. Do not bend or obstruct the routing of the vent hose or fuel return hose.

Oil Filter/Oil Pump

■NOTE: Whenever internal engine components wear excessively or break and whenever oil is contaminated, the oil pump should be replaced. The oil pump is only serviceable as an assembly.

TESTING OIL PUMP PRESSURE

■NOTE: The engine must be warmed up to operating temperature (cooling fan cycling) for this test.

1. Use the LCD gauge to monitor the RPM of the engine.
2. Tilt the cargo box into the up position; then disconnect the oil pressure switch connector; then remove the oil pressure switch from the engine; then connect a oil pressure tester to the oil pressure switch port.

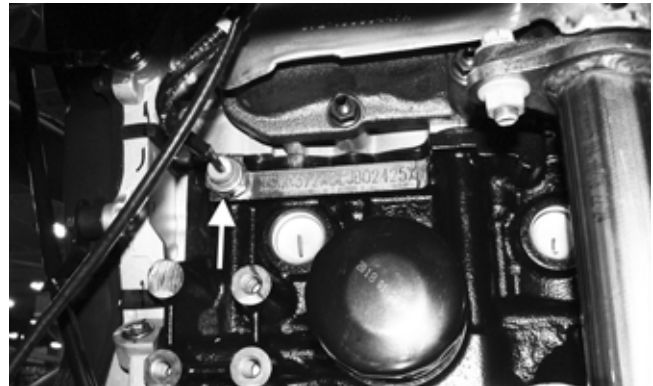

MOD557A

■NOTE: Some oil seepage may occur when installing the oil pressure gauge. Wipe up oil residue with a cloth.

3. Start the engine. At idle the oil pressure gauge must read greater than 4.35-7.25 psi (30-50 kPa).

■NOTE: If oil pressure is lower than specified, check for an oil leak, damaged oil seal, or defective oil pump.

Liquid Cooling System

■NOTE: Use a good quality, biodegradable glycol-based, automotive-type antifreeze. When filling the cooling system, use a 60/40 coolant/water mixture or one which will satisfy the coldest anticipated weather conditions of the area in accordance with the coolant manufacturer's recommendations.

⚠ WARNING

Never check the coolant level when the engine is hot or the cooling system is under pressure.

CAUTION

After operating the vehicle for the initial 5-10 minutes, stop the engine, allow the engine to cool down, and check the coolant level. Add coolant as necessary.

■NOTE: Debris in the engine compartment or packed between the cooling fins of the radiator can reduce cooling capability. Using a garden hose, wash the radiator to remove any debris preventing air flow.

CAUTION

It is not recommended to use a pressure washer to clean the radiator core. The pressure may bend or flatten the fins causing restricted air flow, and electrical components on the radiator could be damaged. Use only a garden hose with spray nozzle at normal tap pressure.

Always maintain the coolant level at the cold fill line of the coolant reservoir.

Checking Coolant

1. Lift the hood by turning the 1/4-turn fasteners located at the rear of the hood. Remove the hood by sliding it toward the rear of the vehicle and out of the slots in the grille.

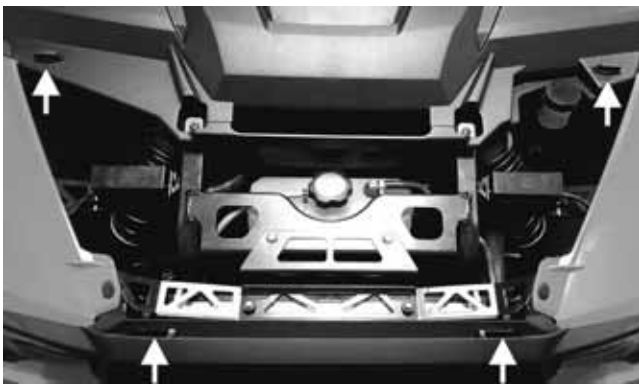

MOD044A

2. Inspect the coolant level cold. The level shouldn't be lower than the cold full line. When it's at operating temperature, the coolant level may be above the cold full line.



MOD043

■NOTE: If you cannot see any coolant in the reservoir, inspect the cooling system for leaks. If no leaks are present, add coolant using the bleed procedure below.

Bleeding Cooling System

While the cooling system is being filled, air pockets may develop; therefore, make sure the cooling system is properly bled, with no trapped air in the system.

1. Slowly loosen the plug from the top of the thermostat housing above the drive clutch, allowing trapped air to escape.

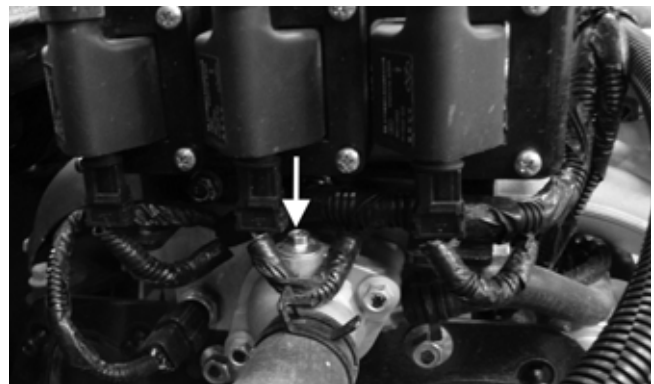

MOD588

2. When pure coolant (no air) flows from the bleed hole, tighten the bleed plug and tighten securely.
3. Fill the cooling system to the cold fill line of the reservoir. Run the engine until the radiator fan engages and disengages after the initial fill; then shut off the engine and recheck coolant level once cool.

■NOTE: Use a good quality, biodegradable glycol-based, automotive-type antifreeze.

RADIATOR

Removing

1. Remove the hood; then remove the two cap screws securing the inner portion of the front fenders and the grille.



MODC054

2. Gently lift up on the front fenders where it meets the grille to gain access to the upper headlight cap screw; then remove the upper headlight cap screw; then repeat for other side.

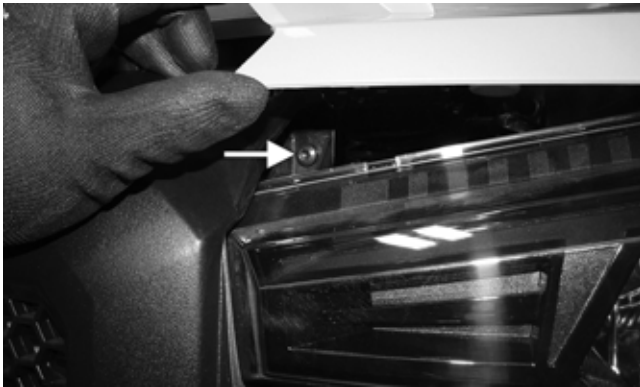

MODC071

CAUTION

When removing radiator hoses, coolant will come out. Use a suitable drain pan or absorbent material to catch and absorb coolant.

3. Loosen and slide back the lower radiator hose clamp on the passenger side; then using a suitable clamp, clamp the hose to minimize coolant leakage; then disconnect the lower hose from the radiator; then loosen and slide back the upper radiator hose clamps on the driver side; then using suitable clamps, clamp the hoses to minimize coolant leakage; then disconnect the upper hoses.



MOD476

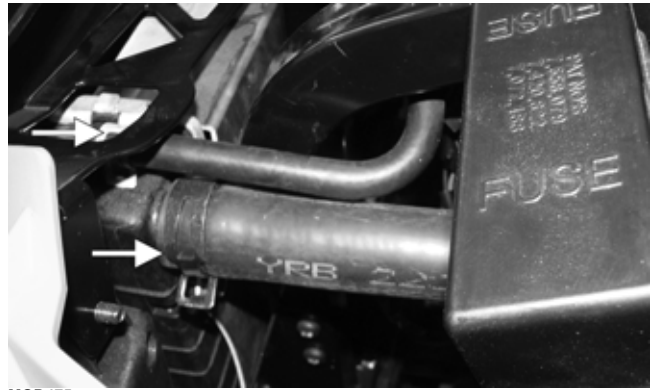

MOD475

4. Remove the two cap screws and lock nuts securing the radiator bracket to the frame; then remove the radiator bracket from the vehicle; then disconnect the radiator fan electrical connection. Discard lock nuts. Inspect cap screws and replace if damaged.

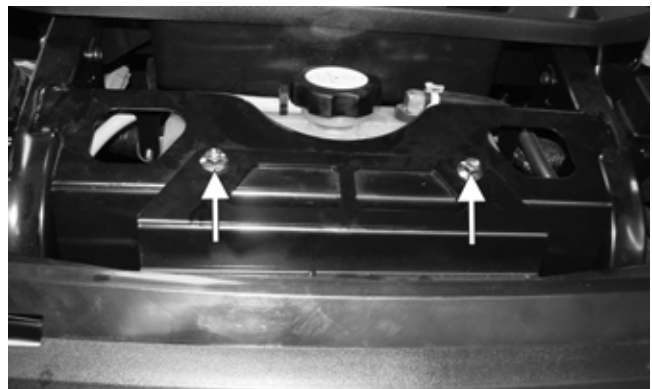

MOD473



MOD474

5. Lift the radiator assembly from the vehicle. Account for two upper and two lower rubber mounting grommets.

Cleaning and Inspecting

1. Flush the radiator with water to remove any contaminants.
2. Inspect the radiator for leaks and damage.
3. Inspect all hoses for cracks and deterioration.
4. Inspect all fasteners and grommets for damage or wear.

Installing

1. Place the radiator into position, making sure the grommets are correctly installed; then install the radiator bracket into the vehicle; then secure the radiator bracket with the two cap screws and new lock nuts; then tighten to 20 ft-lb (27.2 N-m); then connect the radiator fan electrical connection.

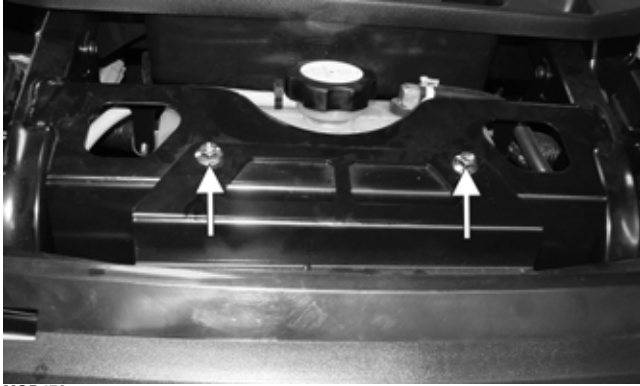

MOD473



MOD474

2. Connect the lower radiator hose to the radiator; then remove the suitable clamp to minimize coolant leakage; then loosen and slide the radiator hose clamp toward the radiator; then tighten the clamp securing the lower radiator hose to the radiator; then connect the upper radiator hoses to the radiator; then remove the suitable clamps to minimize coolant leakage; then loosen and slide the radiator hose clamp toward the radiator; then tighten the clamp securing the upper radiator hoses to the radiator.

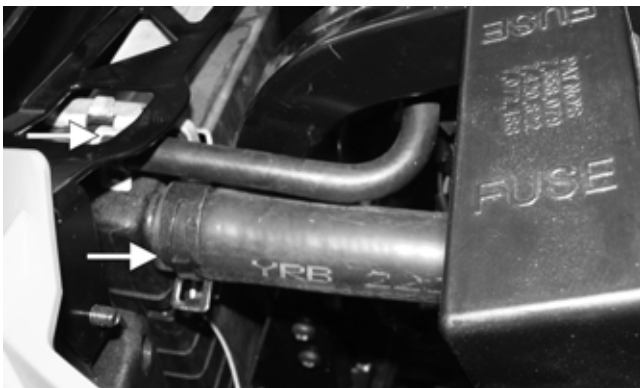

MOD475



MOD476

3. Gently lift up on each front fender where it meets the grille to be able to install the upper headlight cap screw; then install the upper headlight cap screw.

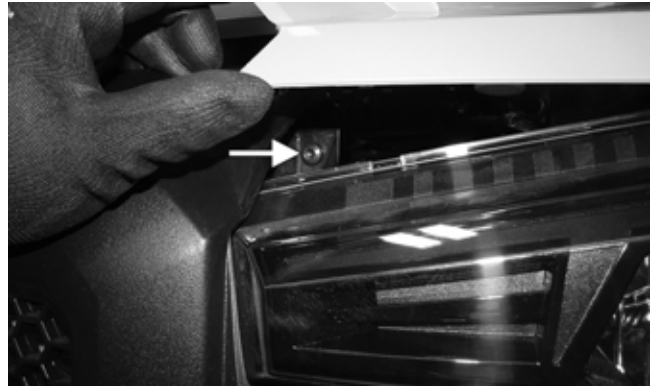

MODC071

4. Install the two cap screws securing the inner portion of the front fenders and the grille.



MODC054

5. Pour the recommended coolant into the coolant reservoir; then bleed the system (see Bleeding Cooling System in this section).

THERMOSTAT

Removing

1. Drain some coolant from the cooling system.
2. Remove the coolant hose from the thermostat housing



MOD551A

3. Located below the coils. Remove the two cap screws securing the thermostat housing.



MOD551C

4. Gently remove the thermostat housing away from the engine. Remove the thermostat. Account for the thermostat housing gasket.



MOD587

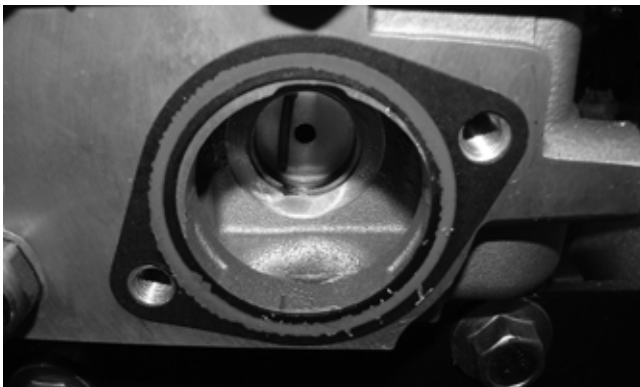

MOD586

Inspecting

1. Inspect the thermostat for corrosion, wear, or spring damage.
2. Using the following procedure, inspect the thermostat for proper operation.
 - A. Suspend the thermostat in a container filled with water.
 - B. Heat the water and monitor the temperature with a thermometer.
 - C. The thermostat should start to open at 83-87° C (181-189° F).
 - D. If the thermostat does not open, it must be replaced.
3. Inspect all coolant hoses, connections, and clamps for deterioration, cracks, and wear.

■NOTE: All coolant hoses and clamps should be inspected per the maintenance schedule.

Installing

1. Using a new thermostat housing gasket. Place the thermostat into the thermostat housing.

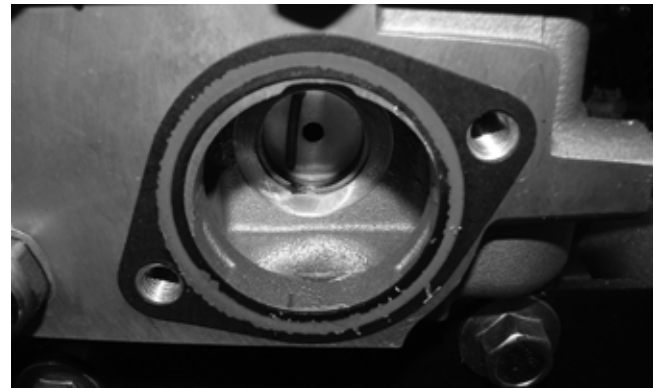

MOD586



MOD587

2. Install the two cap screws securing the thermostat housing and tighten to 15 ft-lb (20 N-m).



MOD551C

3. Install the coolant hose to the thermostat housing; then pour the recommended coolant into the coolant reservoir; then bleed the system (see Bleeding Cooling System in this section).



MOD551B

COOLING FAN

Removing

1. Disconnect the radiator fan electrical connection.



MOD474

2. Remove the four cap screws securing the fan to the radiator fan bracket; then remove the fan from the radiator.



MOD477

Installing

■NOTE: The fan wiring must be in the upper left position.

1. Position the fan assembly to the radiator; then install the four cap screws securing the fan to the radiator fan bracket.



MOD477

2. Connect the radiator fan electrical connection.

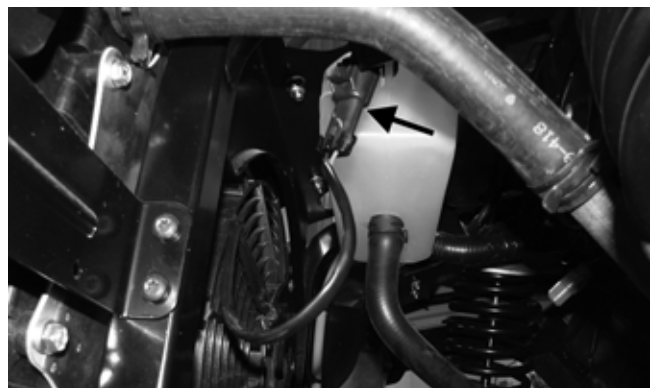

MOD474

WATER PUMP

■NOTE: The water pump is only serviceable as an assembly (see Engine section — Removing Cylinder Head and Related Components).

Troubleshooting

| Problem: Starting impaired | |
|--------------------------------------------------------|------------------------------------------------------------------------|
| Condition | Remedy |
| 1. Gas contaminated | 1. Drain gas tank and fill with clean gas |
| Problem: Idling or low speed impaired | |
| Condition | Remedy |
| 1. Throttle body out of sync | 1. Diagnose throttle body — Perform full verification on throttle body |
| Problem: Medium or high speed impaired | |
| Condition | Remedy |
| 1. Fuel pump obstructed — insufficient pressure | 1. Diagnose fuel pump — replace |

Electrical System

The electrical connections should be checked periodically for proper function.

TESTING ELECTRICAL COMPONENTS

All electrical tests should be made using the Dealer Diagnostic Service (computer connected), gauge diagnostic menu (a menu in the LCD gauge) or the Fluke Model 77 Multimeter. The Dealer Diagnostic Service can return data for certain components which are identified at the beginning of their respective sub-section. If any other type of meter is used, readings may vary due to internal circuitry. When troubleshooting a specific component, always verify first that the fuse(s) are good, the relay(s) are good, the LED(s) are good, the connections are clean and tight, the battery is fully charged, and that all appropriate switches are activated.

■NOTE: For absolute accuracy, all tests should be made at room temperature of 68° F (20° C).

■NOTE: Certain components and sensors can be checked by using the gauge diagnostic menu (see Gauge Diagnostic Menu in this section for more information).

SPECIAL TOOLS

A number of special tools must be available to the technician when performing service procedures in this section. Refer to the current Special Tools Catalog for the appropriate tool description.

■NOTE: When indicated for use, each special tool will be identified by its specific name, as shown in the chart below, and capitalized.

| Description | p/n |
|----------------------------|----------|
| Dealer Diagnostic Service | 0544-034 |
| Fuel Pump Wrench | 0444-310 |
| EFI Fuel Pressure Test Kit | 0644-587 |

■NOTE: Special tools are available from the Service Department.

Battery

Component data can be retrieved using the Dealer Diagnostic Service. Utilize the Sensor Data screen.

■NOTE: Preliminary checks may be performed on this component using the diagnostic menu in the LCD gauge (see Gauge Diagnostic Menu in this section).

The battery is located behind the passenger-side rear inner fender. When installing the battery, always connect the positive cable first; then connect the negative cable. When removing the battery, disconnect the negative cable first; then disconnect the positive cable.

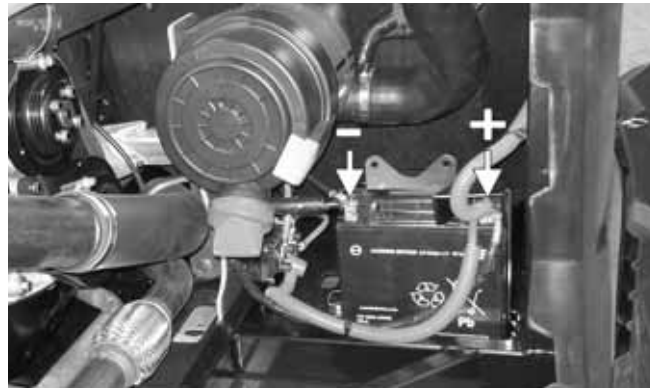

MOD010B

After being in service, batteries require regular cleaning and recharging in order to deliver peak performance and maximum service life. The following procedures are recommended for cleaning and maintaining lead-acid batteries. Always read and follow instructions provided with battery chargers and battery products.

■NOTE: Refer to all warnings and cautions provided with the battery or battery maintainer/charger.

Loss of battery charge may be caused by ambient temperature, ignition OFF current draw, corroded terminals, self discharge, frequent start/stops, and short engine run times. Frequent winch usage, snowplowing, extended low RPM operation, short trips, and high amperage accessory usage are also reasons for battery discharge.

Electronic Power Steering (EPS)

Component data can be retrieved using the Dealer Diagnostic Service. Utilize the Sensor Data screen.

The EPS system is an electro-mechanical device that utilizes 12-volt DC power to drive a motor linked to the steering shaft to assist the driver when rotating the steering wheel. Driver steering inputs are detected by a torque-sensing transducer assembly within the EPS housing. These inputs are converted to electronic signals by the transducer and control circuitry to tell the motor which way to drive the steering shaft. When no steering input (pressure on the steering wheel) is detected, no torque signal is generated, and no steering assist is provided by the motor.

If an electrical-related EPS system malfunction occurs, a diagnostic trouble code (DTC) will be displayed on the LCD gauge. Check for updates and verify any active DTCs using the most up-to-date CATT II Diagnostic Tool software. The following is a list of DTCs, possible conditions, and causes.

■NOTE: If no active codes are present on the LCD or verified through the Dealer Diagnostic Service and the vehicle is experiencing steering-related issues, there may be a mechanical steering-related issue. In this case, the EPS is not the cause of the issue. Components that may contribute to this type of issue could be abnormal tire wear, bad wheel bearings, ball joints, tie rod ends, tie rods, or bushings. Check the complete steering system for any sign of wear or misalignment.

■NOTE: If any codes are active and verified with the Dealer Diagnostic Service, EPS replacement is not always necessary. Follow the instructions listed in the chart to potentially correct the malfunction.

| Code | Fault Description | Fault Condition | Possible Cause | EPS Fault Recovery Method |
|-------|-----------------------------------|----------------------------------------------------------------------------------------------------------------|-----------------------------------------------------------------------------------------------------------------------------------------------------------|---------------------------------------------------------------------------------------------------------|
| C1351 | Motor Position Index | EPS internal motor position sensor condition has been detected. | Internal EPS condition; check for EPS software updates before replacing the EPS unit. | Correct EPS condition. Rotate steering left/right, key OFF for 10 seconds minimum, then key ON. |
| C1352 | Motor Position Plausibility | EPS internal motor position sensor condition has been detected. | Internal EPS condition; check for EPS software updates before replacing the EPS unit. | Correct EPS condition. Rotate steering left/right, key OFF for 10 seconds minimum, then key ON. |
| C1353 | Motor Position Range | EPS internal motor position sensor condition has been detected. | Internal EPS condition; check for EPS software updates before replacing the EPS unit. | Correct EPS condition. Rotate steering left/right, key OFF for 10 seconds minimum, then key ON. |
| C1354 | Internal Voltage Supply | EPS internal voltage supply condition has been detected. | Internal EPS condition; check for EPS software updates before replacing the EPS unit. | Correct the internal voltage supply condition, key OFF for 10 seconds minimum, then key ON. |
| C1355 | Session Error | EPS power condition has been detected. | System voltage variations. Wire harness issue, faulty voltage regulator, weak battery or loose battery terminals. | Correct the power supply condition, key OFF for 10 seconds minimum, then key ON. Check for EPS updates. |
| C1356 | Torque Sensor Open Circuit | EPS internal torque sensor condition has been detected. | Internal EPS condition; check for EPS software updates before replacing the EPS unit. | Correct the internal torque sensor condition, key OFF for 10 seconds minimum, then key ON. |
| C1357 | Torque Sensor Range | EPS internal torque sensor condition has been detected. | Check for electrical/magnetic interference around the steering system. Verify all steering components move freely. | Correct the steering interference, perform torque reset, key OFF 10 seconds minimum, then key ON. |
| C1358 | Torque Sensor Over Range | EPS internal torque sensor condition has been detected. | Check for electrical/magnetic interference around the steering system. Verify all steering components move freely. | Correct the steering interference, perform torque reset, key OFF 10 seconds minimum, then key ON. |
| C1359 | Torque Sensor Communication | EPS internal torque sensor condition has been detected. | Internal EPS condition; check for EPS software updates before replacing the EPS unit. | Correct the internal torque sensor condition, key OFF for 10 seconds minimum, then key ON. |
| C1360 | Internal Processor Error | EPS internal processor condition has been detected. | Internal EPS condition; check for EPS software updates before replacing the EPS unit. | Correct the internal processor condition, key OFF for 10 seconds minimum, then key ON. |
| C1361 | Temperature Sensor Circuit | EPS internal over-temp or out-of-spec condition has been detected. | Clean the EPS housing and cooling fins. | EPS will auto-recover when internal temperature returns to normal. |
| C1362 | Stuck at Bootloader | EPS internal application code CRC calculation condition has been detected. | EPS reflash has failed. Battery power was lost or the key switch was turned off during EPS reflash programming. Service unit has not been programmed yet. | EPS must be reprogrammed. |
| C1363 | Calibration Values Not Programmed | Internal EPS calibration value condition has been detected. | Internal EPS condition; check for EPS software updates before replacing the EPS unit. | Perform an EPS software reflash, key OFF for 10 seconds minimum, then key ON. |
| C1364 | Calibration Checksum | EPS internal calibration code condition has been detected. | EPS reflash has failed. Battery power was lost, or the key switch was turned off, during EPS reflash programming. | EPS must be reprogrammed. |
| C1365 | Application Checksum | EPS internal application code condition has been detected. | EPS reflash has failed. Battery power was lost or the key switch was turned off during EPS reflash programming. | EPS must be reprogrammed. |
| C1366 | Variant Coding Error | EPS internal software code condition has been detected. | Confirm EPS model number matches the vehicle model. Check for EPS software updates before replacing the EPS unit. | Perform an EPS software reflash, key OFF for 10 seconds minimum, then key ON. |
| C1367 | Vehicle Speed | Based on engine RPM and gear position, the EPS has detected an incorrect or missing vehicle speed CAN message. | Broken main harness CAN wires, defective speed sensor, or broken speed sensor wires. | EPS will auto-recover when the vehicle speed signal returns to normal. |
| C1368 | ECM CAN Bus Error | EPS to ECM CAN Bus communication condition has been detected. | Broken main harness CAN wires or intermittent CAN connector connections. | Correct the CAN BUS Error condition, key OFF for 10 seconds minimum, then key ON. |
| C1369 | Gauge CAN Bus Error | The gauge has lost CAN communication with the EPS. | Broken main harness CAN wires or intermittent CAN connector connections. | Correct the CAN BUS Error condition, key OFF for 10 seconds minimum, then key ON. |
| C1370 | CAN Bus Error | EPS CAN Bus communication condition has been detected. | Broken main harness CAN wires or intermittent CAN connector connections. | Correct the CAN BUS Error condition, key OFF for 10 seconds minimum, then key ON. |
| C1371 | Over Temp Condition | EPS internal over-temp condition has been detected. | Clean the EPS housing and cooling fins. | EPS will auto-recover when internal temperature returns to normal. |
| C1372 | Battery Voltage Low | EPS power low-voltage condition has been detected. | System voltage is low (less than 11 VDC at the EPS). Wire harness issue, faulty voltage regulator, weak battery or loose battery terminals. | EPS will auto-recover when the battery supply returns to normal. |
| C1373 | Battery Voltage High | EPS battery power over-voltage condition has been detected. | System voltage is high (more than 16 VDC at the EPS). Wire harness issue, faulty voltage regulator or loose battery terminals. | EPS will auto-recover when the battery supply returns to normal. |
| C1374 | Over Current Error | An EPS internal over-current condition has been detected. | Internal EPS condition. | Correct the EPS condition, then cycle the key switch ON-OFF-ON. |
| C1375 | System Voltage High | EPS battery power over-voltage condition has been detected. | System voltage is high (more than 16 VDC at the EPS). Wire harness issue, faulty voltage regulator or loose battery terminals. | Correct the High System Voltage condition, key OFF for 10 seconds minimum, then key ON. |
| C1376 | Current Sensor Range | EPS internal current sensor condition has been detected. | Internal EPS condition; check for EPS software updates before replacing the EPS unit. | Correct the internal current sensor condition, key OFF for 10 seconds minimum, then key ON. |

TROUBLESHOOTING

■NOTE: The EPS assembly is not serviceable and must not be disassembled or EPS warranty will be voided.

1. Check 30-amp EPS fuse.

■NOTE: There are three black terminals and three orange/black terminals that are connected to their respective colors.

2. With the ignition off, disconnect 10-pin connector on the EPS assembly and connect a voltmeter set to DC voltage to the harness (black meter lead to BLK and red meter lead to ORG/BRN). With the ignition switch in the ON position, the meter should read battery voltage (if correct voltage is not present, check connections and wiring harness).

CAUTION

Do not attempt to check resistance of the EPS motor. There are internal capacitors holding a charge that can cause internal damage to an ohmmeter.

3. With ignition switch off, disconnect the 10-pin connector on the EPS assembly and connect a voltmeter set to DC voltage to the harness (red meter lead to the ORG wire and black meter lead to battery ground.) With the ignition switch in the ON position, the meter should read battery voltage (if correct voltage is not present, check for loose fittings or connections in the wiring harness).

CAUTION

If the Dealer Diagnostic Service has confirmed an active DTC relating to the CAN communication wires, use extreme caution when testing the wires. Do not probe the ECM connector with meter leads; instead use a small T-pin or other suitable testing component to make light and proper contact.

CAUTION

Never disconnect the ECM connector with the battery cables installed onto the battery.

■NOTE: If the preceding tests and possible solutions produce normal results, and an EPS issue persists with active DTCs confirmed by the Dealer Diagnostic Service, the EPS assembly must be replaced (see Steering/Body/Controls).

Ignition Switch

The ignition switch, dash switches, front accessory connectors, and front switched accessory connector can be accessed from under the dash or by pulling out the LCD gauge.

VOLTAGE

■NOTE: Perform this test on the harness connector.

1. Set the meter selector to the DC Voltage position.

2. Connect the red meter lead to the red wire; then connect the black meter lead to battery ground.
3. Meter must show battery voltage.

■NOTE: If the meter shows no battery voltage, troubleshoot the main 30-amp fuse, the battery, or the main wiring harness.

4. Connect the red meter lead to the brown/black wire; then with the black lead grounded, turn the ignition switch to the ON position. The meter must show battery voltage.
5. Connect the red meter lead to the yellow/green wire; then with the black lead grounded, turn the ignition switch to the START position. The starter should engage and the meter must show battery voltage.

■NOTE: When the starter is engaged, battery voltage will be approximately 10.5 DC volts.

Ignition Coils

The ignition coils are located on the driver-side of the cylinder head above the thermostat housing.

VOLTAGE

Primary Coils

1. Set the meter selector to the DC Voltage position.
2. Connect the red tester lead to the orange wire and the black tester lead to ground.
3. Turn the ignition switch to the ON position. The meter must show battery voltage.

Secondary Coils

CAUTION

Disconnect the injector connectors before performing the following procedure.

1. Connect the primary ignition coil connector. Remove the spark plug cap from the spark plug.
2. Connect the spark plug cap to an ignition test plug or other suitable tool; then ground the tool away from the spark plug hole. While turning the engine over, check for sufficient spark.

RESISTANCE

CAUTION

Always disconnect the battery when performing resistance tests to avoid damaging the multimeter.

Primary Winding

1. Remove the connector from the ignition coil; then set the meter selector to the OHMS position.
2. Connect the red tester lead to one terminal; then connect the black tester lead to the other terminal.

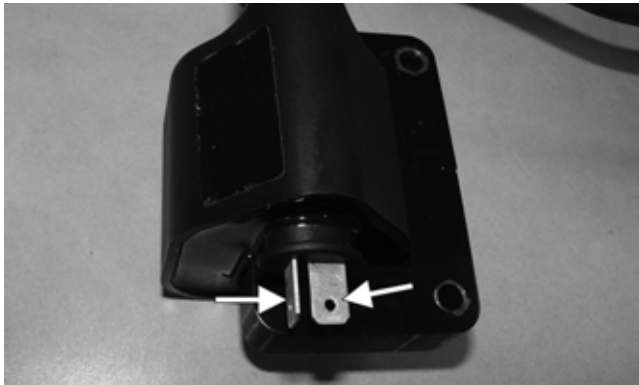

MOD580

3. The meter reading must be less than 1 ohm.

■NOTE: Secondary coil resistance checks are not recommended. An internal diode in the coil prevents accurate secondary resistance measurements.

Spark Plug Cap

1. Remove the spark plug cap from the spark plug; then remove the spark plug wire from the ignition coil.
2. Set the meter selector to the OHMS position.
3. Connect one meter lead to the spark plug end and then connect one meter lead to the ignition coil end.



MOD581

4. The meter must show approximately 5,000 ohms.

Accessory Receptacle/ Connector

■NOTE: This test procedure is for either the receptacles or the connectors.

VOLTAGE (Switched)

1. Turn the ignition switch to the ON position; then set the meter selector to the DC Voltage position.

■NOTE: There are three black terminals and three orange/black terminals that are connected to their respective colors.

2. Connect the red tester lead to the orange/black wire; then connect the black tester lead to ground.
3. The meter must show battery voltage.

■NOTE: If the meter shows no battery voltage, troubleshoot the battery, SW. ACC fuse, SW. ACC relay, receptacle, connector, or the main wiring harness.

VOLTAGE (Constant)

1. Set the meter selector to the DC Voltage position.
2. Connect the red tester lead to the red/white wire; then connect the black tester lead to ground.
3. The meter must show battery voltage.

■NOTE: If the meter shows no battery voltage, troubleshoot the battery, fuse, receptacle, connector, or the main wiring harness.

Switches

SEAT BELT LIMITER

■NOTE: This vehicle is equipped with a speed limitation device to limit the speed if the driver's seat belt is not fully engaged. The seat belt indicator light will remain illuminated until the driver's seat belt is fully engaged.

Resistance

1. Set the meter to the OHMS position.
2. Remove the driver-side rear inner fender. Locate the switch connector above the fuel tank; then disconnect.



MOD483

3. Buckle the driver's seat belt. On the switch side of the connector, connect one meter lead to one pin and the other meter lead to the opposite connector pin.



MOD485

4. Meter reading should show less than 1 ohm.
5. Release the seat belt latch from the buckle, with the meter leads still connected to the pins. Meter reading should show OL.

■NOTE: If the meter readings are OL or greater than 1 ohm with the seat belt buckled, replace the buckle switch assembly. If the resulting readings from step 5 are not OL, replace the buckle switch assembly.

Voltage

1. Set the meter selector to the DC Voltage position
2. On the harness side of the switch connector, connect the red meter lead to the orange wire and the black meter lead to the tan wire.
3. With the ignition switch in the ON position, the meter should show battery voltage.

■NOTE: If voltage is not present, check the 10-amp power fuse, battery/battery connections, or related wires in the battery circuit.

Removing

To replace the switch, the driver's side buckle assembly must be replaced. As the switch is incorporated into the assembly.

1. Remove the driver's seat and the center passenger seat base.
2. Remove the cap screw and lock nut securing the buckle cable to the frame. Discard lock nut and cap screw.



MOD612

3. Disconnect the switch connector from the switch and remove any nylon straps securing the switch.

Installing

1. Place the new buckle assembly into position; then secure using a new cap screw and new lock nut. Tighten to 60 ft-lb (81.6 N-m).
2. Connect the switch and secure to the frame; then install the driver's seat and center passenger seat base.



MOD483

BRAKE LIGHT

Component data can be retrieved using the Dealer Diagnostic Service. Utilize the Sensor Data screen.

■NOTE: There are two brake switches on the master cylinder. The frontmost brake switch is a 12-volt DC circuit switch and is connected to the front brakes. The rearmost brake switch is a switch-to-ground circuit and is connected to the rear brakes.

Voltage

Master Cylinder Frontmost Brake Switch

Remove the mid/upper dashboard and lower dashboard to access the front wires and switch.

■NOTE: The ignition switch must be in the ON position.

1. Set the meter selector to the DC Voltage position.
2. Connect the red tester lead to the orange wire; then connect the black tester lead to battery ground.

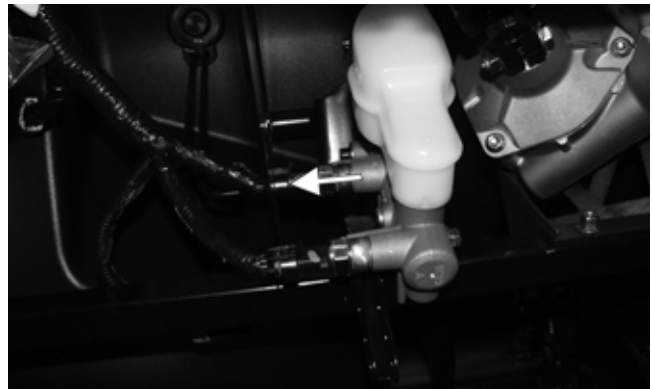

MOD568

3. The meter must show battery voltage.

■NOTE: If the meter shows no battery voltage, troubleshoot the battery, fuse, switch, or the main wiring harness.

■NOTE: If the meter shows battery voltage, the main wiring harness is good; proceed to test the switch/component, the connector, and the switch wiring harness for resistance.

Resistance

CAUTION

Always disconnect the battery when performing resistance tests to avoid damaging the multimeter.

■NOTE: There are two brake switches on the master cylinder. The frontmost brake switch is a 12-volt DC circuit switch and is connected to the front brakes. The rearmost brake switch is a switch-to-ground circuit and is connected to the rear brakes.

■NOTE: The brake pedal must be depressed for this test.

1. Set the meter selector to the OHMS position. Remove the connectors from the switches.
2. Connect the red tester lead to one terminal spade; then connect the black tester lead to the other terminal spade.

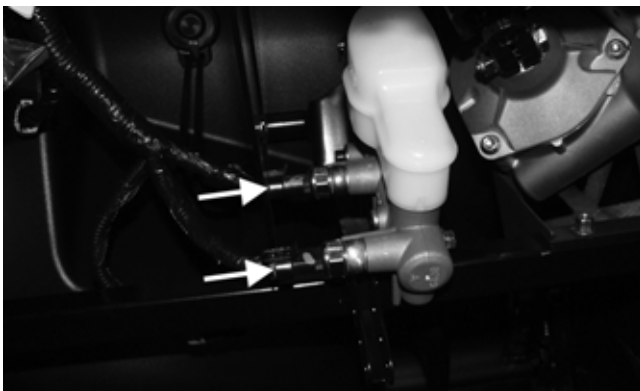

MOD568A

3. When the lever is depressed, the meter must show less than 1 ohm; then repeat for other brake switch.

■NOTE: If the meter shows more than 1 ohm of resistance, replace the switch.

DRIVE SELECT

Resistance

Component data can be retrieved using the Dealer Diagnostic Service. Utilize the Sensor Data screen.

1. Remove the switch assembly from the dash; then disconnect the harness from the switch.

■NOTE: The switch can be removed from the dash using a thin, flat pry bar or suitable putty knife. It is not necessary to remove the dash to remove the switch.

2. Set the meter selector to the OHMS position, the following readings must be observed.

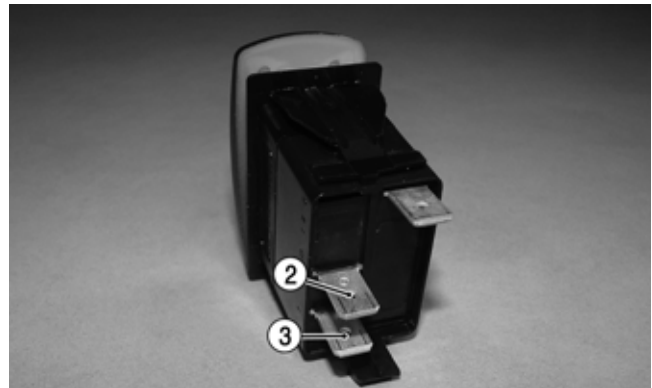

MOD486

| 2WD/4WD Switch | |
|----------------|---------------|
| 2WD | 4WD |
| 2 to 3 Open | 2 to 3 <1 ohm |

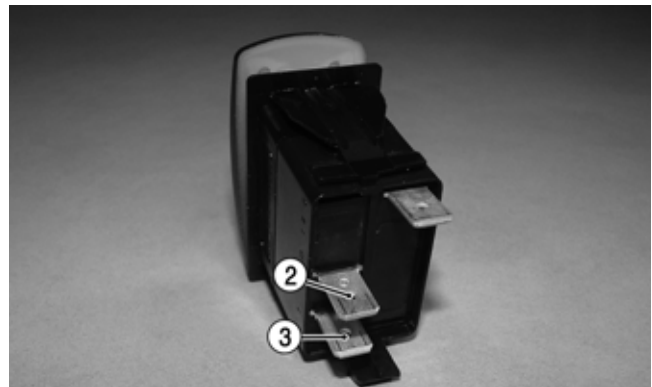

MOD486

| REAR UNLOCK/LOCK Switch | |
|-------------------------|---------------|
| UNLOCK | LOCK |
| 2 to 3 Open | 2 to 3 <1 ohm |

Voltage

■NOTE: Voltage tests must be made with the switches and the actuator connected. The meter can be connected at the actuator connector using a break-out harness or MaxiClips. The front drive actuator must be connected.

1. Connect the black tester lead to the black wire; then turn the ignition switch to the ON position.
2. Select the DC Volts position on the tester and observe the meter readings for each switch positions.

| WIRE COLOR | 2WD/4WD Switch | |
|--------------------|----------------|---------------|
| | 2WD | 4WD |
| Red to Orange/Gray | 12.0 DC Volts | 12.0 DC Volts |
| Red to White/Green | 11.5 DC Volts | 0 DC Volts |

| WIRE COLOR | REAR LOCK/UNLOCK Switch | |
|----------------------|-------------------------|---------------|
| | UNLOCK | LOCK |
| Red to Orange/Gray | 12.0 DC Volts | 12.0 DC Volts |
| Red to Yellow/Orange | 11.5 DC Volts | 0 DC Volts |

■NOTE: If the meter does not show voltages according to the chart, make sure the front drive actuator is plugged in; then troubleshoot the switches, ignition fuses, battery connections, or wiring harness.

Fan Motor

Component data can be retrieved using the Dealer Diagnostic Service. Utilize the Sensor Data screen.

■NOTE: Preliminary checks may be performed on this component using the diagnostic mode on the LCD gauge (see Gauge Diagnostic Menu in this section).

■NOTE: To determine if the fan motor is good, connect the blue wire from the fan connector to the positive side of a 12-volt battery; then connect the black wire from the fan connector to the negative side. The fan should operate.



MOD474

WARNING

Care should be taken to keep clear of the fan blades.

■NOTE: Fan motor resistance checks are not recommended. Resistance values change with the motor commutator position.

Lights

HEADLIGHTS

Voltage

Each headlight has one HI/LO three-pin connector.

■NOTE: The HI/LO bulb-connector uses a three-pin connector with the corresponding color codes: white, yellow/black, and black.

1. Behind the headlight remove the connector from the headlight; then set the meter selector to the DC Voltage position.

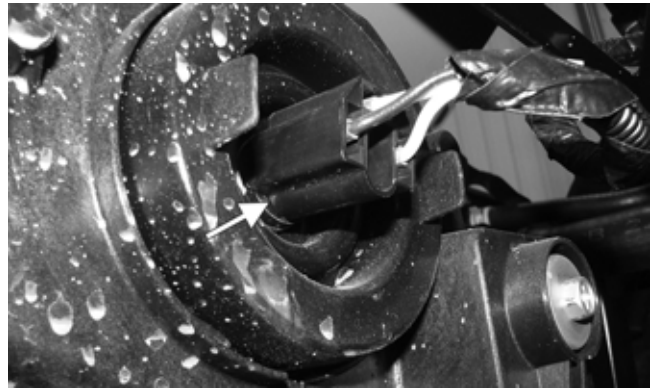

MOD498

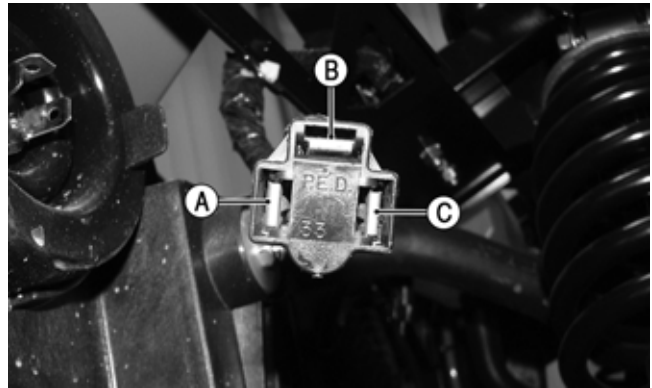

MOD497

2. Connect the black meter lead to the black wire (C); then connect the red meter lead to the white wire (B); then turn the key switch to the ON position and turn the light switch to LO-BEAM. Voltage must be present. If no voltage is present, troubleshoot the LO-BEAM fuse, or lights switch.
3. Connect the black meter lead to the black wire (C); then the red meter lead to the yellow/black wire (A); then turn the key switch to the on position and turn the light switch to HI-BEAM. Voltage must be present. If no voltage is present, troubleshoot the HI-BEAM fuse, or lights switch.

■NOTE: If both HI-BEAM and LO-BEAM have no voltage check the lights relay, main fuse, lights switch, battery connections, or wiring harness.

Resistance

1. Remove the plug from the center of the light switch; then remove the screw underneath where the plug was; then remove the nut securing the light switch to the dash; then remove the switch assembly from the backside of the dash; then disconnect the harness from the switch.

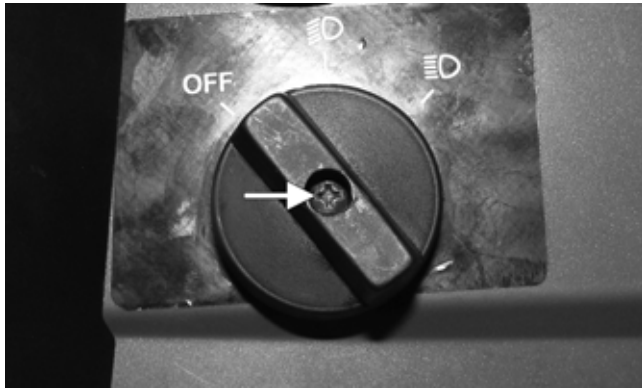

MOD496

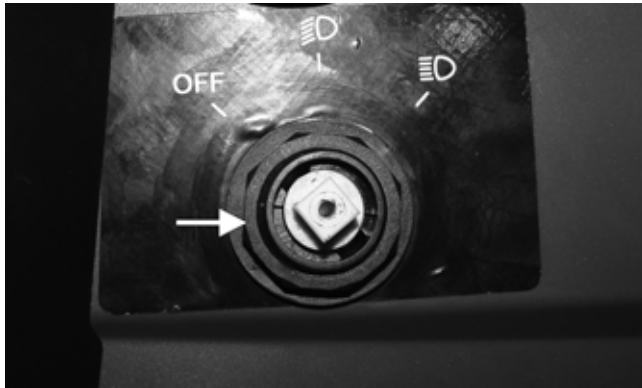

MOD497

2. Set the meter selector to the OHMS position. The following readings must be observed:

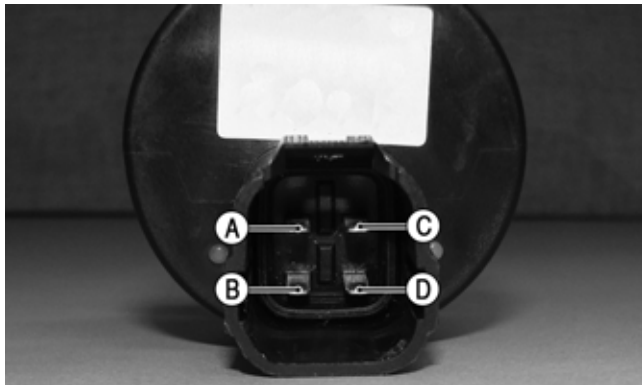

MOD487

| LIGHT Switch | | | | |
|--------------|--------|--------|--------|--------|
| | A | B | C | D |
| OFF | Open | Open | Open | Open |
| LO-BEAM | <1 ohm | <1 ohm | Open | <1 ohm |
| HI-BEAM | <1 ohm | <1 ohm | <1 ohm | Open |

TAILLIGHT

Voltage

■NOTE: Perform this test at the socket end of the taillight-brake light harness (pigtail). The ignition switch must be in the ON position and either HI-BEAM or LO-BEAM selected on the light switch.

1. Set the meter selector to the DC Voltage position.
2. Connect the black tester lead to the black wire; then connect the red tester lead to the white/red wire.
3. With the ignition key in the on position, the meter must show battery voltage.

■NOTE: If battery voltage is not shown and the headlights are illuminated, inspect the Lights fuse. If battery voltage is shown on the meter, replace the bulb.

BRAKE LIGHT

Voltage

■NOTE: Perform this test at the socket end of the taillight-brake light harness (pigtail). The ignition switch must be in the ON position.

1. Set the meter selector to the DC Voltage position.
2. Connect the red tester lead to the red/blue wire; then connect the black tester lead to the black wire.
3. With the brake applied, the meter must show battery voltage.

■NOTE: If the meter shows no voltage, inspect the 10-amp lights fuse, brake light switch, wiring harness, or connectors.

Power Distribution Module (PDM)

■NOTE: The module and wiring harness are only serviceable as assemblies.

If there is any type of electrical system failure, always check the fuses first.

■NOTE: The fuses are located in two power distribution modules (PDM) under the hood.

1. Remove all fuses from the power distribution modules.

■NOTE: To remove a fuse, compress the locking tabs on either side of the fuse case and lift up.

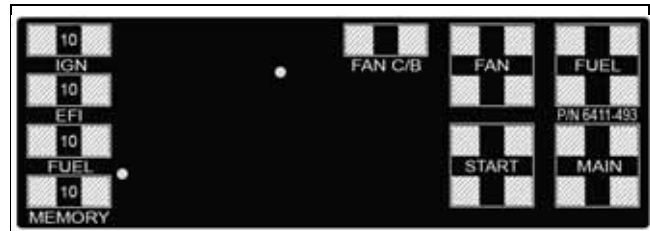

6411-493

CAUTION

Always replace a blown fuse with a fuse of the same type and rating.

■NOTE: Make sure the fuses are returned to their proper position according to amperage. Refer to the amperage listed under each fuse on the power distribution module.

2. Set the meter selector to the DC Voltage position.
3. Connect the black tester lead to battery ground.
4. Using the red tester lead, contact each end of the fuse holder connector terminals individually.

5. The meter must show battery voltage from one side of the connector terminal ends.

■NOTE: Battery voltage will be indicated from only one side of the fuse holder connector terminal; the other side will show no voltage.

■NOTE: When testing the HI fuse holder, the headlight OFF/LO/HI switch must be in the HI position; when testing the LIGHTS fuse holder, the headlight dimmer switch can be in either the HI or the LO position.

■NOTE: If the meter shows no battery voltage, troubleshoot the battery, switches, PDM, or the main wiring harness.

RELAYS

The 4-pin relays are identical plug-in type located on the power distribution module. Relay function can be checked by switching relay positions. The 4-pin relays are interchangeable.

EFI Sensors/Components

THROTTLE BODY

Component data can be retrieved using the Dealer Diagnostic Service. Utilize the Sensor Data screen.

■NOTE: Throttle position sensor values are visible in the diagnostic menu of the gauge.

■NOTE: A multimeter cannot be used to diagnose the throttle body.

■NOTE: The throttle body is only serviceable as an assembly.

There are two throttle position sensors for the throttle body. If one sensor fails, the vehicle will have a code(s) that will appear and the engine will be RPM limited until the issue is fixed.

There is no learn mode that is specific to throttle body replacement. When the key is switched to the ON position, the throttle body will quickly verify proper movement. If the key is switched on and left on for 15 seconds or more without starting the engine, the throttle body will go through a full verification process that will be completed once the throttle body stops making noise.

■NOTE: If there are any types of idle or run quality issues, allow the throttle body to go through the full verification process by leaving the key switched on and left for a minimum of 15 seconds without starting the engine. The full verification process is completed when the throttle body stops making noise.

■NOTE: The throttle body will not go through the full verification process if the temperature is below 32° F (0° C).

⚠ WARNING

Short tripping this vehicle in freezing temperatures or rapid hot/freezing cycles may allow ice to form in the throttle body that can cause run issues. This possibility can be greatly reduced if the engine is allowed to always come to full running temperature when used in below freezing (32° F or 0° C) conditions.

THROTTLE PEDAL

■NOTE: Throttle pedal values are visible in the diagnostic menu of the gauge.

■NOTE: The throttle body is only serviceable as an assembly.

There are two throttle sensors for the throttle pedal. If one sensor fails, the vehicle will have a code(s) that will appear and the engine will be RPM limited until the issue is fixed.

The pedal can come apart, but will not go back together. There is no learn mode for throttle pedal replacement. The throttle pedal sends a 0-100% signal to the ECM.

FUEL INJECTORS

Component data can be retrieved using the Dealer Diagnostic Service. Utilize the Sensor Data screen.

Voltage

1. Remove the connector from the fuel injector. Set the meter selector to the DC Voltage position.
2. Place the red meter lead to the orange wire and black meter lead to ground.
3. With the ignition switch in the ON position, the meter must read battery voltage.

■NOTE: If voltage is not present, troubleshoot the battery, connector pins, wiring harness, fuses, or relay.

Resistance

1. With the connector still removed from the injector, set the meter selector to the OHMS position
2. Connect the red tester lead to either terminal on the injector; then connect the black tester lead to the other terminal on the injector.



MOD584

3. Reading is typically 14.7 ohms.

NOTE: If resistance is not present or largely out of specification, replace the injector.

CRANKSHAFT POSITION (CKP) SENSOR

Resistance

1. Disconnect the crankshaft position sensor. Set the meter selector to the OHMS position.
2. Connect the red tester lead to one of the terminals indicated on the sensor side; then connect the black tester lead to one of the terminals indicated on the sensor side.



MOD582

3. The meter reading must be 774-946 ohms at 20° C (68° F).

AC Voltage

NOTE: The battery must be at full charge for these tests.

1. Disconnect the fuel pump; then set the meter selector to the AC Voltage position.
2. Connect the red tester lead to the brown/green wire; then connect the black tester lead to the green/white wire.
3. Crank the engine over using the electric starter.
4. The meter reading must be approximately 3.5 volts or more.

OXYGEN (O2) SENSOR

Component data can be retrieved using the Dealer Diagnostic Service. Utilize the Sensor Data screen.

The Oxygen Sensor (O2 Sensor) is located in the exhaust pipe.

NOTE: When testing the resistance of the sensor's heater, the engine/exhaust pipe must be at room temperature (65-75° F or 18-24° C) or inaccurate readings will occur.

1. Tilt the cargo box up.
2. Disconnect the oxygen sensor that is located on the front side of the engine.

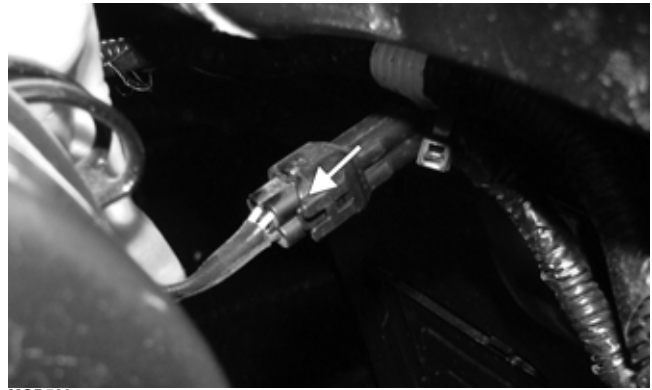

MOD583

3. Set the meter selector to the OHMS position.
4. On the sensor side of connector, connect the black (negative) test lead to one white wire pin; then connect the red (positive) test lead to the other white wire pin. The reading is typically 15.9 ohms.

NOTE: If the meter does not read as specified, replace the sensor.

TEMPERATURE/MANIFOLD ABSOLUTE PRESSURE (TMAP) SENSOR

Component data can be retrieved using the Dealer Diagnostic Service. Utilize the Sensor Data screen.

NOTE: Preliminary checks may be performed on this component using the diagnostic mode on the LCD gauge (see Gauge Diagnostic Menu in this section).

1. Disconnect the connector from the sensor located on top of the intake.



MOD585

2. Select DC Voltage on the tester and turn the ignition switch to the ON position.
3. Connect the black tester lead to the black/blue wire and the red tester lead to the pink/violet wire. The meter should read 4.5-5.5 DC volts. If the meter does not read as specified, check the ECM connector or wiring.

ENGINE COOLANT TEMPERATURE (ECT) SENSOR

Component data can be retrieved using the Dealer Diagnostic Service. Utilize the Sensor Data screen.

NOTE: Preliminary checks may be performed on this component using the diagnostic mode on the LCD gauge (see Gauge Diagnostic Menu in this section).

1. Disconnect the connector from the sensor located below the thermostat housing; then remove the engine coolant temperature (ECT) sensor.

■NOTE: When removing sensor coolant will come out.

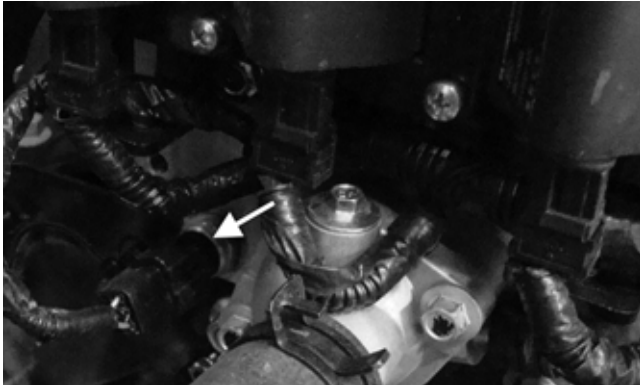

MOD556A

2. Set the meter selector to the OHMS position; then connect one lead to an outer spade terminal; then connect the other lead to the other outer spade terminal; then suspend the sensor and a thermometer in a container of cooking oil; then heat the oil.

■NOTE: Neither the sensor nor the thermometer should be allowed to touch the bottom of the container or inaccurate readings will occur. Use wire holders to suspend the sensor and thermometer.

⚠ WARNING

Wear insulated gloves and safety glasses. Heated oil can cause severe burns.

3. If the readings are not approximately as indicated, the sensor must be replaced.

| OIL TEMPERATURE | OHMS |
|-----------------|-----------|
| 20° C (68° F) | 2270-2640 |
| 100° C (212° F) | 183.6 |
| 150° C (302° F) | 70.2 |

4. Install the sensor and tighten securely; then connect the leads.

ENGINE OIL PRESSURE SWITCH

The switch is normally closed when the engine is not running or does not have sufficient oil pressure. The switch becomes open at approximately 4.35-7.25 psi (30-50 kPa).

1. Disconnect the connector from the engine oil pressure switch located next to the valve cover.

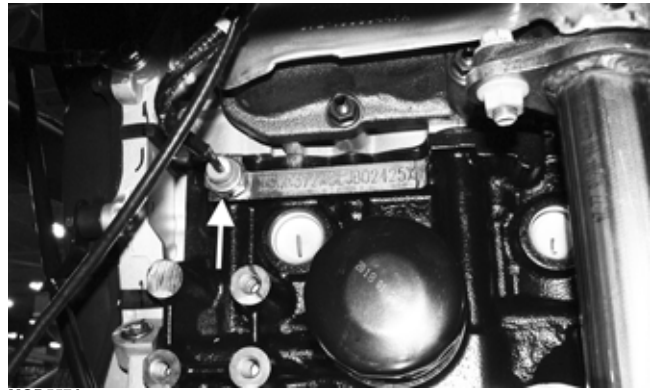

MOD557A

2. Set the meter selector to the OHMS position; then connect the red tester lead to the pin inside the switch and the black tester lead to a ground. The switch should have less than 1 ohm of resistance.
3. Start the engine. The switch should now be open and the multimeter should read OL. If the switch does not open, verify engine oil pressure is greater than 4.35-7.25 psi (30-50 kPa). If engine oil pressure is greater than 4.35-7.25 psi (30-50 kPa), replace the engine oil pressure switch.

SPEED SENSOR

■NOTE: Prior to testing the speed sensor, inspect the three-wire connector on the speed sensor for contamination, broken pins, and/or corrosion.

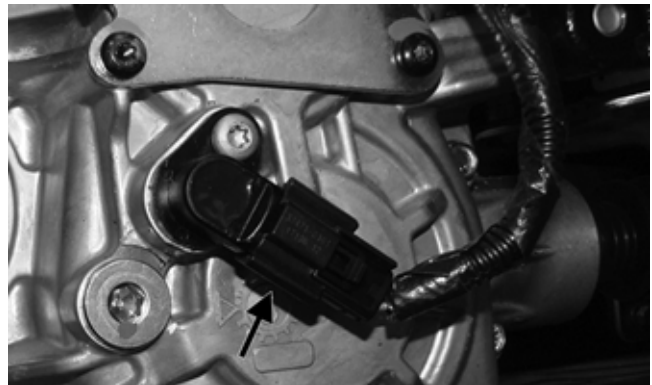

MOD488

Testing

1. Set the meter selector to the DC Voltage position.
2. With appropriate needle adapters on the meter leads, connect the red tester lead to the orange wire; then connect the black tester lead to the black wire.
3. Turn the ignition switch to the ON position.
4. The meter will typically show battery voltage.
5. Leave the black tester lead connected; then connect the red tester lead to the pink/white wire.
6. Slowly move the vehicle forward or backward; the meter must show 0 and battery voltage alternately.

Replacing

1. Disconnect the three-wire connector from the speed sensor; then remove the cap screw securing the sensor to the sensor housing.

- Remove the sensor from the sensor housing accounting for an O-ring.
- Install the new speed sensor into the housing with a new O-ring lightly coated with multi-purpose grease; then secure the sensor with the cap screw (threads coated with blue Loctite #242). Tighten securely.

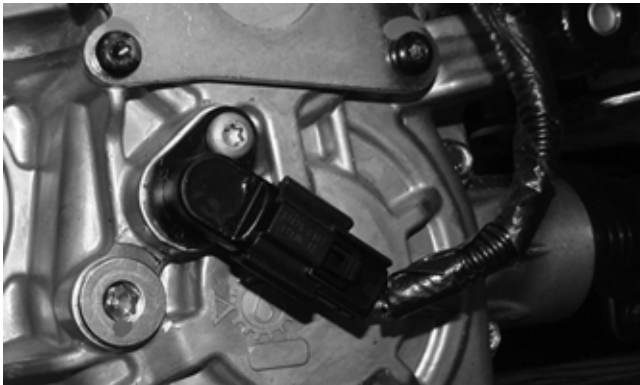

MOD488A

FUEL PUMP/FUEL LEVEL SENSOR

Component data can be retrieved using the Dealer Diagnostic Service. Utilize the Sensor Data screen.

■NOTE: The fuel pump and fuel level sensor are only serviceable as assemblies.

Testing

⚠ WARNING

Whenever any maintenance or inspection is made on the fuel system during which there may be fuel leakage, there should be no welding, smoking, open flames, etc., in the area.

👉 AT THIS POINT

Prior to removing the electric fuel pump, the following check should be performed to determine that removal is necessary.

- Turn the ignition switch ON and listen for a momentary “whirring” sound of the pump building pressure. If the sound is heard (several seconds), no electrical checks are necessary. Turn the ignition switch OFF.

⚠ WARNING

Fuel may be under pressure. De-pressurize the fuel system by disconnecting the fuel pump electrical connector (A) and running the engine until it stalls. Place an absorbent towel around the connector to absorb any fuel when disconnecting.

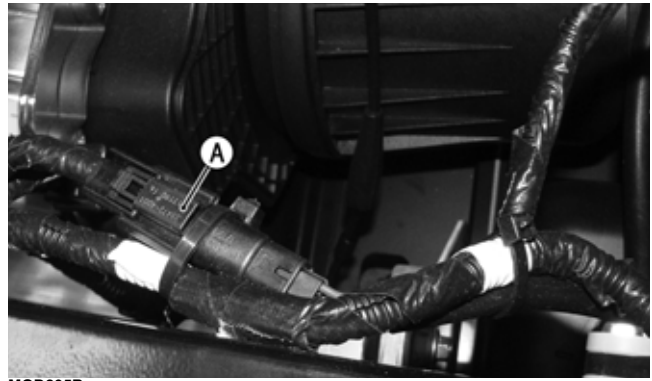

MOD295B

- Disconnect the fuel hose (B) from the fuel pump; then install the EFI Fuel Pressure Test kit.

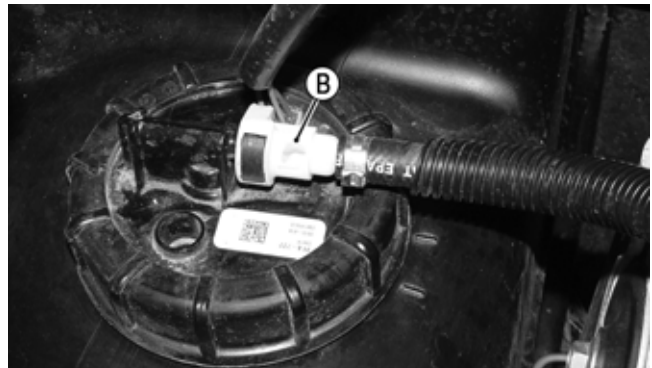

MOD566

- Reconnect the fuel pump electrical connector (A); then turn the ignition switch to the ON position. The fuel pressure should build until the pump shuts off. Pressure should read 3.0 kg-cm² (43.5 psi).
- If the pump is not running, disconnect the fuel pump/sensor connector (A).
- Connect a multimeter to the power supply leads with the red tester lead to the orange/red wire and the black tester lead to the black wire; then turn the ignition switch to the ON position. The meter should read battery voltage. If battery voltage is indicated and the fuel pump does not run, replace the pump assembly. If no battery voltage is indicated, check the ECM, fuel relay, fuse, and the vehicle tilt sensor.

Removing Fuel Pump Assembly

- Remove the key from the ignition switch.

⚠ WARNING

Always ensure that power cannot be inadvertently applied to the ignition/ECM when working on the fuel system. If the ignition switch is turned on, the electric fuel pump will start and gas could be rapidly pumped and spilled resulting in fire and severe injury.

- Tilt the cargo box up; then remove the driver-side rear inner fender; then remove the CVT cover; then disconnect the negative battery cable.
- Disconnect the electrical plug (A) from the main harness; then disconnect the fuel hose (B) from the fuel pump.



MOD295B

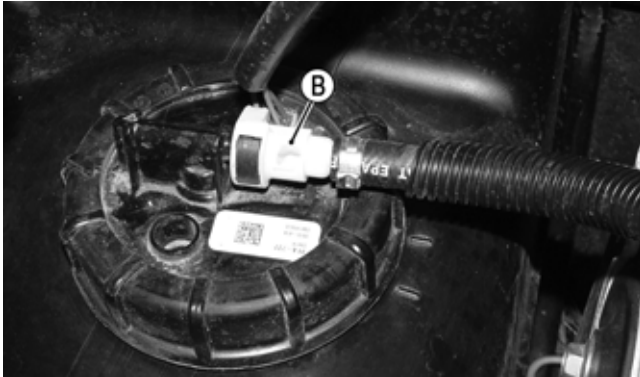

MOD566

4. Mark the fuel pump mounting and gas tank for installing purposes; then using a suitable tool, remove the fuel tank nut securing the fuel pump to the gas tank and remove the fuel pump.

CAUTION

Take care not to damage the float or float arm or replacement of the entire assembly will be necessary.

5. Using duct tape or other suitable means, cover the fuel pump opening.

Inspecting

👉 AT THIS POINT

If the pump has failed earlier test and must be replaced, proceed to **INSTALLING**.

1. Inspect the fuel screen and blow clean with low pressure compressed air.
2. Move the float lever and check for free movement. The float assembly should return to the lower position without force.
3. Test the fuel level sensor by connecting a multimeter (A) to the fuel level sensor leads (B); then select OHMS. The multimeter should show 5 ohms at full fuel position (C) and 95 ohms at empty fuel position (D).

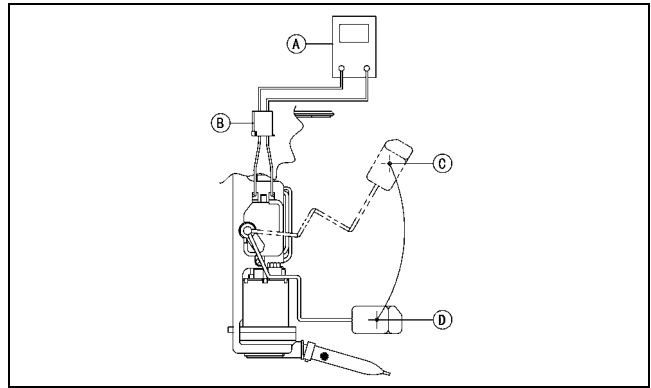

ATV2116

■NOTE: If readings are erratic, clean the resistor wiper and resistor with clean alcohol and retest. If still not correct, replace the fuel pump assembly.

Replacing Fuel Level Sensor

To replace the fuel level sensor, use the following procedure:

1. Cut the two blue wires (A) in the location shown.
2. Slide the existing sensor assembly (B) up and off the fuel pump assembly housing.

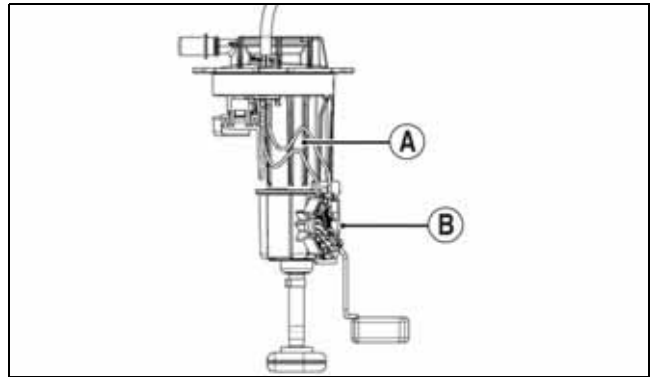

XR257A

3. Keeping the float attached to the float arm, remove the float arm from the existing fuel level sensor. Press the float arm into the new fuel level sensor assembly. Ensure it locks into place.

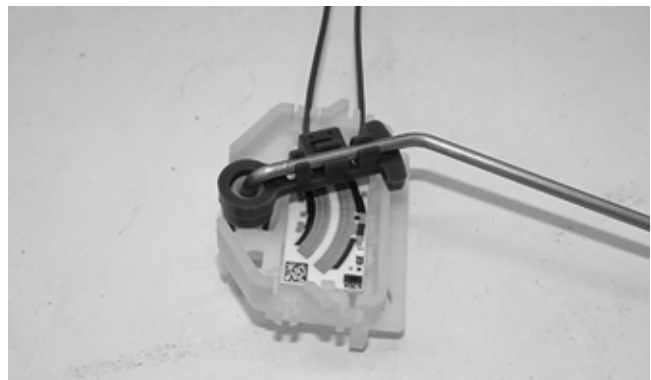

XM366

■NOTE: Inspect the float for any damage or leaking by submerging in water and looking for any air bubbles. Replace if damaged.

4. Install the fuel level sensor assembly onto the fuel pump assembly housing. Once inserted, press down to make sure it locks into place.



MOD482

5. Connect the blue wires using the supplied splice connectors from the fuel level sensor kit. Secure the wires.

Installing Fuel Pump Assembly

1. Place the fuel pump assembly into the fuel tank with a new gasket aligning the match marks; then secure with the fuel tank nut. Tighten to 70 ft-lb (95.2 N-m).

■NOTE: It is important to install the fuel pump with the correct orientation to ensure adequate float lever clearance.

2. Connect the fuel hose and connect the return fuel hose; then connect the electrical plug to the main harness.
3. Connect the negative battery cable; then turn the ignition switch to the ON position and verify that no fuel leaks are present, the pump runs for several seconds, and the fuel gauge reading is normal.
4. Start the engine to verify proper engine operation; then shut off the engine and verify there are no leaks.

TILT SENSOR

⚠ WARNING

Incorrect installation of the tilt sensor could cause sudden loss of engine power which could result in loss of vehicle control resulting in injury or death.

CAUTION

Do not drop the tilt sensor as shock can damage the internal mechanism.

Supply Voltage

1. Disconnect the three-wire connector from the sensor; then select DC Voltage on the multimeter and connect the red tester lead to the orange wire (C) and the black tester lead to the pink/black wire (A).



MOD490

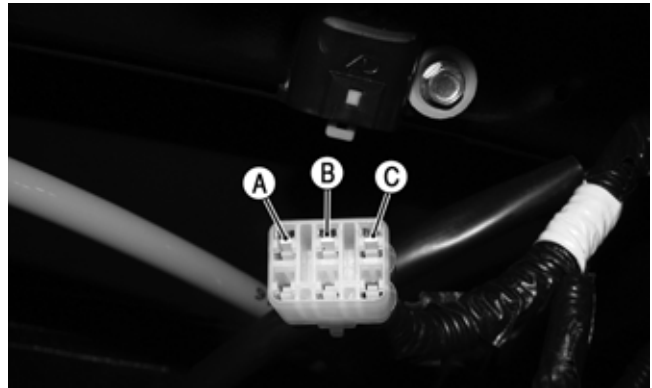

MOD491

2. Turn the ignition switch to the ON position. The multimeter should read battery voltage. If battery voltage is not indicated, check the 20-amp EFI relay or the 10-amp EFI fuse in the PDM, wiring harness, or the ignition switch.
3. Remove the red tester lead and connect to the blue/brown wire. The multimeter should read less than 0.2 DC volts. If the specified voltage is not indicated, check wire connections at the ECM or substitute another ECM to verify the test.

Output Voltage

■NOTE: Needle adapters will be required on the multimeter leads as the following tests are made with the sensor connected.

1. Connect the three-wire plug to the sensor; then remove the right-side mounting screw securing the sensor.



MOD492

2. Install the needle adapters to the multimeter leads; then select DC Voltage on the multimeter.

3. Connect the red tester lead to the blue/brown wire (B) and the black tester lead to the pink/black wire (A); then turn the ignition switch ON and observe the meter. The meter should read 0.4-1.4 DC volts.

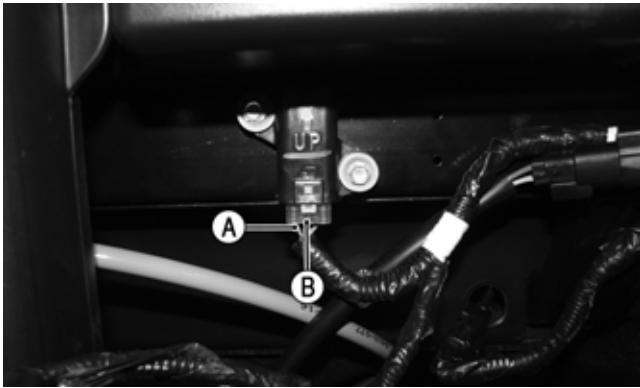

MOD490A

4. Tilt the sensor 60° or more to the left and right observing the meter. The meter should read 3.7-4.4 DC volts after approximately one second in the tilted position. If the meter readings are not as specified, the tilt sensor is defective.

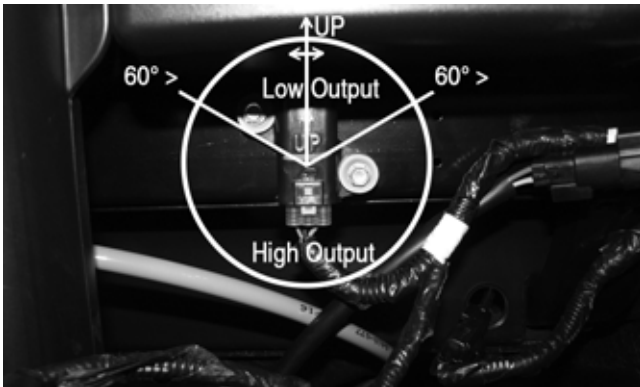

MOD490B

■NOTE: When replacing the sensor after testing, make sure the arrow marking is directed up.

Winch

■NOTE: The winch is only serviceable as an assembly.

REMOVING

1. Disconnect the battery; then remove the front bumper.
2. Remove the four cap screws securing the winch to the winch bracket; then remove the two electrical cables attached to the winch.

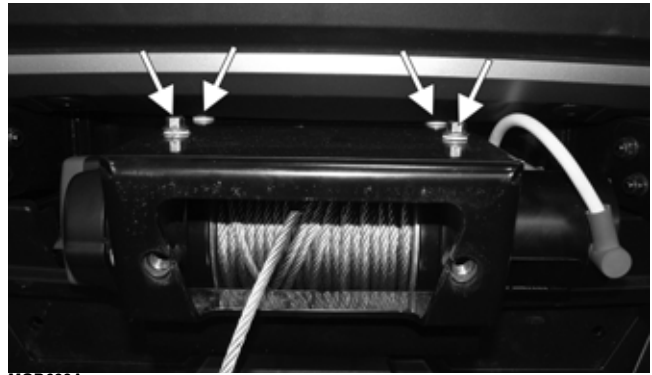

MOD693A

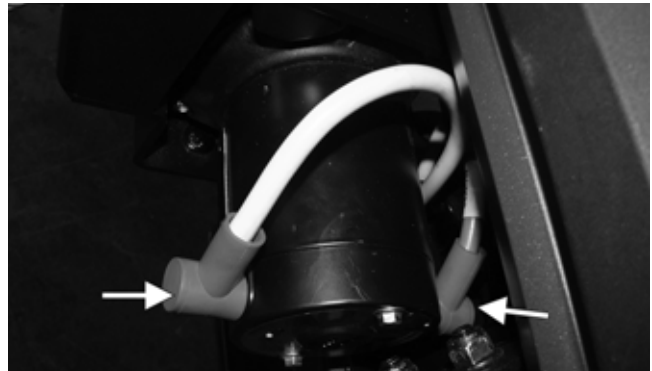

MOD695A

3. Remove the passenger-side bumper bracket; then gently slide the winch out the passenger side of the vehicle.

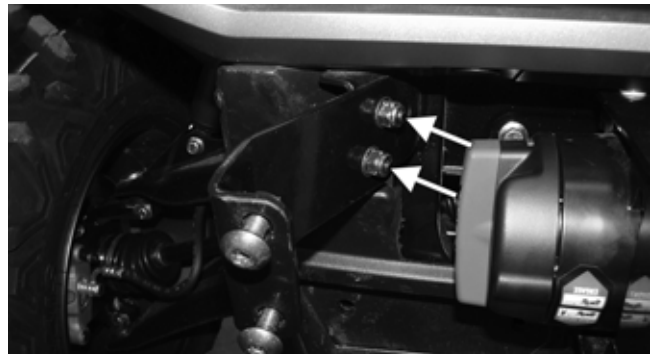

MOD694

INSTALLING

1. Position the winch into place by gently sliding the winch from the passenger side.
2. Install the two power cables to the winch; then install the four cap screws securing the winch to the winch bracket.
3. Install the passenger-side bumper bracket. Do not tighten at this time; then install the bumper; then tighten all fasteners; then reconnect battery.

Starter Motor

■NOTE: The starter motor is only serviceable as an assembly.

REMOVING

1. Disconnect the battery; then remove the clutch cover, drive clutch, driven clutch, drive belt, and inner clutch cover, and flywheel cover.

CAUTION

Always disconnect the negative battery cable from the battery first; then disconnect the positive cable.

2. Remove the nut securing the positive cable to the starter; then remove the cable from the starter (A); then remove the start relay wire (B).



MOD569

3. Remove the two cap screws securing the starter; then remove the starter. Account for the dowel pins.

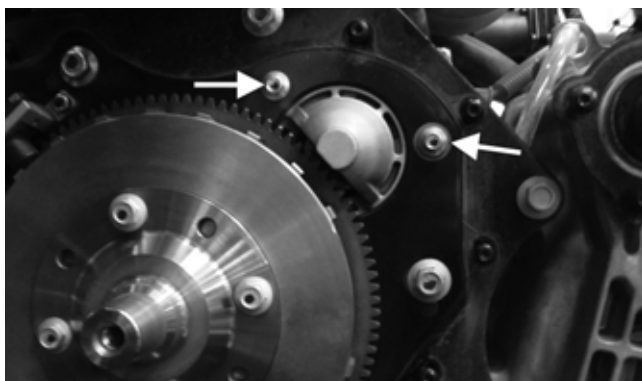

MOD571

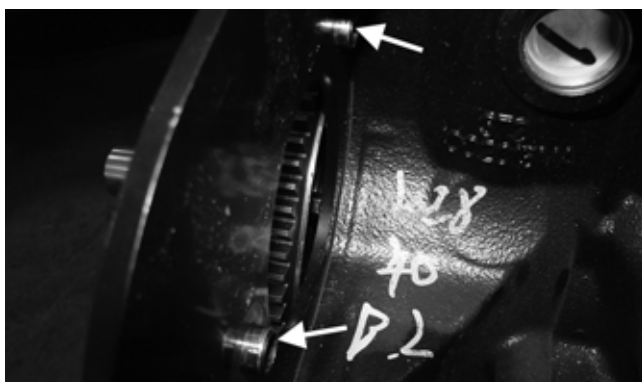

MOD570

INSTALLING

1. Position the dowel pins onto the starter; then install the starter. Secure with two cap screws. Tighten to 14.8 ft-lb (20 N-m).

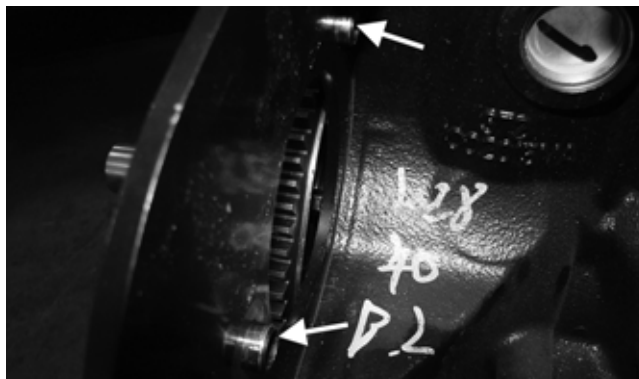

MOD570

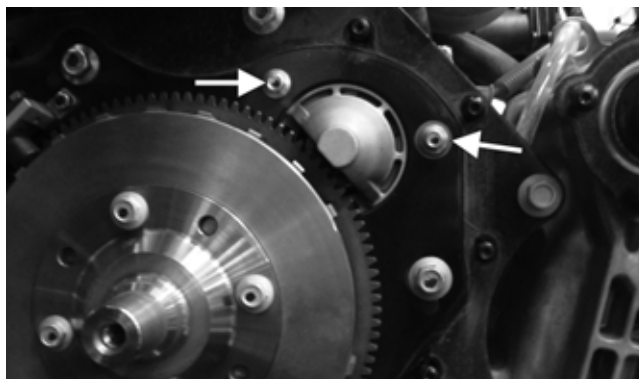

MOD571

2. Secure the positive cable to the starter with the nut; then secure the start relay wire to the terminal.



MOD569

3. Install the flywheel cover, inner clutch cover, drive clutch, driven clutch, drive belt and clutch cover; then connect the battery.

TESTING VOLTAGE

Perform this test on the starter positive terminal.

■NOTE: The ignition switch must be in the ON position, and the shift lever in the PARK position.

1. Set the meter selector to the DC Voltage position.
2. Connect the red tester lead to the starter terminal (A); then connect the black tester lead to ground.

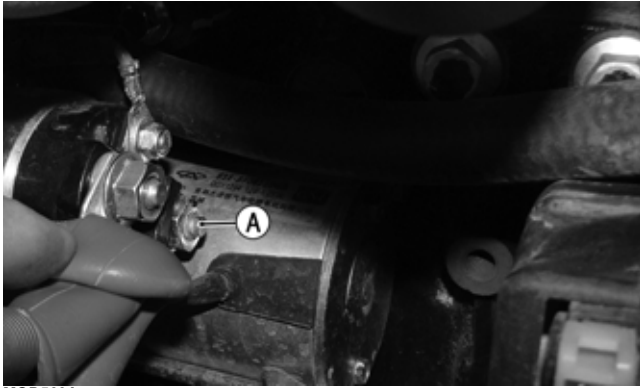

MOD569A

3. With the brake depressed and key switch momentarily held in the start position, the meter must show battery voltage and the starter should operate.

■NOTE: If the meter showed correct voltage but the starter motor did not operate or operated slowly, troubleshoot all starting system components before replacing the starter motor.

■NOTE: If the meter showed no battery voltage, inspect the main fuse, ground connections, starter lead, battery voltage (at the battery), starter relay, or the start relay.

Starter Relay

The starter relay is mounted to the frame behind the passenger seat above the air cleaner assembly.

1. Tilt the cargo box up; then using the multimeter set to the DC Voltage position, check the starter relay that is located above the air filter housing as follows.
2. Connect the red tester lead to the positive battery terminal; then connect the black tester lead to the start relay connection (A) on the starter relay. The meter must show battery voltage.

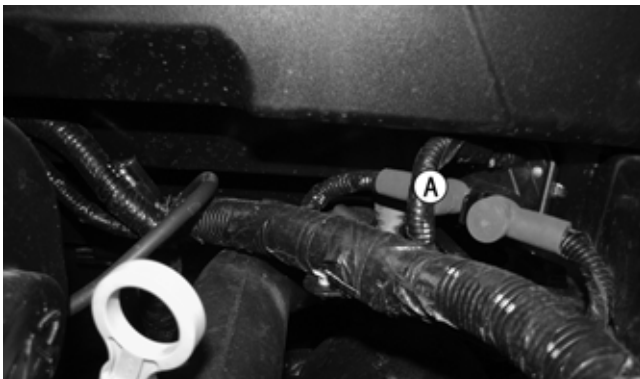

MOD572

■NOTE: Make sure the ignition switch is in the ON position and the shift lever in the PARK position.

3. With the brake depressed, rotate the ignition switch to the START position while observing the multimeter. The multimeter should drop to 0 volts and a “click” should be heard from the relay.

■NOTE: If a “click” is heard and more than 1 volt is indicated by the multimeter, replace the starter relay. If no “click” is heard and the multimeter continues to indicate battery voltage, proceed to step 4.

4. Disconnect the two-wire plug from the starter relay; then connect the red tester lead to the green wire and the black tester lead to the orange wire.



MOD572A

5. With the brake depressed and the ignition switch momentarily held in the START position, observe the multimeter.

■NOTE: If constant battery voltage is indicated, replace the starter relay.

Start Relay

■NOTE: The start relay is not serviced individually. A new starter assembly will be required.

The start relay is attached to the starter.

1. Tilt the cargo box up; then using the multimeter set to the DC Voltage position, check the start relay that is located on the starter as follows.
2. Connect the red tester lead to the positive cable to the start relay (A) and connect the black tester lead to the cable for the starter (B). The meter must show battery voltage.

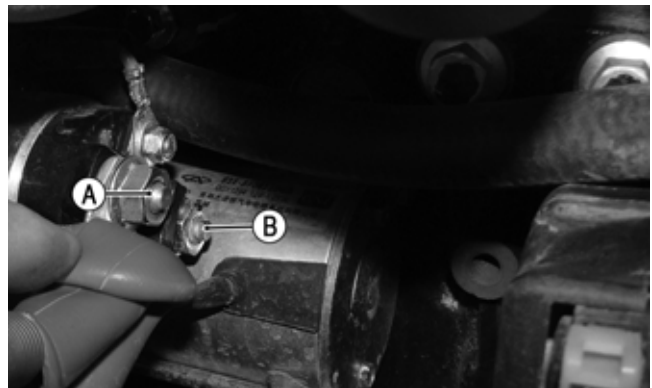

MOD569B

3. With the brake depressed, rotate the key switch to the starter position while observing the multimeter. The multimeter should drop to 0 volts, the starter should engage, and a “click” should be heard from the relay.

■NOTE: If a “click” is heard and more than 1 volt is indicated by the multimeter, replace the start relay. If no “click” is heard and the multimeter continues to indicate battery voltage, proceed to step 4.

4. Disconnect the start relay wire from the terminal on the start relay; then connect the red tester lead to the pink start relay wire (C) and the black tester lead to the battery wire on the starter relay (D).



MOD569D

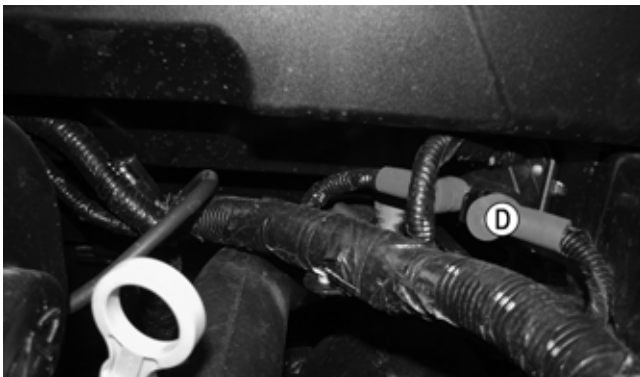

MOD572C

5. With the key switch momentarily held in the start position, observe the multimeter.

■NOTE: If battery voltage is indicated, replace the starter relay.

Alternator/Regulator

TESTING

Prior to performing the following tests, make sure the alternator belt is properly tightened and the battery is fully charged.

1. Using a suitable multimeter, select the DC Voltage position; then connect the red tester lead to the positive battery post and the black tester lead to the negative battery post.
2. Start the engine and slowly increase RPM. The voltage should increase with the engine RPM to a maximum of 15.5 DC volts.

■NOTE: If voltage rises above 15.5 DC volts, the regulator is faulty or a battery connection is loose or corroded. Clean and tighten battery connections or replace the alternator. If voltage does not rise, check all battery connections, the battery wire on the alternator, and the voltage regulator wire. If all are normal, replace the alternator.

■NOTE: The alternator/regulator are only serviceable as assemblies.

REMOVING

1. Remove the passenger rear inner fender; then remove the negative battery cable from the battery.
2. Disconnect the battery wire from the alternator; then disconnect the voltage regulator connector

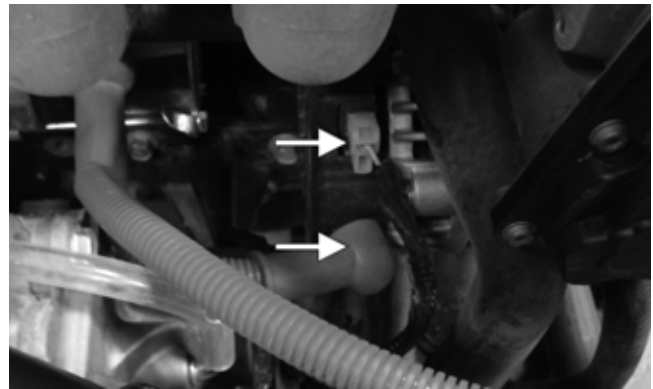

MOD573

3. Loosen the alternator adjuster cap screw (A) and the pivot bolt (B); then remove the serpentine belt.

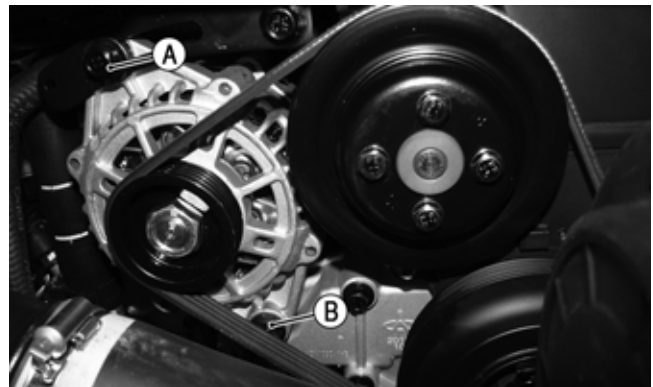

MOD439

4. Remove the adjuster cap screw and pivot bolt and remove the alternator.

■NOTE: The alternator/regulator is only serviceable as an assembly.

INSTALLING

1. Place the alternator/regulator into position on the engine; then secure with the existing hardware. Do not tighten at this time.
2. Place the serpentine belt into position; then using a suitable pry, tension the drive belt so that with a good drive belt it does not spin on the pulley or make noise.

3. Holding tension on the belt, tighten the adjuster cap screw (A) securely; then remove the pry and tighten the pivot bolt (B) securely.

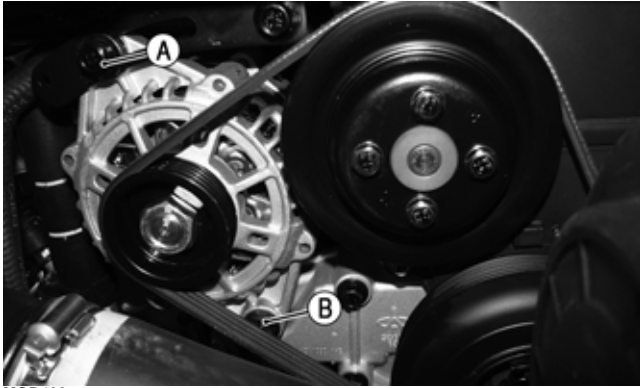

MOD439

4. Connect the battery wire and connect the voltage regulator connector; then connect the negative battery cable to the battery.
5. Install the passenger rear inner fender.

Electronic Control Module (ECM)

The ECM is located beneath the passenger seat near the battery.

■**NOTE:** The ECM is not a serviceable component. If the unit is defective, it must be replaced.

The ECM is rarely the cause for electrical problems; however, if the ECM is suspected, substitute another ECM to verify the suspected one is defective.

This system has a built-in feature that will only allow an ECM of the same part number to be used in this model. Do not attempt to substitute an ECM from a different model as the system will not allow it to start.

Error codes can be cleared by following the procedures located in the Gauge Diagnostic Menu sub-section in this section.

Gauge Diagnostic Menu

DIGITAL GAUGE

The digital gauge has a diagnostic menu that can be used to diagnose many of the DTCs displayed. To place the gauge in the diagnostic mode, use the following procedure.

■**NOTE:** The digital gauge has three buttons: Left (A), Center (B), and Right (C).



MOD234

1. Turn the ignition switch ON.
2. Depress and hold both left and right buttons together for approximately three seconds until "DIAGNOSTIC" appears on the LCD.



MOD233

3. Press the center button (SELECT) to enter diagnostic mode; cycle the display by pressing either the left or right button to step to the desired function.

■**NOTE:** The gauge can be utilized dynamically (engine running/vehicle moving) or statically (engine/vehicle stopped).

DIAGNOSTIC MODES

Battery (BATTERY)



MOD235

Display: System DC voltage.

DTC: P0562, P0563

Usage: Verify system voltage under following conditions:

1. Battery voltage with engine and accessories off (>12.2 VDC for fully charged).

- Battery voltage with engine idling (charging = 13.8 VDC or greater).
- Battery voltage with electrical accessories operating, engine idling (13.5 VDC or greater).
- Battery voltage starter cranking (10.5-11.5 VDC).

Coolant (COOLANT)

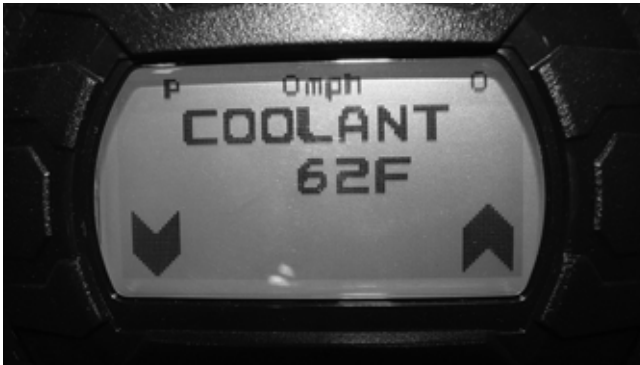

MOD236

Display: Engine coolant temperature as measured by the ECT sensor.

DTC: P0116, P0117, P0118, P0217, P0480, P0691, P0692

Usage: Monitor coolant temperature to verify the following:

- ECT sensor signal.
- High Temperature indicator on @ 230° F (110° C), off @ 203° F (95° C).
- Thermostat starts opening @ approximately 181-189° F (83-87° C), and should be fully open @ approximately 212° F (100° C) indicated by a momentary drop or pause in the rising temperature reading.
- Fan on @ 213° F (100.5° C), off @ 203° F (95° C).

Intake Air Temperature (INTAKE)



MOD575

Display: Intake air temperature as measured by the Temperature Manifold Absolute Pressure (TMAP) sensor.

DTC: P0112, P0113, P0114

Usage: Monitor intake air temperature to verify the following:

- Intake air temperature sensor signal.

Air Pressure (AIR PRESS)



MOD576

Display: Air pressure as measured by the Temperature Manifold Absolute Pressure (TMAP) sensor

DTC: P0068, P0107, P0108

Usage: Monitor air pressure to verify the following:

- Intake air pressure sensor signal.

Throttle Position Sensor (TPS)



MOD577

Display: Throttle position sensor percentage as measured by the throttle position sensor from the throttle body.

DTC: P0068, P0122, P0123, P0222, P0223, P1120, P1121, P1122, P1123, P1124, P1125, P1126, P2135

Usage: Monitor throttle percentage to verify the following while the vehicle is running:

- Throttle position sensor signal from throttle body.
- Movement of throttle body via accelerator position sensor with vehicle running only.

Accelerator Position Sensor (PEDAL)



MOD579

Display: Accelerator position sensor percentage as measured by the accelerator position sensor.

DTC: P2122, P2123, P2127, P2128, P2138

Usage: Monitor accelerator position sensor percentage to verify the following:

1. Accelerator position sensor signal.

Brake Switches (BRAKE)



MOD578

Display: Brake switch signal from switch 1 (front) and switch 2 (rear).

DTC: P0504

Usage: Monitor brake switch signal to verify the following:

1. Brake switch signals.

Engine Control Module (ECM)/ Electronic Power Steering (EPS)



MOD237

Display: Communication from the Engine Control Module (ECM) and the Electronic Power Steering (EPS). "ON" is receiving communication and "OFF" is not receiving communication.

DTC: U0100, U0155

Usage: Monitor connection between the ECM and EPS.

Fuel Sensor (FUEL)



MOD238

Display: Fuel level signal from the fuel level sensor.

DTC: C1400

Usage: Check output of the fuel level sensor:*

1. Full fuel is indicated by a reading of 0-5 ohms.
2. Empty is indicated by a reading of 95-105 ohms.

* If output is 110-500 ohms, suspect the fuel level sensor or wiring. If output is 0-110 ohms but no gauge indication, suspect the gauge.

Tachometer (RPM)



MOD239

Display: Engine RPM

DTC: P0219, P0370, P0371, P0372, P0373, P0374

Usage: Verify engine speed signal from the following:

1. CKP (crankshaft position) sensor to ECM.
2. ECM (CAN) signal to gauge (tachometer).
3. ECM (CAN) signal to EPS.

Speedometer (SPEED)



MOD240

Display: Vehicle speed signal.

DTC: P0500, P0503

Usage: Verify speedometer sensor signal from the following:

1. Speed sensor to ECM.
2. ECM (CAN) signal to gauge (speedometer/odometer).
3. ECM (CAN) signal to EPS.

Diagnostic Trouble Codes (DTC)

If a related chassis component fails or an out-of-tolerance signal is detected by the ECM, a diagnostic trouble code (DTC) will be generated in the ECM and displayed on the LCD. The DTC will be displayed alternately with a wrench icon or malfunction indicator light (MIL). The DTC will continue to flash, until the malfunction is corrected and the code cleared.

Code List

■NOTE: Each of the following numerical codes will have a one-letter prefix of C, P, or U. A “C” prefix denotes a chassis malfunction, a “P” prefix denotes a power train malfunction, and a “U” prefix denotes a loss of communication with the gauge.

■NOTE: Normal malfunction codes are cleared from the LCD when the component is replaced or the malfunction is corrected; however, intermittent codes must be cleared as noted in the code chart.

■NOTE: Low system voltage, loose connections and/or insufficient cranking speed of the engine can cause codes P0370, P0371, P0372, P0373, and P0374.

■NOTE: If there are several random codes being displayed, check the wire harness/connectors.

■NOTE: For Electronic Power Steering (EPS) Diagnostic Trouble Codes (DTC) see the Electronic Power Steering Section.

| Display | Fault Description | Possible Cause | Fault Recovery Method |
|---------|------------------------------------------------------|--------------------------------------------------------------------------------------------------------|-----------------------|
| C0063 | Tilt Sensor Circuit High | Sensor or interconnect harness shorted to battery power. | Correct condition* |
| C0064 | Tilt Sensor Circuit Low/SG/Open | Sensor or interconnect harness open or shorted to chassis ground. | Correct condition* |
| C1263 | Backup/Reverse Circuit Open | The backup/reverse relay has been disconnected or its interconnect harness is open. | Correct condition* |
| C1264 | Backup/Reverse Buzzer Circuit High | The backup/reverse relay or its interconnect harness is shorted to battery power. | Correct condition* |
| C1265 | Backup/Reverse Circuit Low/SG | The backup/reverse relay or its interconnect harness is shorted to chassis ground. | Correct condition* |
| C1400 | Fuel Level Sensor Circuit Open | The fuel level sensor or interconnect harness is open. | Correct condition* |
| P0030 | Oxygen Heater Intermittent/Open | The oxygen heater or its interconnect harness is intermittent or open. | Correct condition* |
| P0031 | Oxygen Heater Low/SG | The oxygen heater or its interconnect harness is shorted to chassis ground. | Correct condition* |
| P0032 | Oxygen Heater High/SP | The oxygen heater or its interconnect harness is shorted to battery power. | Correct condition* |
| P0068 | Throttle Position Sensor MAP Plausibility | Check for a vacuum leak or a plugged air filter. | Correct condition* |
| P0107 | MAP Sensor Circuit Low/SG/Open | The MAP sensor or its interconnect harness is shorted to chassis ground. | Correct condition* |
| P0108 | MAP Sensor Circuit High/SP | The MAP sensor or its interconnect harness is shorted to battery power. | Correct condition* |
| P0112 | Intake Air Temp Sensor Circuit Low/SG | The intake air temperature sensor or its interconnect harness is shorted to chassis ground. | Correct condition* |
| P0113 | Intake Air Temp Sensor Circuit High/Open | The intake air temperature sensor or its interconnect harness is open or shorted to battery power. | Correct condition* |
| P0114 | Intake Air Temp Sensor Circuit Intermittent | The intake air temperature sensor or its interconnect harness is intermittent. | Correct condition* |
| P0116 | Engine Coolant Temp Sensor Circuit Range/Performance | The engine coolant temperature sensor is producing an out-of-range voltage. | Correct condition* |
| P0117 | Engine Coolant Temp Sensor Circuit Low/SG | The engine coolant temperature sensor or its interconnect harness is shorted to chassis ground. | Correct condition* |
| P0118 | Engine Coolant Temp Sensor Circuit High/Open/SP | The engine coolant temperature sensor or its interconnect harness is open or shorted to battery power. | Correct condition* |
| P0122 | Throttle Position Sensor #1 Circuit Low/SG | The throttle position sensor or its interconnect harness is shorted to chassis ground. | Correct condition* |
| P0123 | Throttle Position Sensor #1 Circuit High/Open | The throttle position sensor or its interconnect harness is open or shorted to battery power. | Correct condition* |
| P0130 | Oxygen Sensor Intermittent/Open | The oxygen sensor or its interconnect harness is intermittent or open. | Correct condition* |
| P0131 | Oxygen Sensor Low/SG or Air-Leak | The oxygen sensor or its interconnect harness is shorted to chassis ground or an air leak exists. | Correct condition* |
| P0132 | Oxygen Sensor High/SP | The oxygen sensor or its interconnect harness is shorted to battery power. | Correct condition* |
| P0171 | Oxygen Feedback Below Minimum Correction | Low fuel rail pressure, dirty fuel filter, or dirty injectors. | Correct condition* |
| P0172 | Oxygen Feedback Exceeds Maximum Correction | Excessive fuel rail pressure, MAP or temp sensors out of spec. | Correct condition* |
| P0201 | Cylinder #1 Fuel Injector Circuit Open | Injector #1 has been disconnected or its interconnect harness is open. | Correct condition** |

| Display | Fault Description | Possible Cause | Fault Recovery Method |
|---------|-----------------------------------------------------------------|-----------------------------------------------------------------------------------------------------------------------------------------------------------|-----------------------|
| P0202 | Cylinder #2 Fuel Injector Circuit Open | Injector #2 has been disconnected or its interconnect harness is open. | Correct condition** |
| P0203 | Cylinder #3 Fuel Injector Circuit Open | Injector #3 has been disconnected or its interconnect harness is open. | Correct condition** |
| P0217 | Engine Coolant Over Temperature Detected | There may be a malfunction of the cooling system. | Correct condition* |
| P0219 | Engine Over-Speed Condition | The engine speed (RPM) has exceeded the ECM over-speed setpoint/limit. | Reduce engine speed |
| P0222 | Throttle Position Sensor #2 Circuit Low/SG/Open | The throttle position sensor or its interconnect harness is open or shorted to chassis ground. | Correct condition* |
| P0223 | Throttle Position Sensor #2 Circuit High | The throttle position sensor or its interconnect harness is shorted to battery power. | Correct condition* |
| P0261 | Cylinder #1 Fuel Injector Circuit Low/SG | Injector #1 or its interconnect harness is shorted to chassis ground. | Correct condition** |
| P0262 | Cylinder #1 Fuel Injector Circuit High | Injector #1 or its interconnect harness is shorted to battery power. | Correct condition** |
| P0264 | Cylinder #2 Fuel Injector Circuit Low/SG | Injector #2 or its interconnect harness is shorted to chassis ground. | Correct condition** |
| P0265 | Cylinder #2 Fuel Injector Circuit High | Injector #2 or its interconnect harness is shorted to battery power. | Correct condition** |
| P0267 | Cylinder #3 Fuel Injector Circuit Low/SG | Injector #3 or its interconnect harness is shorted to chassis ground. | Correct condition** |
| P0268 | Cylinder #3 Fuel Injector Circuit High | Injector #3 or its interconnect harness is shorted to battery power. | Correct condition** |
| P0325 | Knock Sensor Range/Performance | The knock sensor or its interconnect harness is shorted to battery power, chassis ground, or open. | Correct condition* |
| P0326 | Knock Sensor Intermittent/Erratic | The knock sensor or its interconnect harness is shorted to battery power, chassis ground, or open. | Correct condition* |
| P0363 | Misfire Detected — Fueling Disabled (cannot be tripped at idle) | There could be a fouled spark plug or poor fuel quality. The ignition coil or fuel injector or their interconnect harnesses could also be malfunctioning. | Correct condition* |
| P0370 | Loss of Crankshaft Position Sensor Synchronization/Gap Position | The crankshaft position sensor is not recognizing teeth as expected. | Correct condition* |
| P0371 | Crankshaft Position Sensor Additional Teeth Detected | The crankshaft position sensor is not recognizing teeth as expected. | Correct condition* |
| P0372 | Crankshaft Position Sensor Missing Tooth | The crankshaft position sensor is not recognizing teeth as expected. | Correct condition* |
| P0373 | Crankshaft Position Sensor Spike Detected | The crankshaft position sensor is not recognizing teeth as expected. | Correct condition* |
| P0374 | Crankshaft Position Sensor Signal Not Detected | The crankshaft position sensor or its interconnect harness is open or shorted to ground. | Correct condition* |
| P0444 | EVAP System Purge Control Valve Circuit Open | The EVAP system purge control valve is disconnected or its interconnect harness is open. | Correct condition* |
| P0458 | EVAP System Purge Control Valve Circuit Low/SG | The EVAP system purge control valve or its interconnect harness is shorted to chassis ground. | Correct condition* |
| P0459 | EVAP System Purge Control Valve Circuit High/SP | The EVAP system purge control valve or its interconnect harness is shorted to battery power. | Correct condition* |
| P0480 | Fan-Primary Relay Control Circuit Open | The primary fan relay or its interconnect harness is open. | Correct condition* |
| P0481 | Fan-Secondary Relay Control Circuit Open | The secondary fan relay or its interconnect harness is open. | Correct condition* |
| P0500 | Vehicle Speed-Sensor | The vehicle speed sensor circuit signal is intermittent or missing. | Correct condition** |
| P0503 | Vehicle Speed Sensor Circuit Intermittent/Erratic/High | The vehicle speed sensor circuit or its interconnect harness is open or shorted to battery power. | Correct condition** |
| P0504 | Brake Switch Priority | Brake pressure switch #1 or its interconnect is open or shorted to chassis ground. | Correct condition* |
| P0562 | System Voltage Low | The battery charge condition is low or the regulator/rectifier output is low. | Correct condition* |
| P0563 | System Voltage High | The battery cable connections are loose or the regulator/rectifier output is high. | Correct condition* |
| P0600 | Serial Communication Link | The ECM detected an internal condition. | Correct condition* |
| P0606 | Internal Monitoring Error | The ECM detected an internal condition. | Correct condition* |
| P060C | Internal Monitoring 3 Error | The ECM detected an internal condition. | Correct condition* |
| P0615 | Starter Relay Circuit | The start switch/button, starter relay, gearswitch or its interconnect harness is erratic or intermittent. | Correct condition* |
| P0616 | Starter Relay Circuit Low | The start switch/button, starter relay or its interconnect harness is intermittent or shorted to chassis ground. | Correct condition* |
| P0617 | Starter Relay Circuit High | The start switch/button, starter relay, or its interconnect harness is intermittent or shorted to battery power. | Correct condition* |
| P061A | Internal Monitoring of Torque Error | The ECM detected an internal condition. | Correct condition* |
| P061F | Electronic Throttle Control Driver Temperature Warning | The ECM detected an internal condition. | Correct condition* |
| P0627 | Fuel Pump Control Circuit Open | The fuel pump control circuit or its interconnect harness is open. | Correct condition* |
| P0628 | Fuel Pump Control Circuit Low/SG | The fuel pump control circuit or its interconnect harness is shorted to chassis ground. | Correct condition* |
| P0629 | Fuel Pump Control Circuit High/SP | The fuel pump control circuit or its interconnect harness is shorted to battery power. | Correct condition* |
| P0630 | VIN Not Programmed or Incompatible | Verify that the LCD gauge and ECM part numbers are correct for the vehicle model number and VIN. | Correct condition* |
| P0641 | Sensor Reference Voltage #1 Circuit Low/Open | 5-volt sensor power circuit #1 has been shorted to chassis ground. | Correct condition* |

| Display | Fault Description | Possible Cause | Fault Recovery Method |
|---------|--------------------------------------------------------------|---------------------------------------------------------------------------------------------------------------------------|-----------------------|
| P0643 | Sensor Reference Voltage #1 Circuit High | 5-volt sensor power circuit #1 has been shorted to battery power. | Correct condition* |
| P0651 | Sensor Reference Voltage #2 Circuit Low/Open | 5-volt sensor power circuit #2 has been shorted to chassis ground. | Correct condition* |
| P0653 | Sensor Reference Voltage #2 Circuit High | 5-volt sensor power circuit #1 has been shorted to battery power. | Correct condition* |
| P0685 | EFI/Main Relay Circuit Open | The Main/EFI relay has been removed or its circuit is open. | Correct condition* |
| P0686 | EFI/Main Relay Circuit Low/SG | The Main/EFI relay or its circuit is shorted to chassis ground. | Correct condition* |
| P0687 | EFI/Main Relay Circuit High/SP | The Main/EFI relay or its circuit is shorted to battery power. | Correct condition* |
| P0691 | Fan-Primary Relay Control Circuit Low/SG | The primary fan relay or its interconnect harness is shorted to chassis ground. | Correct condition* |
| P0692 | Fan-Primary Relay Control Circuit High/SP | The primary fan relay or its interconnect harness is shorted to battery power. | Correct condition* |
| P0693 | Fan-Secondary Relay Control Circuit Low/SG | The secondary fan relay or its interconnect harness are shorted to ground. | Correct condition* |
| P0694 | Fan-Secondary Relay Control Circuit High/SP | The secondary fan relay or its interconnect harness are shorted to battery power. | Correct condition* |
| P1120 | Throttle Position Sensor Lower Position | The electronic throttle valve was unable to cycle through its entire self check range. | Correct condition* |
| P1121 | Throttle Position Sensor Lower Adaption | The electronic throttle valve was unable to cycle through its entire self check range. | Correct condition* |
| P1122 | Throttle Position Sensor Lower Return | The electronic throttle valve was unable to cycle through its entire self check range. | Correct condition* |
| P1123 | Throttle Position Sensor Adaption Condition | The electronic throttle valve was unable to cycle through its entire self check range. | Correct condition* |
| P1124 | Throttle Position Sensor Limp Home Adaption | The electronic throttle valve was unable to cycle through its entire self check range. | Correct condition* |
| P1125 | Throttle Position Sensor Upper Position | The electronic throttle valve was unable to cycle through its entire self check range. | Correct condition* |
| P1126 | Throttle Position Sensor Upper Return | The electronic throttle valve was unable to cycle through its entire self check range. | Correct condition* |
| P2100 | Throttle Actuator Control Motor Circuit Open | The electronic throttle control actuator or its interconnect harness is open. | Correct condition* |
| P2102 | Throttle Actuator #1 Control Motor Circuit Low/SG | The electronic throttle control actuator or its interconnect harness is shorted to chassis ground. | Correct condition* |
| P2103 | Throttle Actuator #1 Control Motor Circuit High/SP | The electronic throttle control actuator or its interconnect harness is shorted to battery power. | Correct condition* |
| P2106 | Electronic Throttle Control Output Is Out Of Range | The ECM detected an internal condition. | Correct condition* |
| P2107 | Electronic Throttle Control Driver Over-Temperature | The ECM detected an internal condition. | Correct condition* |
| P210C | Throttle Actuator #2 Control Motor Circuit Low/SG | The electronic throttle control actuator or its interconnect harness is shorted to chassis ground. | Correct condition* |
| P210D | Throttle Actuator #2 Control Motor Circuit High/SP | The electronic throttle control actuator or its interconnect harness is shorted to battery power. | Correct condition* |
| P2118 | Throttle Actuator Control Motor Range Error | The electronic throttle control actuator wires or its interconnect harness are shorted together. | Correct condition* |
| P2119 | Throttle Control Actuator Control Performance Error | Either the positive or the negative wire of the electronic throttle control actuator or its interconnect harness is open. | Correct condition* |
| P2122 | Pedal Position Sensor #1 Circuit Low/Open/SG | The pedal position sensor or its interconnect harness is shorted to chassis ground or open. | Correct condition* |
| P2123 | Pedal Position Sensor #1 Circuit High/SP | The pedal position sensor or its interconnect harness is shorted to battery power. | Correct condition* |
| P2127 | Pedal Position Sensor #2 Circuit Low/Open/SG | The pedal position sensor or its interconnect harness is shorted to chassis ground or open. | Correct condition* |
| P2128 | Pedal Position Sensor #2 Circuit High/SP | The pedal position sensor or its interconnect harness is shorted to battery power. | Correct condition* |
| P2135 | Throttle Position Sensor Plausibility Error | One of the throttle position sensor circuits is shorted to either battery power, ground, is open, or a faulty sensor. | Correct condition* |
| P2138 | Pedal Position Sensor Plausibility Error | One of the throttle position sensor circuits is shorted to either battery power, ground, is open, or a faulty sensor. | Correct condition* |
| P2299 | Brake Pedal Position/Accelerator Pedal Position Incompatible | The brake light pressure switch is active while the accelerator pedal is being depressed. | Correct condition* |
| P2300 | Ignition Coil #1 Primary Circuit Low/SG/Open | Ignition coil #1 primary circuit or its interconnect harness is open or shorted to chassis ground. | Correct condition** |
| P2301 | Ignition Coil #1 Primary Circuit High | Ignition coil #1 primary circuit or its interconnect harness is shorted to battery power. | Correct condition** |
| P2303 | Ignition Coil #2 Primary Circuit Low/Open | Ignition coil #2 primary circuit or its interconnect harness is open or shorted to chassis ground. | Correct condition** |
| P2304 | Ignition Coil #2 Primary Circuit High | Ignition coil #2 primary circuit or its interconnect harness is shorted to battery power. | Correct condition** |
| P2306 | Ignition Coil #3 Primary Circuit Low/Open | Ignition coil #3 primary circuit or its interconnect harness is open or shorted to chassis ground. | Correct condition** |
| P2307 | Ignition Coil #3 Primary Circuit High | Ignition coil #3 primary circuit or its interconnect harness is shorted to battery power. | Correct condition** |
| P2610 | ECU Warm Reset | System voltage may have been temporarily too low to power the ECU. | Correct condition* |

| Display | Fault Description | Possible Cause | Fault Recovery Method |
|----------|-----------------------------------------------------|--------------------------------------------------------------------------------------|-------------------------------------|
| U0100 | Lost Communication with ECM | The ECM CAN circuit or its interconnect harness is intermittent or has failed. | Correct condition* |
| U0155 | LCD Gauge to ECM CAN Communication Lost | The LCD gauge CAN circuit or its interconnect harness is intermittent or has failed. | Correct condition* |
| U1000 | Vehicle Not Registered or Invalid PIN Entered | A valid registration PIN has not yet been entered | Enter the correct registration PIN* |
| U1001 | Vehicle Not Registered, Engine Hours Exceed 5 Hours | A valid registration PIN has not yet been entered | Enter the correct registration PIN* |
| FUEL OFF | Tilt Sensor Activation Code | The chassis tilt sensor has been activated. | Correct condition* |

High: A high voltage condition has been detected.
Low: A low voltage condition has been detected.
Intermittent: An intermittent circuit condition has been detected.
Open: An open circuit condition has been detected.

* After correcting the condition, cycle the key switch On-Off-On.
**After correcting the condition, cycle the key switch On-Off-On, start the engine and drive vehicle, then cycle the key switch On-Off-On.

Wiring Diagram

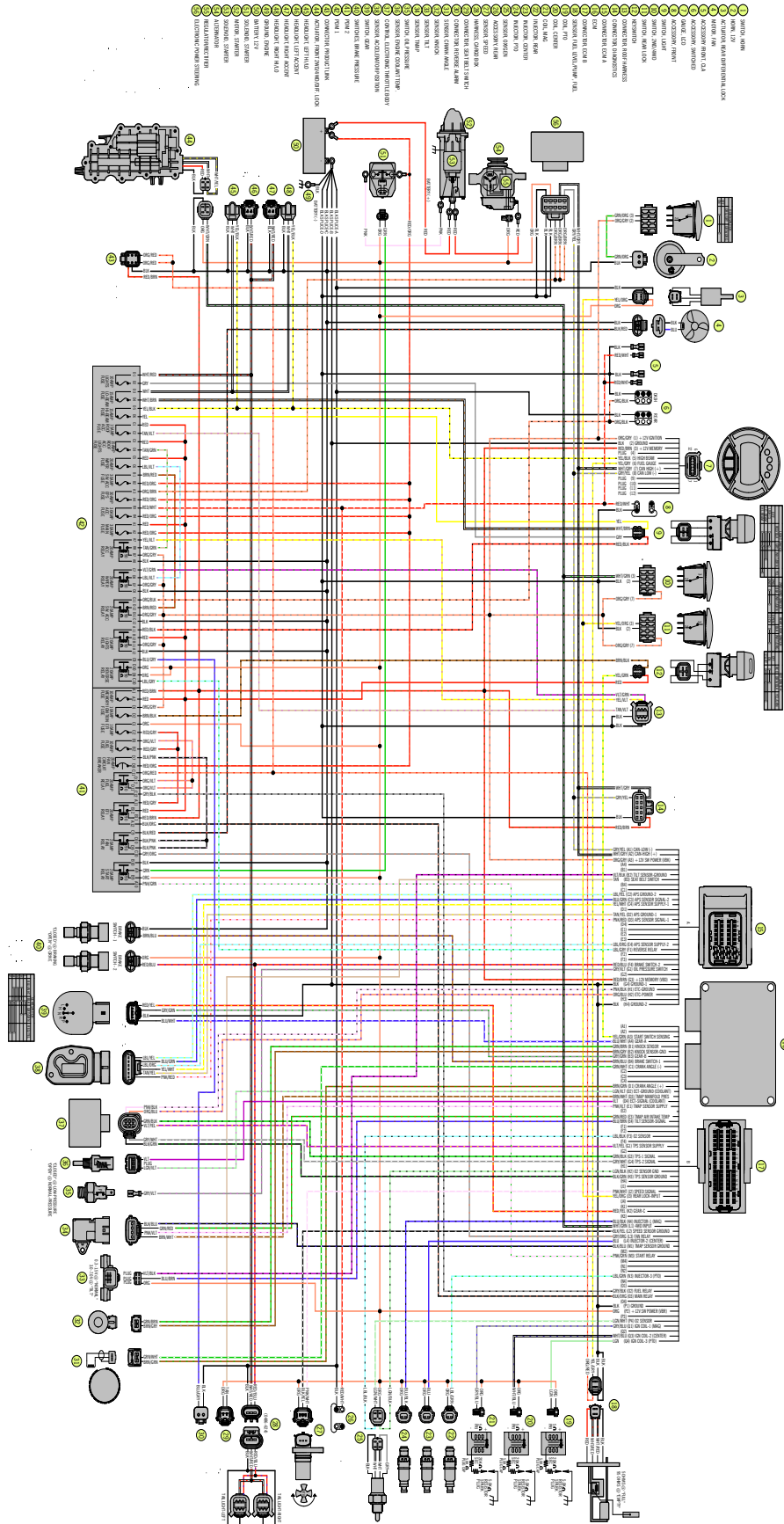

Troubleshooting

| | |
|------------------------------------------------------------------------------------------------------------------------------------------------------------------------------------------------------------------------------------|--------------------------------------------------------------------------------------------------------------------------------------------------------------------------------|
| Problem: Battery does not charge | |
| Condition | Remedy |
| 1. Battery wires/connections shorted — loose — open 2. Serpentine belt loose — bad 3. Alternator/regulator failed | 1. Repair — replace — tighten battery wires/connections 2. Tighten — replace belt 3. Replace alternator assembly |
| Problem: Charging unstable | |
| Condition | Remedy |
| 1. Battery wires/connections shorted — loose — open 2. Serpentine belt loose 3. Alternator/regulator failing | 1. Repair — replace — tighten battery wires/connections 2. Tighten — replace belt 3. Replace alternator assembly |
| Problem: Starter does not engage | |
| Condition | Remedy |
| 1. Battery charge low 2. Switch contacts defective 3. Start relay defective 4. Starter relay defective 5. Wiring connections loose — disconnected 6. Key switch defective | 1. Recharge — replace battery 2. Replace switch 3. Replace start relay 4. Replace starter relay 5. Connect — tighten — repair connections 6. Replace key switch |
| Problem: Battery discharges too rapidly | |
| Condition | Remedy |
| 1. Battery sulfided 2. Electrical system excessively loaded 3. Battery short-circuited 4. Charging system not charging | 1. Replace battery 2. Reduce load 3. Replace battery 4. Replace alternator — tighten serpentine belt |
| Problem: Battery polarity reversed | |
| Condition | Remedy |
| 1. Battery incorrectly connected | 1. Reverse connections — replace battery — repair damage |

Drive System

GENERAL INFORMATION

The front differential is a 3.0:1 ratio.

The die-cast aluminum housings have been assembled with thread-rolling screws (trilobular). When assembling with these screws, start the screws carefully into the housing; then use the following torque values:

| Size | New Housing | Reassembled Housing |
|-----------------------|---------------------|---------------------|
| M6 (Torx T-30 Recess) | 9 ft-lb (12.2 N-m) | 8 ft-lb (10.9 N-m) |
| M8 (Torx T-40 Recess) | 28 ft-lb (38.1 N-m) | 22 ft-lb (29.9 N-m) |

■**NOTE:** Never reuse a lock nut. Once a lock nut has been removed, it must be replaced with a new lock nut.

SPECIAL TOOLS

A number of special tools must be available to the technician when performing service procedures in this section. Refer to the current Special Tools Catalog for the appropriate tool description.

■**NOTE:** When indicated for use, each special tool will be identified by its specific name, as shown in the chart below, and capitalized.

| Description | p/n |
|----------------------------------|-------------|
| Hub Retaining Wrench | 0444-270 |
| Drive Clutch Puller | 0744-080 |
| Drive and Driven Holder | 0444-317 |
| CV Boot Clamp Tool | Common Tool |
| Gear Case Seal Installation Tool | 0443-073 |

■**NOTE:** Special tools are available from the Service Department.

Front Drive Actuator

■**NOTE:** The actuator is only serviceable as an assembly.

■**NOTE:** The actuator will operate only when the ignition switch is in the ON position.

The front drive actuator is located on the left side of the front differential input housing. With the engine stopped and the ignition switch in the ON position, a momentary “whirring” sound can be heard each time the 2WD/4WD drive select switch is shifted. If no sound is heard, see Electrical System section. If the actuator runs constantly or makes squealing or grinding sounds, the actuator must be replaced.

REMOVING

■**NOTE:** The front differential must be removed to remove the front drive actuator.

1. Remove the front differential.
2. Using a Torx wrench, remove the mounting cap screw from the driveshaft side of the actuator.

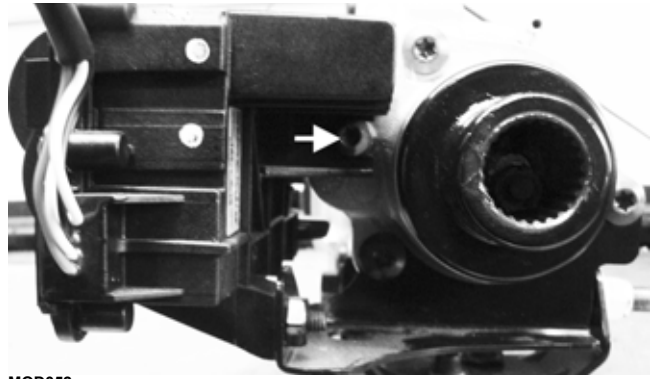

MOD352

3. Remove the mounting cap screw from below the actuator.



MOD353

4. Loosen but do not remove the mounting cap screw at the front of the actuator; then slide the actuator to the rear enough to clear the slotted mounting tab and the selector shaft.

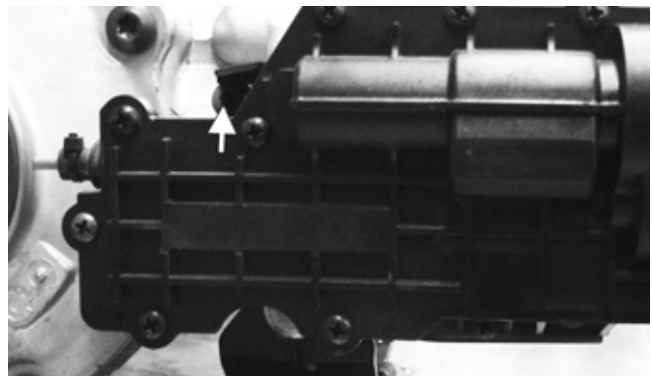

MOD353A

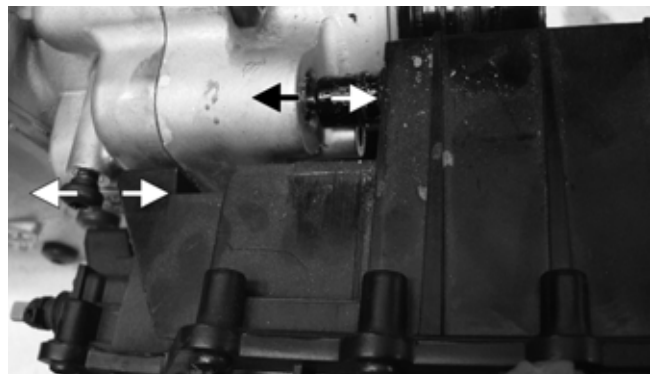

MOD354

INSTALLING

1. Lubricate the O-rings on the actuator; then ensure all mounting surfaces are clean and free of debris.
2. Gently align the actuator with the selector shaft and slide it together onto the shaft taking care to engage the cap screw in the slot of the front mounting tab.

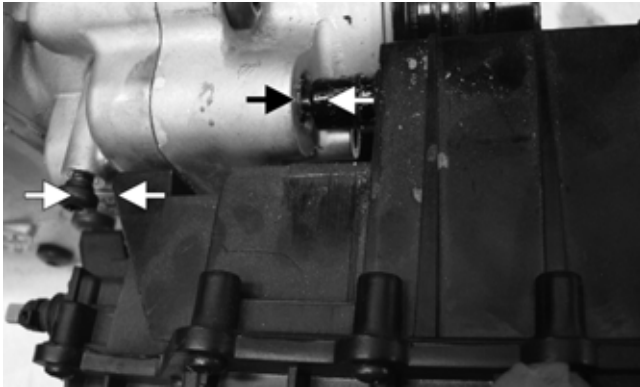

MOD354A

3. While holding the actuator firmly forward, tighten the front cap screw to hold the actuator in place; then install but do not tighten the two remaining cap screws.

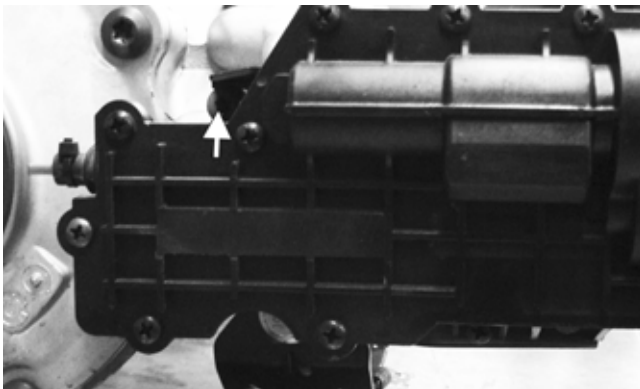

MOD353A

4. Loosen the front cap screw; then tighten the cap screw on the driveshaft side.

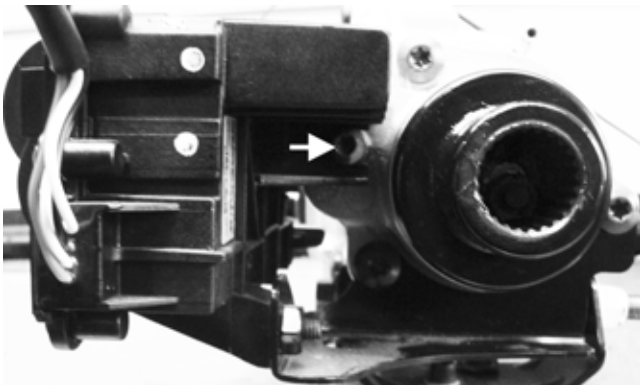

MOD352

■NOTE: It is important to tighten this cap screw while the others are loose to ensure proper seating of the actuator.

5. Tighten the remaining cap screws; then install the front differential; then connect the electrical plug to the main harness; then secure the electrical plug.

6. Turn the ignition switch to the ON position and check the operation by shifting the drive select switch several times.

Front Differential

REMOVING

1. Remove the front hubs (see Hub/Brake Disc in this section).
2. Remove the drain plug and drain the gear lubricant into a drain pan; then install the plug and tighten to 45 in.-lb (5.08 N-m).

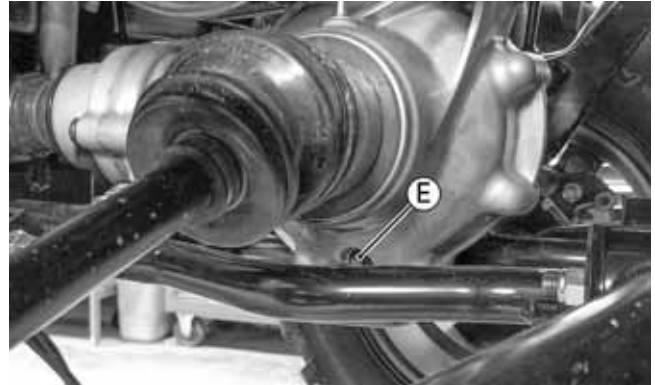

MOD126A

3. Located above the front drive actuator (A). Disconnect the front drive actuator connector from the main harness.



MOD344

4. Remove the outer tie rods from the knuckle; then remove the lower and upper ball joint cap screws taking care not to strip the threads on the ball joint shaft; then, using a rubber mallet, tap the end of the axle and free it from the knuckle assembly. Repeat for the other side. Discard lock nuts. Inspect cap screws and replace if damaged.



MOD325

5. Pull the steering knuckle away from the axle.

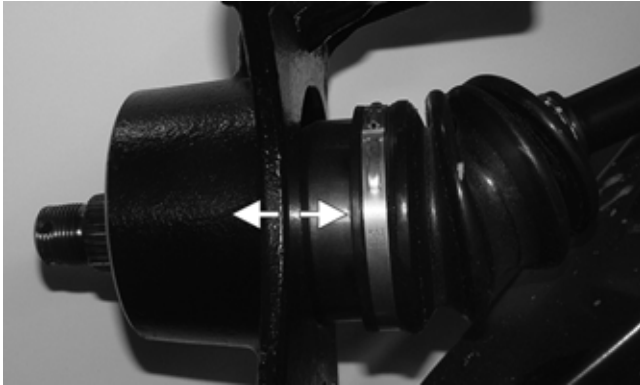

MOD349

6. Support the axle to prevent it from dropping or hanging; then repeat steps 6 and 7 for the other side.

CAUTION

The axle must be supported. If the axle is allowed to drop or hang, damage to the inner CV joint may occur.

7. Remove the lower shock cap screws. Account for the lock nuts; then move the shock and upper A-arm up and secure them with a strap. Repeat for other side. Discard lock nuts. Inspect cap screws and replace if damaged.

■NOTE: The axle shaft must be pushed straight into the inner CV joint straight.

8. Push the axle shaft (A) toward the inner CV joint housing (B) to release the “plunge” coupler; then while the axle shaft and the inner CV joint housing are pushed together, remove the axle from the differential; then account for the O-ring (C). Repeat for the opposite side.



MOD350

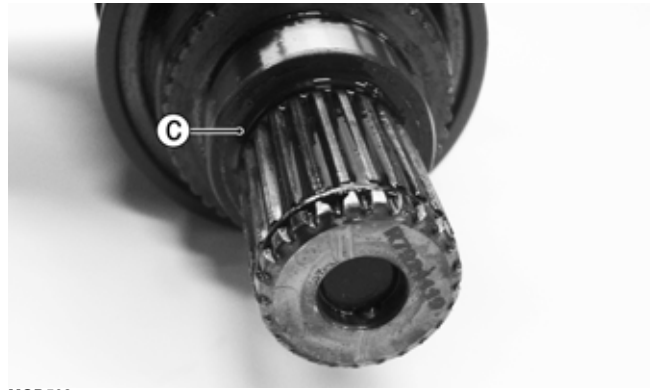

MOD502

9. Remove the upper differential mounting cap screw. Discard lock nut. Inspect cap screw and replace if damaged.

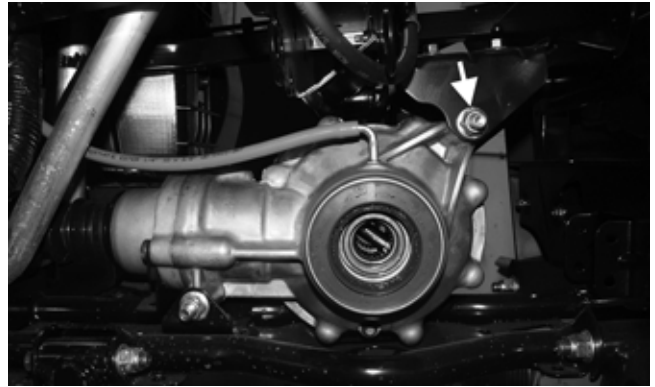

MOD345

10. Remove the upper differential mounting bracket cap screws; then remove the upper differential mounting bracket.

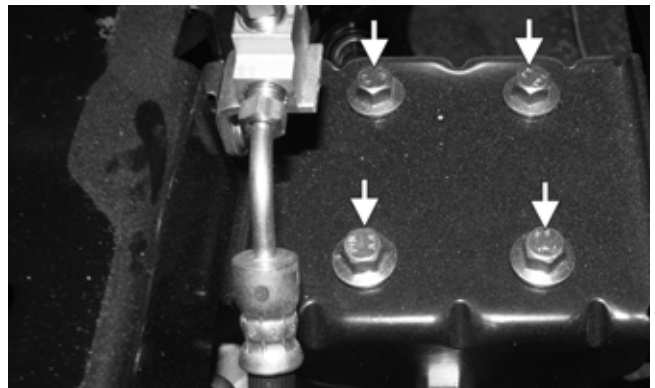

MOD346

11. Remove the lower differential mounting bracket cap screws.

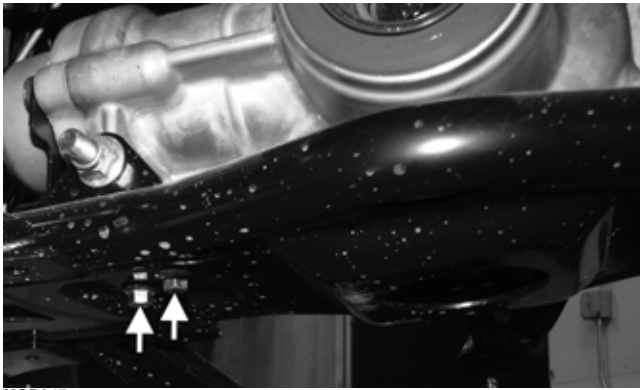

MOD347

12. Gently slide the front differential toward the front of the vehicle; Free the differential assembly from the frame mountings and separate from the front drive-shaft. Account for the rubber boot (A) and O-rings (B) and driveshaft bumper (C); then remove the front differential vent hose.

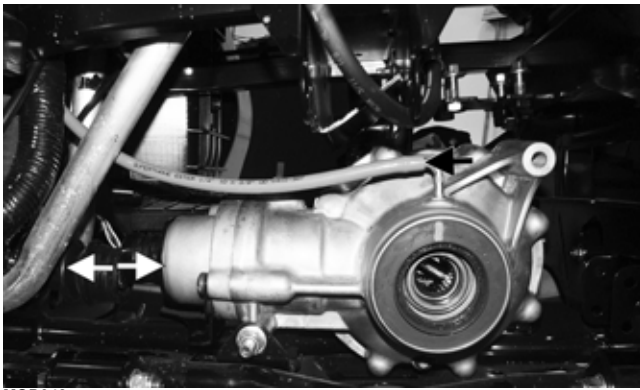

MOD348

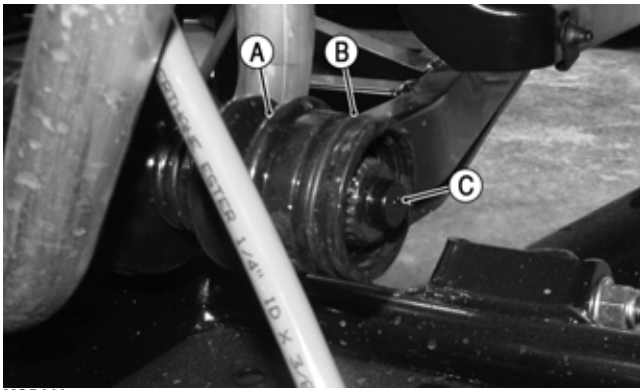

MOD362



MOD363

13. From the passenger side remove the front differential from the vehicle.

Disassembling Input Shaft

1. Remove the front differential; then remove the actuator on the front differential; then using a Torx wrench, remove the cap screws securing the pinion housing and actuator bracket; then remove the actuator bracket (A).

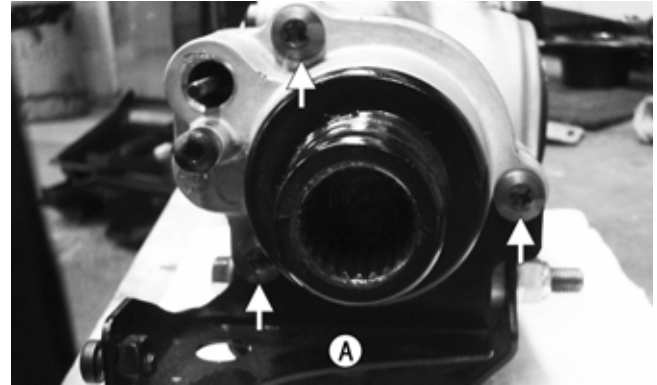

MOD355

2. Using a rubber mallet, remove the housing. Account for a gasket. Remove the fork, collar, and spring. Note the location of all the components for assembling purposes.



MOD356



GC015

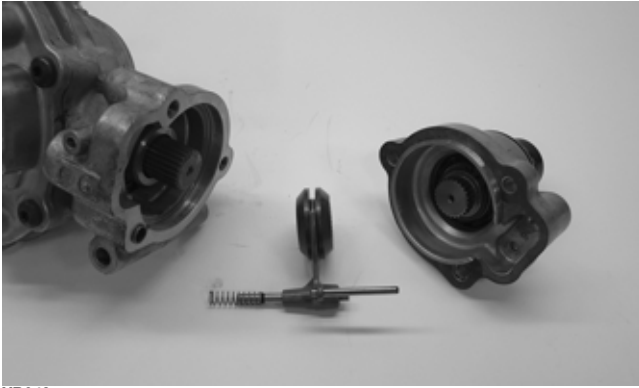

XR348

3. Remove the snap rings from the input shaft; then remove the input shaft from the pinion housing.

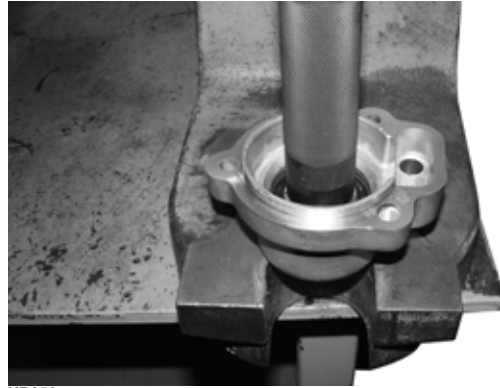

XR350



GC009A

4. Using a seal removal tool, remove the input shaft seal. Account for a spacer.



XR351

Assembling Input Shaft

1. Place the pinion housing in a press and install the input shaft bearing. Secure the bearing with the existing snap ring making sure the sharp edge of the snap ring faces to the outside.



GC010

5. Remove the snap ring securing the input shaft bearing; then place the pinion housing in a press and remove the bearing.



GC012



GC011



GC011

2. Install the input shaft seal making sure it is fully seated in the edge of the housing.

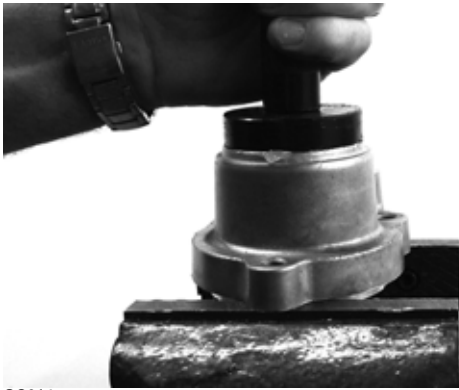

GC014

3. Lubricate the input shaft with High-Performance #2 Molybdenum Disulfide Grease packing the splines; then assemble allowing excess grease to freely escape. Grease the pinion housing seal; then install the input shaft into the pinion housing and secure with a new snap ring.

■NOTE: Any time drive splines are separated, clean all splines with parts-cleaning solvent and dry with compressed air; then lubricate with recommended grease.



GC009A

4. With the return spring over the shuttle shaft, place the shuttle shaft with O-ring into the differential housing.

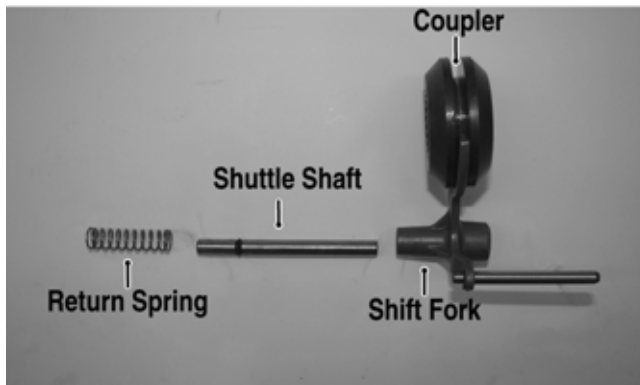

XR352A

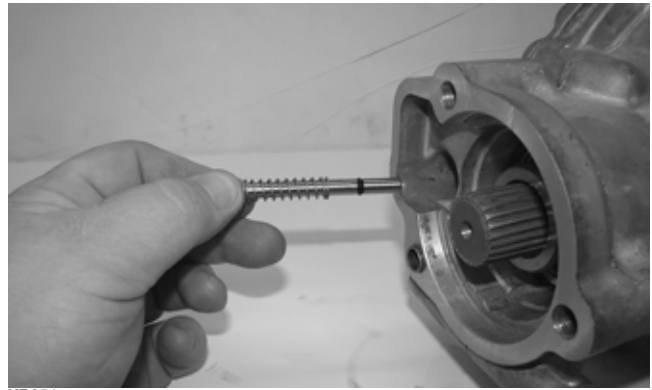

XR354

5. Place the dowel pin into the differential housing; then install a new gasket. Place the coupler onto the shift fork; then simultaneously engage the shift fork to the shuttle shaft and the internal splines of the coupler to the splines of the pinion gear shaft; then verify the shift fork moves freely from 4WD to 2WD to 4WD by pushing down on the shift fork shaft and then releasing.

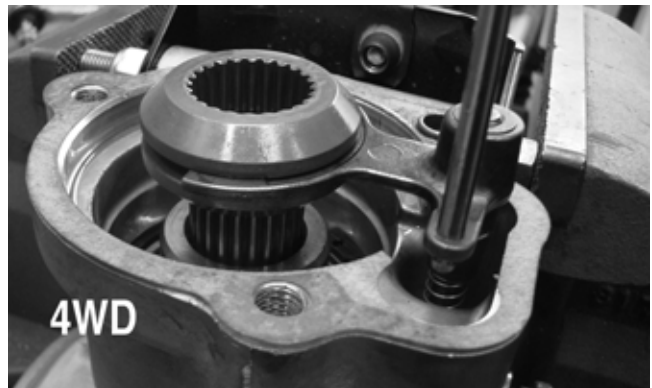

MOD357

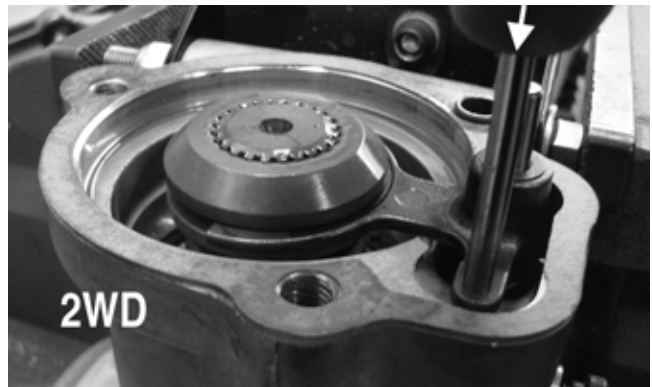

MOD358

6. Align the splines of the output shaft to the internal splines of the coupler; then place the pinion housing onto the differential housing; then place the drive actuator bracket (A) into position; then secure the assembly with three cap screws and tighten to 22 ft-lb (29.9 N-m) (existing) or 28 ft-lb (38.1 N-m) (new differential housing).

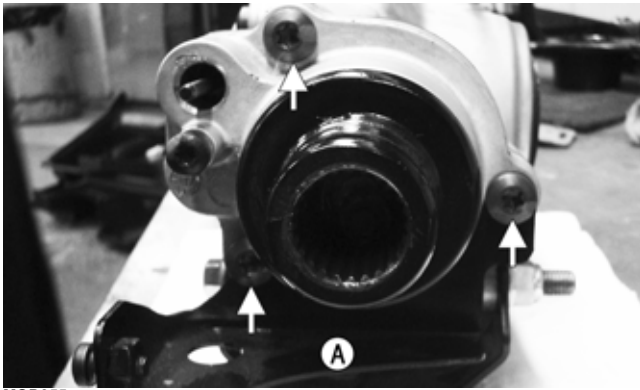

MOD355

Disassembling Differential Assembly

1. Using a Torx wrench, remove the cap screws securing the pinion housing; then remove pinion housing. Account for the coupler, fork, shuttle shaft with O-ring, and spring.

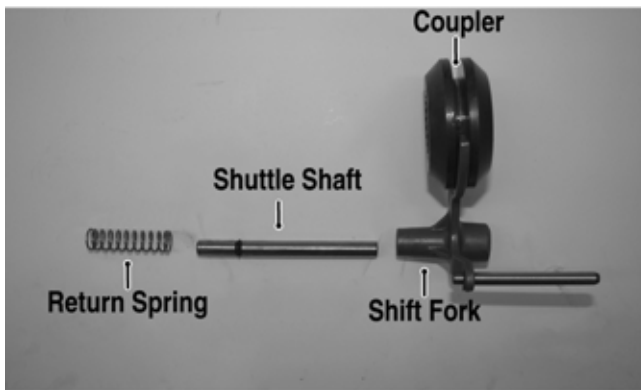

XR352A

2. Using a Torx wrench, remove the cap screws securing the differential cover.

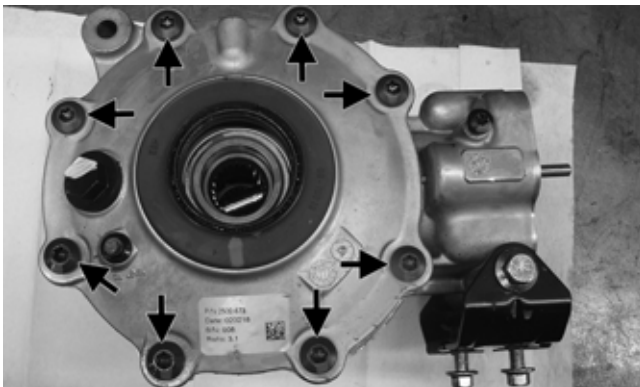

MOD359

3. Using a plastic mallet, tap lightly to remove the differential cover. Account for an O-ring (A) and note the location of any shims.



MOD360

■NOTE: If the cover is difficult to remove, pry on the cover in more than one recessed location.

4. Gently remove the spider assembly and note the location of any shims.

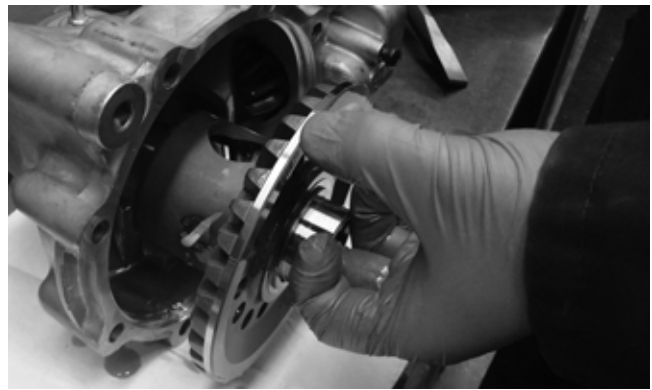

MOD361

Disassembling Pinion Gear

1. Remove the internal snap ring securing the pinion bearing in the housing.

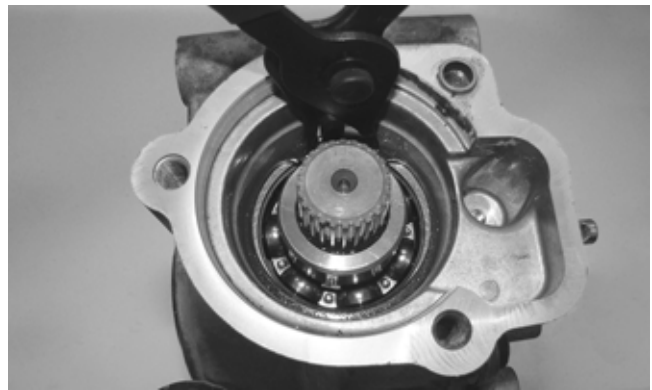

WC430

2. Using a suitable tool and a hammer, remove the pinion gear from the gear case housing.



XR359

3. Secure the pinion gear in a bearing puller; then remove the pinion bearing using a press. Account for a collar and a bearing.

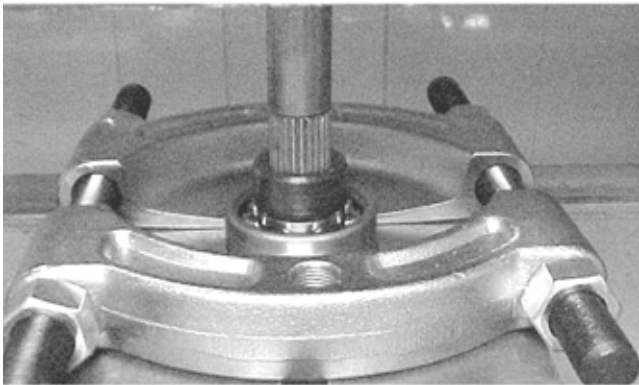

CC879

4. Remove any reusable parts from the gear case housing; then discard the housing and lock collar.

Assembling Pinion Gear

1. Install the bearing onto the pinion shaft. Install the pinion shaft collar.

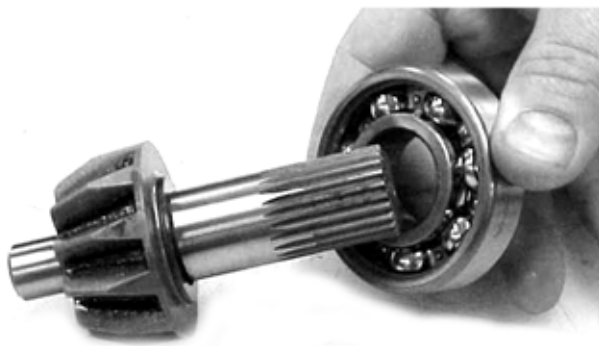

CC882

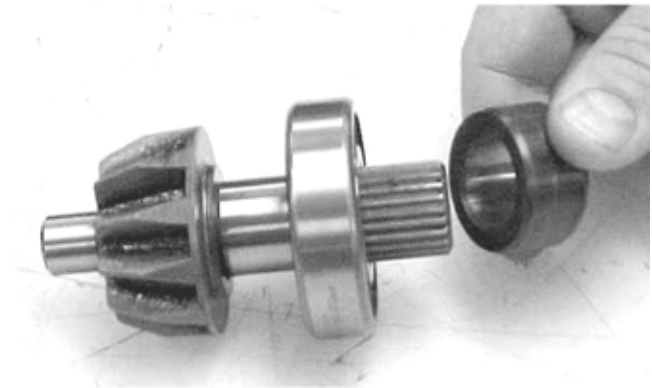

CC883

2. Place the pinion assembly in a bearing puller; then install the bearing using a press.

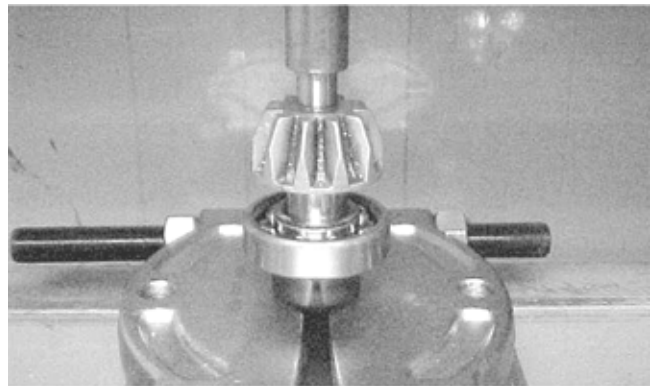

CC884

3. Using a propane torch, heat the gear case housing to approximately 200° F; then install the pinion assembly.
4. Install the internal snap ring with the sharp side directed away from the bearing.



WC429

Shimming Procedure/Shim Selection

It is very important to adjust bevel gears for the proper running tolerances. Gear life and gear noise are greatly affected by these tolerances; therefore, it is very important to properly adjust any gear set prior to final assembly.

The following procedure can be used on both front differential or rear drive gear case.

■NOTE: All bearings must be installed in the gear case and the pinion properly installed before proceeding.

Backlash

■NOTE: Always set backlash prior to any other shimming.

1. Install the existing shim or a 0.051-0.055-in. shim on the gear case side of the ring gear assembly.



GC031A

2. Install the ring gear with shim in the gear case; then while holding the pinion stationary, rock the ring gear forward and back to determine if any backlash exists. If no backlash exists, install a thicker shim and recheck.



GC036A

3. Install the existing shim or a 0.063 in. shim on the cover side of the ring gear; then place the assembled gear case cover onto the gear case and secure with three cap screws. Tighten evenly using a crisscross pattern.



GC036B

5. Place the appropriate tool into the splines of the ring gear and install a dial indicator making sure it contacts the gauge at a 90° angle and on the index mark.



GC040



GC039A

6. Zero the dial indicator; then while holding the pinion stationary, rock the ring gear assembly forward and back and record the backlash. Backlash must be 0.011-0.015 in. If backlash is within specifications, proceed to Ring Gear End-Play. If backlash is not within specifications, increase shim thickness to increase backlash or decrease shim thickness to decrease backlash.

■NOTE: Higher backlash settings usually result in quieter gear operation.

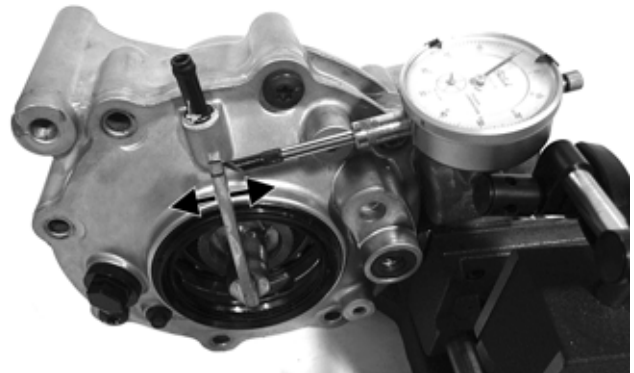

GC037A

Ring Gear End-Play

After correcting backlash, ring gear end-play can be adjusted. To adjust end-play, use the following procedure.

1. Secure the gear case in a holding fixture with the cover side up; then install a dial indicator contacting the ring gear axle flange.



GC035

2. Zero the dial indicator; then push the ring gear toward the dial indicator and release. End-play should be 0.004-0.008 in.
3. To increase end-play, decrease the shim thickness. To decrease end-play, increase the shim thickness.

■NOTE: Once proper backlash and end play are established, the gear case can be assembled.

Assembling Differential Assembly

1. With the pinion gear and new bearings installed, place the selected (backlash) shim on the gear case side of the ring gear with the chamfered side toward the ring gear; then install into gear case/differential housing.



GC031A



GC020

2. Place the selected (end-play) shim, chamfered side toward the gear, onto the cover side of the ring gear.



GC036B

■NOTE: The spider and ring gear assembly must be replaced as a complete unit.

3. Apply a liberal coat of grease to the O-ring; then install it on the assembled cover assembly making sure to seat the O-ring completely down around the circumference of the inner cover.

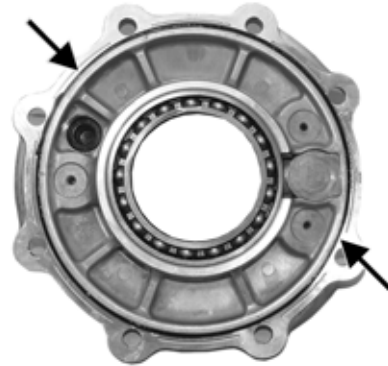

GC075B

4. Making sure the O-ring is properly positioned on the differential housing cover assembly, install the cover with existing cap screws (coated with green Loctite #270). Tighten the cap screws evenly to 22 ft-lb (29.9 N-m).

■NOTE: Grease can be applied to the O-ring for ease of assembling.

■NOTE: If a new housing is being installed, tighten the cap screws to 28 ft-lb (38.1 N-m).

5. Install the shift fork shaft w/spring into the housing making sure the shaft O-ring is positioned to the inside.



XR354

6. Install the shift fork assembly making sure the fork leg is facing upward. Apply a small amount of oil to the gasket; then install the gasket.

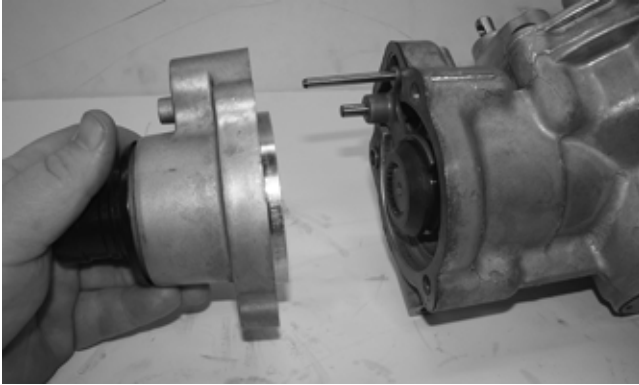

XR353

7. Place the input shaft assembly onto the gear case housing; then with the actuator bracket in place, secure with the existing cap screws. Tighten to 22 ft-lb (29.9 N-m).

■NOTE: If a new housing is being installed, tighten the cap screws to 28 ft-lb (38.1 N-m).

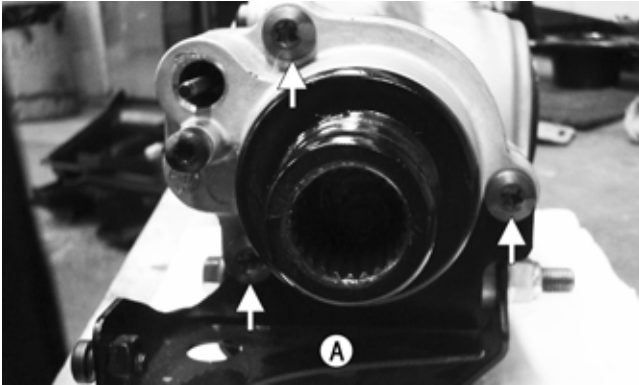

MOD355

Removing/Installing Axle Seal

1. Remove the seal using a seal removal tool.

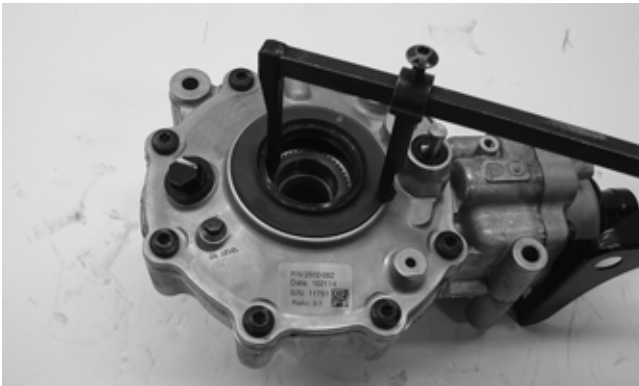

XR360

■NOTE: Prior to installing the seal, apply High-Performance #2 Molybdenum Disulfide grease to the seal outside diameter.

2. Using Gear Case Seal Installer Tool, evenly press the seal into the cover bore until properly seated.



GC060

CAUTION

Make sure the tool is free of nicks or sharp edges or damage to the seal may occur.

3. Repeat steps 1-2 for the opposite side.

INSTALLING DIFFERENTIAL

1. With the rubber boot (A), O-ring (B), and driveshaft bumper (C) set in place, place the differential assembly into position in the frame; then grease the splines for the front driveshaft and engage the front driveshaft to the differential; then gently slide the front differential toward the rear of the vehicle; then install the front differential vent hose.



MOD363

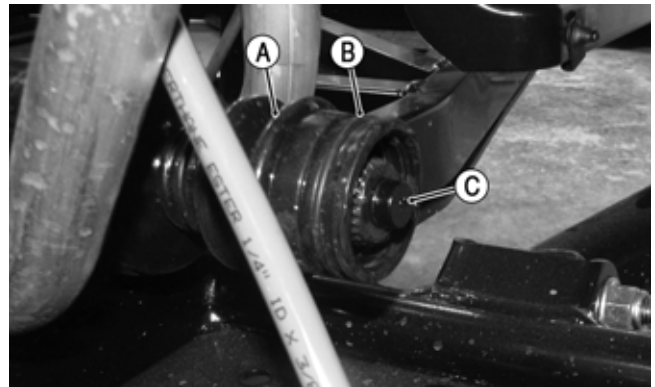

MOD362

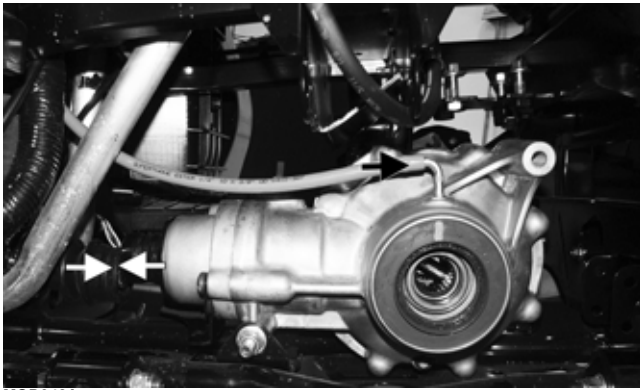

MOD348A

2. Install the lower differential mounting cap screws. Do not tighten at this time. Reconnect the front drive actuator connector above the front drive actuator (A) to the main harness and secure with nylon ties.



MOD347

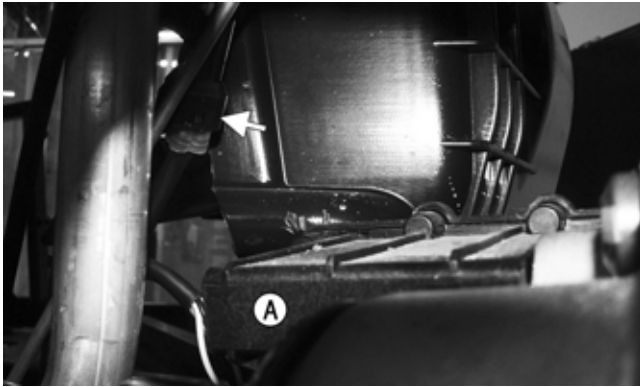

MOD344

3. Install the upper differential mounting bracket and cap screws. Tighten to 16 ft-lb (21.8 N-m).

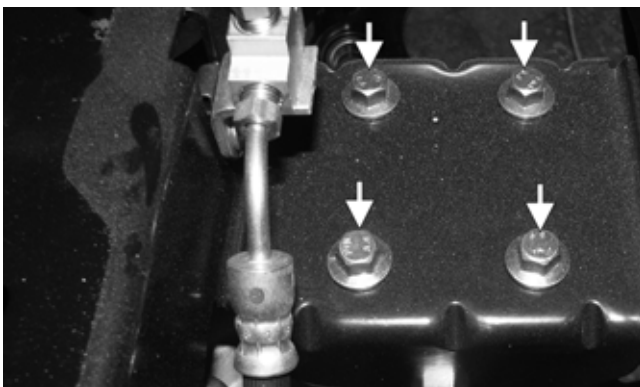

MOD346

4. Install the upper differential mounting cap screw with a new lock nut. Tighten to 45 ft-lb (61.2 N-m); then tighten the lower differential mounting cap screws to 16 ft-lb (21.8 N-m).

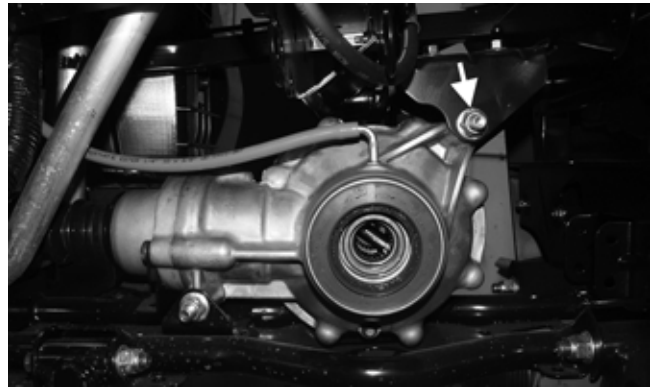

MOD345



MOD347

5. Remove the fill plug and pour the recommended amount of lubricant into the differential; then install the fill plug. Tighten to 16 ft-lb (21.8 N-m). Verify the location of the O-rings for the axles; then install the front axles by pushing the axle shaft (A) toward the inner CV joint housing (B) to release the “plunge” coupler; then while the axle shaft and the inner CV joint housing are pushed together install the axle to the differential. Repeat for the opposite side.

■NOTE: To ensure proper axle seating, give it a light pull; the axle should remain “clipped” in place.

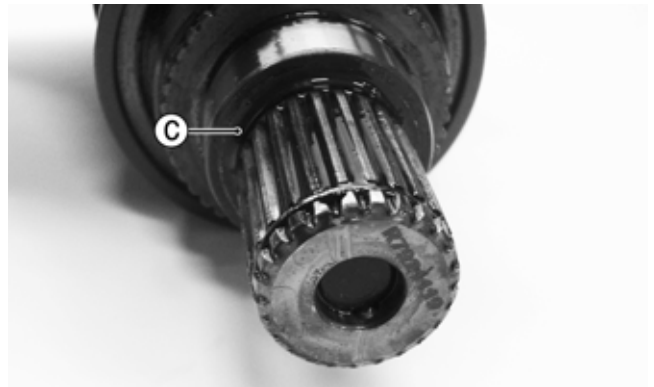

MOD502

Drive Axles

REMOVING REAR DRIVE AXLE

1. Remove the hubs (see Hub/Brake Disc in this section).
2. Remove the cap screw and lock nut securing the knuckle to the upper A-arm. Discard lock nut. Inspect cap screw and replace if damaged.



MOD350

6. Install the knuckle assemblies onto the axles and ball joints; then secure with two cap screws per side taking care not to damage the threads when installing. Tighten to 45 ft-lb (61.2 N-m).



MOD325

7. Secure the lower shock eyelets with cap screws and new lock nuts. Tighten to 45 ft-lb (61.2 N-m).

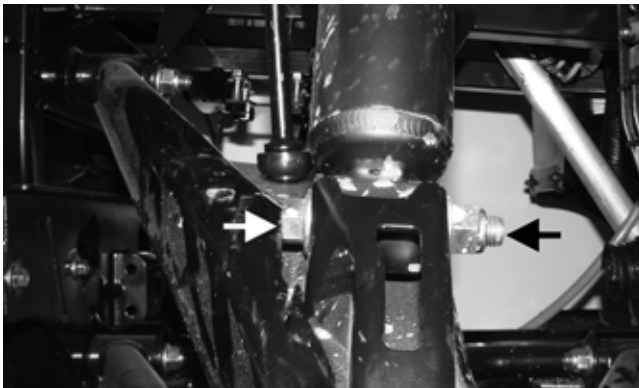

MOD334

8. Apply a light coat of multi-purpose grease to the hub splines; then install the hubs (see Hub/Brake Disc in this section).
9. Install the wheels and using a crisscross pattern, tighten the wheel nuts in 20 ft-lb (27.2 N-m) increments to a final torque of 100 ft-lb (136 N-m).
10. Remove the vehicle from the support stand.

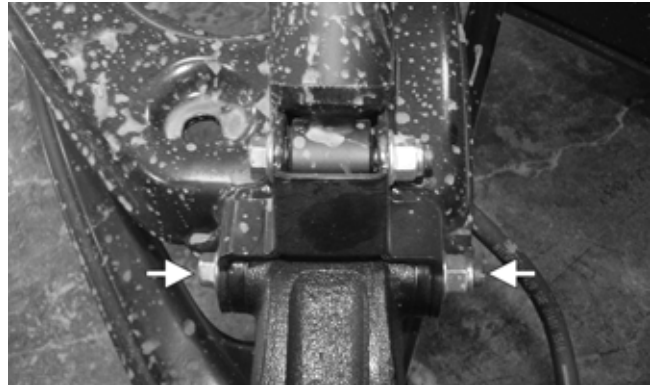

MOD367

3. While holding the drive axle stationary, use a rubber mallet, and tap the end of the axle free from the knuckle assembly; then pull the top of the knuckle out and down until it is free of the drive axle; then repeat for the other side.



MOD368

■NOTE: The axle shaft must be pushed into the inner CV joint straight.

4. Push the axle shaft (A) toward the inner CV joint housing (B) to release the “plunge” coupler; then while the axle shaft and the inner CV joint housing are pushed together remove the axle from the differential; then account for the O-ring. Repeat for the opposite side.



MOD350

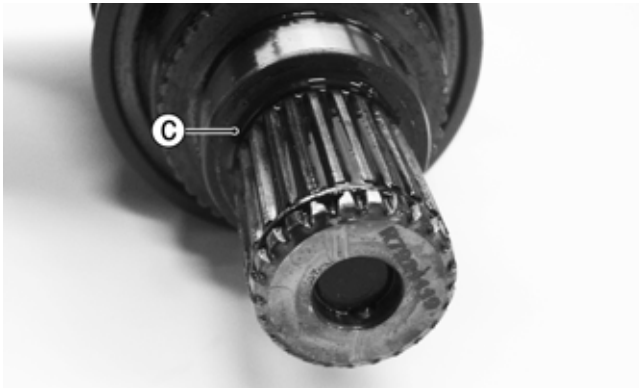

MOD502

REMOVING FRONT DRIVE AXLE

■NOTE: For removing a front drive axle, see Front Differential in this section.

CLEANING AND INSPECTING AXLES

■NOTE: Always clean and inspect the drive axle components to determine if any service or replacement is necessary.

1. Using a clean towel, wipe away any oil or grease from the axle components.



MOD513

2. Inspect boots for any tears, cracks, or deterioration.

■NOTE: If a boot is damaged in any way, it must be replaced with a boot kit.

DISASSEMBLING AXLES

■NOTE: Only the boots are serviceable on the axles; if any other component is worn or damaged, the axle must be replaced.

1. Using CV Boot Clamp Tool, remove and retain both clamps for assembly purposes.



MOD514

2. Use a suitable form of protection on the outside surface of the CV joint, such as a strip of rubber or duct tape; then place the CV joint housing into a vise.

CAUTION

Do not over tighten the vise when securing the CV joint housing, otherwise internal damage to the CV joint may occur.

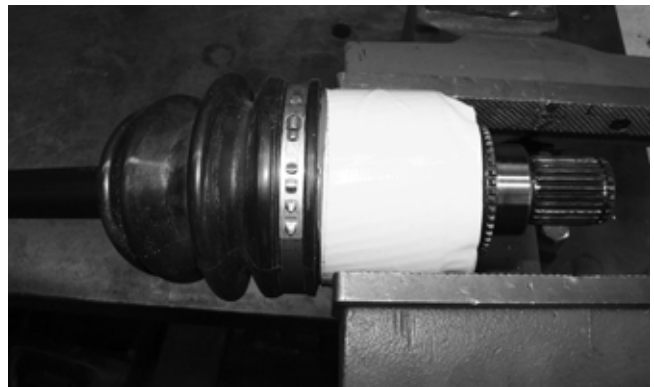

MOD515

3. To disengage the axle from the CV joint, sharply pull back on the axle; then slide the boot off of the axle.



MOD516

■NOTE: Steps 1-3 can be used to replace the out-board boot.

ASSEMBLING AXLES

1. Install the inner boot with the small clamp making sure the clamp is positioned correctly.

■NOTE: The boot is positioned correctly when the small end of the boot seats down into the recessed groove.

2. Using the boot clamp tool, secure the small clamp of the inner boot.



MOD516A

3. Apply 100 grams (2/3 of contents) of grease from the pack into the bearing housing.
4. Check the condition of the circlip on the end of the half shaft and replace if necessary. Engage the external splines on the end of the half shaft into the star-shaped inner race of the CV joint; then grasp the half shaft and seat it into the CV joint assembly by pressing it firmly into the CV joint assembly.

■NOTE: A light tap with a hammer might be required.

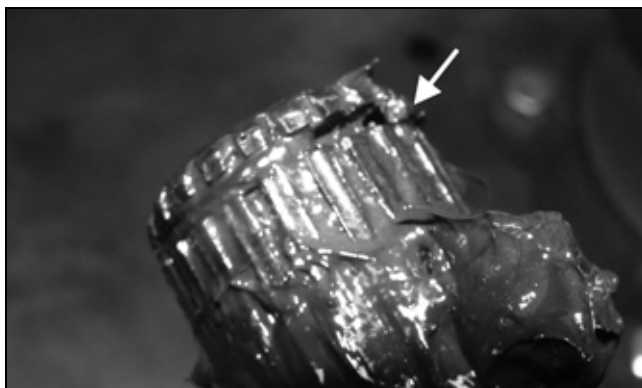

MOD517

5. Using the boot clamp pliers, install the large diameter boot clamp.



MOD514



MOD518

■NOTE: Steps 1-5 can be used to replace the outboard boot.

■NOTE: In the outboard boot, use the final 55 grams (1/3 of contents) of grease from the pack in the bearing housing.

INSTALLING REAR DRIVE AXLE

■NOTE: It is recommended to apply grease on the splines for the rear drive axles going into the transaxle. Prior to installing verify the location of the O-ring for the rear drive axles.

1. Push the axle shaft (A) into the inner CV joint housing (B) to release the lock ring; then while the axle shaft and the inner CV joint housing are pushed together slide the drive axle into place in the gear case.

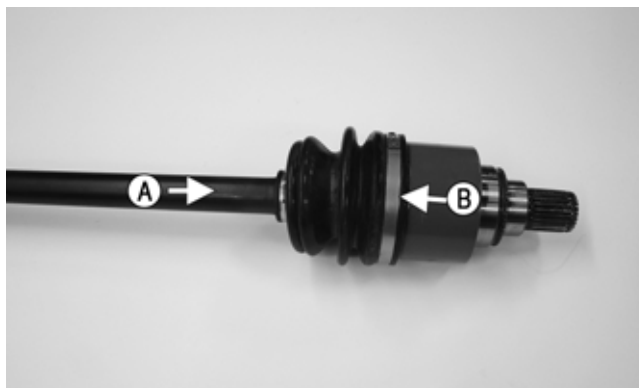

MOD350

■NOTE: To ensure proper axle seating, give it a light pull; the axle should remain "clipped" in place.

2. Swing the knuckle up and onto the drive axle; then place the knuckle into place in the upper A-arm. Secure the knuckle to the A-arm with cap screws and new lock nuts. Tighten to 45 ft-lb (61.2 N-m).
3. Install the hubs (see Hub/Brake Disc in this section).
4. Install the wheels and using a crisscross pattern, tighten the wheel nuts in 20 ft-lb (27.2 N-m) increments to a final torque of 100 ft-lb (136 N-m).
5. Remove the vehicle from the support stand and release the parking brake.

INSTALLING FRONT DRIVE AXLE

1. Verify the location of the O-rings (C) for the axles; then install the front axles by pushing the axle shaft (A) toward the inner CV joint housing (B) to release the “plunge” coupler; then while the axle shaft and the inner CV joint housing are pushed together install the axle to the differential; then position the drive axle in the gear case and steering knuckle.

■NOTE: To ensure proper axle seating, give it a light pull; the axle should remain “clipped” in place.

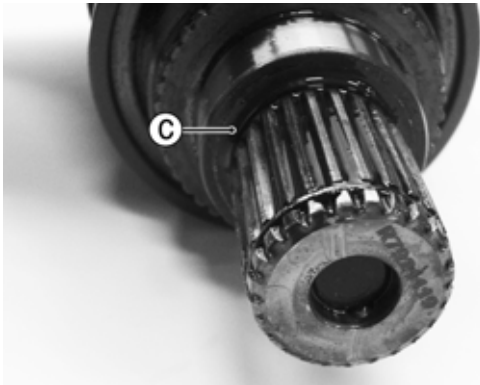

MOD502



MOD350

2. Insert the ball joints into the steering knuckles and secure with new cap screws and new lock nuts tightened to 45 ft-lb (61.2 N-m); then install the tie rods to the steering knuckles and tighten to 32 ft-lb (43.5 N-m); then secure the lower shock eyelet to the A-arm with a cap screw and a new lock nut. Tighten to 45 ft-lb (61.2 N-m).
3. Install the hubs (see Hub/Brake Disc in this section).
4. Install the wheels and using a crisscross pattern, tighten the wheel nuts in 20 ft-lb (27.2 N-m) increments to a final torque of 100 ft-lb (136 N-m). Repeat steps 1-4 for opposite side.
5. Remove the vehicle from the support stand.
6. Check the front differential lubricant level and add lubricant as necessary.

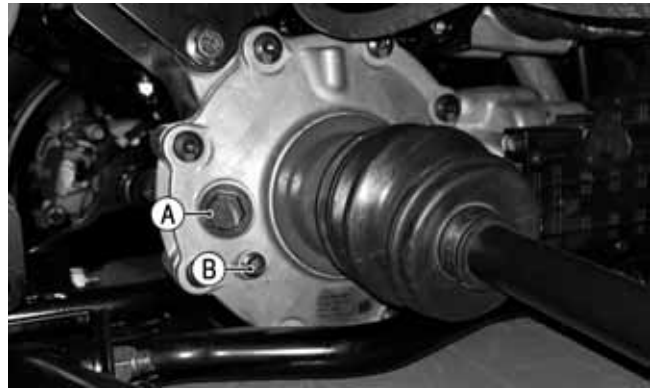

MOD073A

Driveshaft

REMOVING

1. Remove one of the two rear skid plate sections as described in the Skid Plate section.
2. Remove the carrier bearing (A) as described in the Carrier Bearing section.
3. Uncouple the driveshaft boot (B) from the transaxle front output. Account for the O-rings (C) for the driveshaft-to-transaxle coupler.

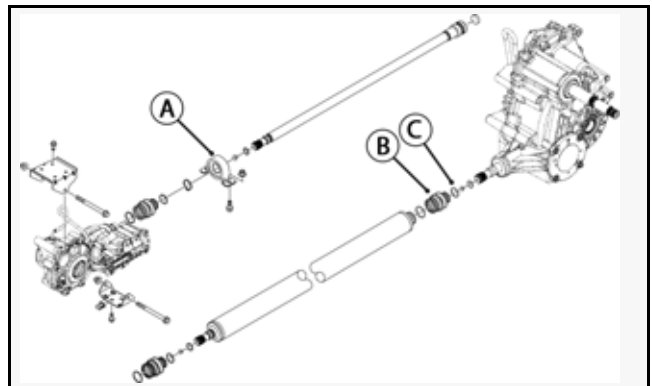

MODC080

4. Slide the driveshaft forward so the rear end of the shaft clears the cross member support.

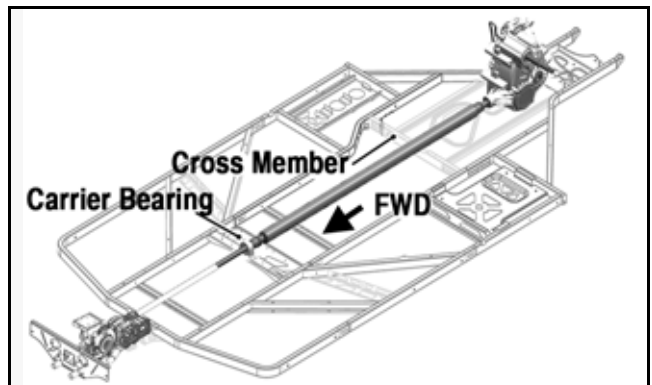

MODC081

5. Tilt the rear end of the driveshaft downward and slide the driveshaft backward and out of the chassis.

ASSEMBLY

1. Tilt the front of the driveshaft up and slide forward into the front differential space until it clears the rear cross member support.
2. Lightly coat the splines of the driveshaft with grease; then couple the driveshaft to the transaxle by gently sliding the driveshaft toward the rear of the vehicle. Verify the O-rings and boot are intact for the coupler.
3. Install the carrier bearing as described in the Carrier Bearing section.
4. Install removed skid plate as described in the Skid Plate section.

Transaxle

REPLACING SEALS

Output (Axle) Seals

■NOTE: The transaxle does not need to be removed for this procedure.

1. Support the vehicle on an appropriate stand; then remove a rear wheel and axle.
2. Using an awl and a mallet, pry the seal from the case taking care not to damage the seal bore.

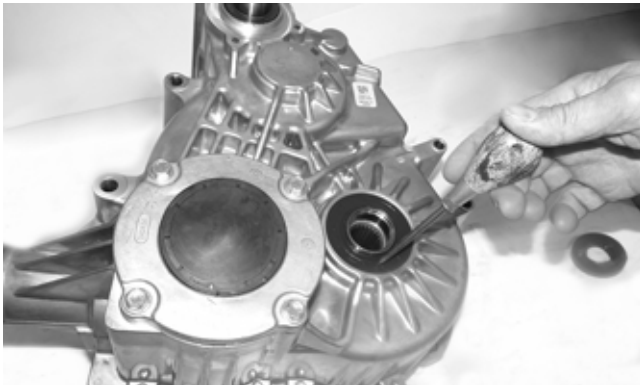

TA118

3. Wipe any oil or dirt from the seal area of the transaxle.
4. Using an appropriate seal installer and protector, install a new seal so it seats fully past the chamfer of the case — approximately 1.5-2.0 mm (0.06-0.08 in.) deep.

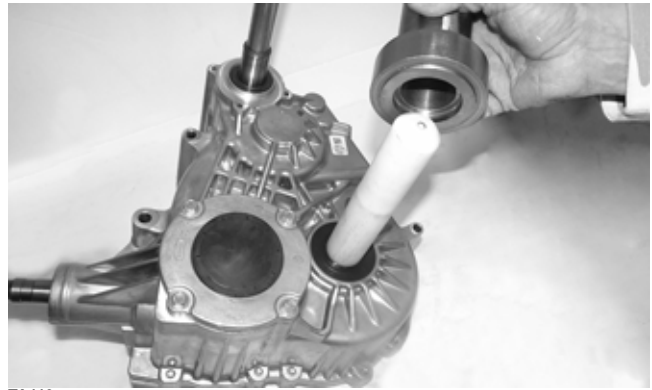

TA113

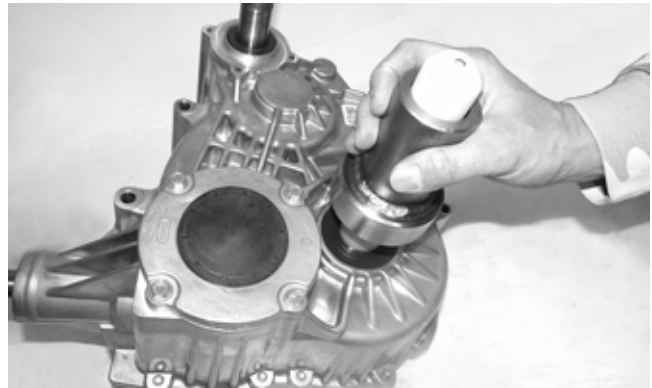

TA115

Input (Driven Clutch) Seal

■NOTE: The transaxle does not need to be removed for this procedure.

1. Support the vehicle on an appropriate stand; then remove the left rear wheel, the outer clutch cover, the clutches, and the inner clutch cover.
2. Using an awl and a mallet, pry the seal from the case taking care not to damage the seal bore.



TA109

3. Wipe any oil or dirt from the seal area of the transaxle.
4. Using an appropriate seal installer and protector, install a new seal so it seats flush with the case (0.5 mm deep).



TA110

Front Output Seal

■NOTE: The transaxle must be removed for this procedure.

1. Using an awl and a mallet, pry the seal from the case taking care not to damage the seal bore.



TA117

CAUTION

Do not drive the awl too far or bearing damage will occur.

2. Wipe any oil or dirt from the seal area of the transaxle.
3. Tape the splined portion of the pinion shaft to protect the seal; then using an appropriate seal installer, install the front output seal (approximately 0.5-1.0 mm deep).



TA129

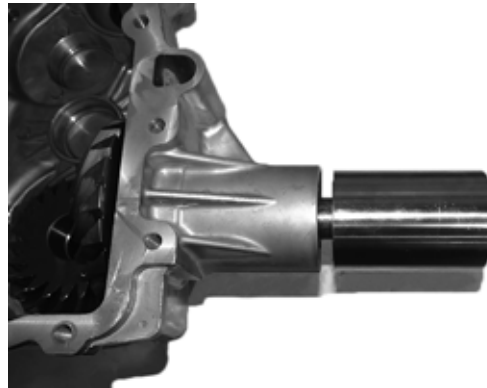

TA130

Pinion Plug

■NOTE: The transaxle does not need to be removed for this procedure.

1. Support the vehicle on an appropriate stand; then remove the left rear wheel and axle.
2. Using an awl and a mallet, pry the pinion plug from the case taking care not to damage the seal bore.

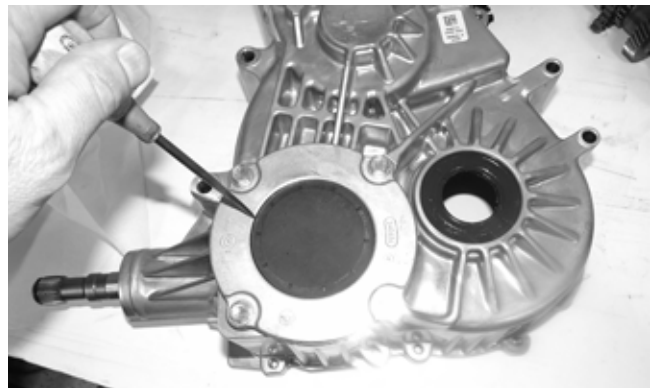

TA084

CAUTION

Do not drive the awl too far or bearing damage will occur.

3. Wipe any oil or dirt from the plug area of the transaxle.
4. Using an appropriate tool, lightly tap the plug so it seats fully past the chamfer of the case (approximately 1.0-1.5 mm deep).



TA132

REMOVING TRANSAXLE

1. Remove the cargo box; then remove both rear inner fenders; then remove both rear drive axles; then remove the two cap screws underneath the front differential.

■NOTE: Removal of front axles is not required.



MOD347

2. Remove the upper mount cap screw and lock nut for the front differential; then remove the four cap screws securing the upper differential mount; then remove the upper differential mount. Discard lock nut. Inspect cap screws and replace if damaged.



MOD345

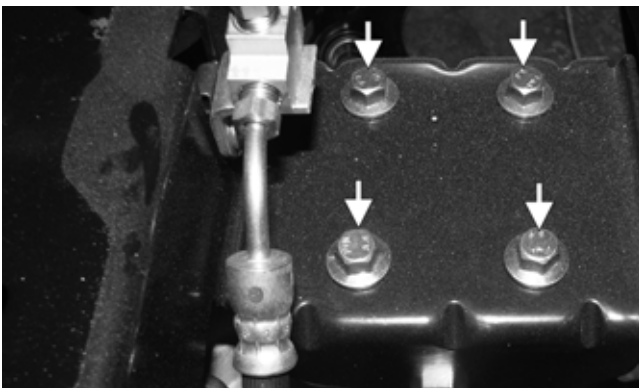

MOD346

3. Remove the drive belt, drive and driven clutches; then remove the clutch cover housing; then remove the flywheel housing, crankshaft position sensor bracket with crankshaft position sensor, PTO stub shaft, and flywheel.



MOD544B

4. With a suitable strap put a slight upward tension on the engine; then disconnect the shift cable from the transaxle.

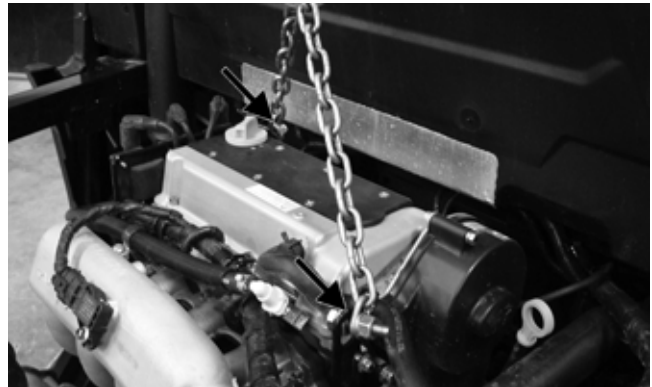

MOD546

5. Remove the nylon straps and disconnect the electrical connections to the transaxle.

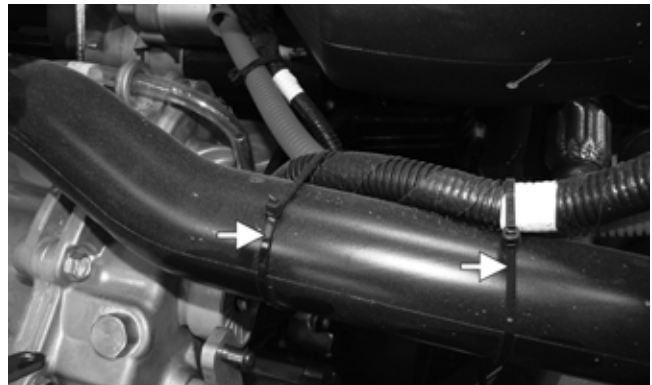

MOD374

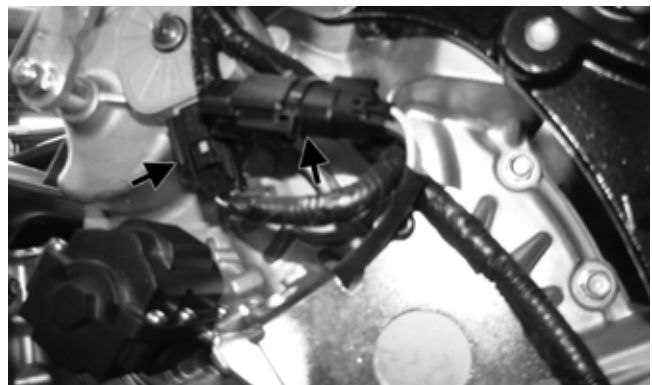

MOD375



MOD376

6. Remove the two cap screws securing the transaxle to the engine. Account for the spacers.



MOD544

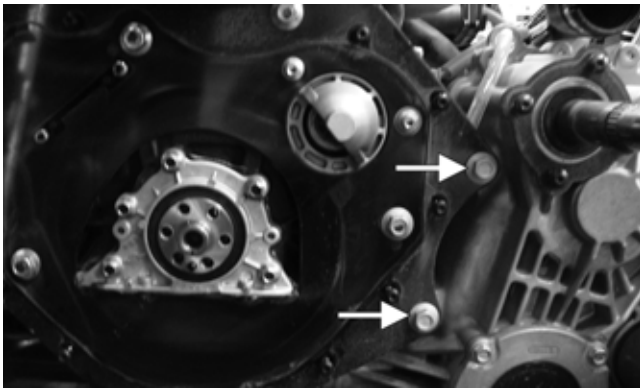

MOD563

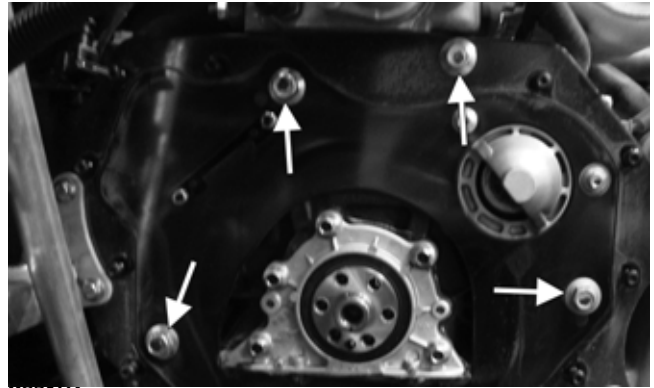

MOD544A

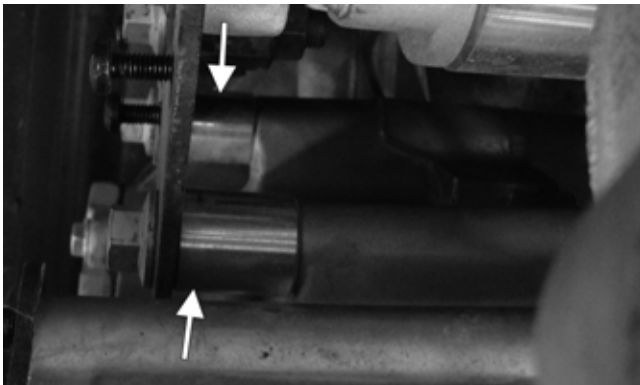

MOD554

7. Remove the two cap screws securing the starter to the engine backplate; then use a suitable strap to support the starter; then remove the two cap screws securing the engine backplate to the front engine mount; then remove the four cap screws securing the engine backplate; then remove the engine backplate.

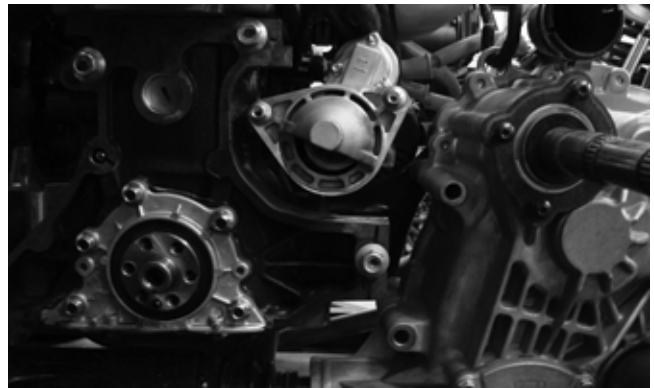

MOD565

8. Uncouple the driveshaft from the transaxle by gently sliding the front differential with the driveshaft toward the front of the vehicle. Account for the O-rings and boot for the driveshaft-to-transaxle coupler.

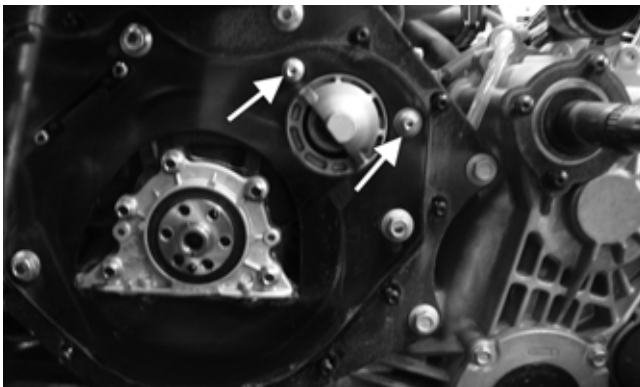

MOD563A



MOD564

- Remove the rear transaxle mount to frame cap screws and lock nuts (A); then gently slide the transaxle toward the front of the vehicle and remove the rear transaxle to transaxle mount cap screws and lock nuts (B); then being careful not to damage any items, gently remove the transaxle. Discard lock nuts. Inspect cap screws and replace if damaged.

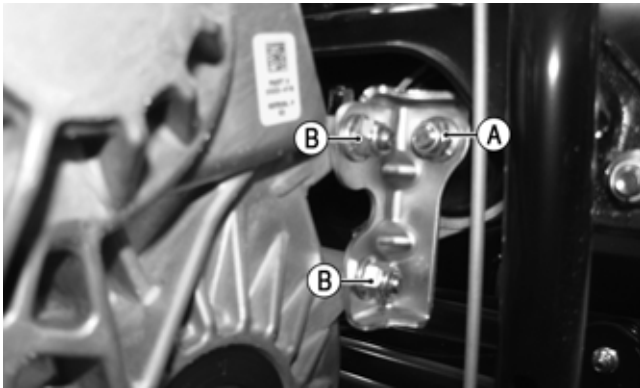

MOD380

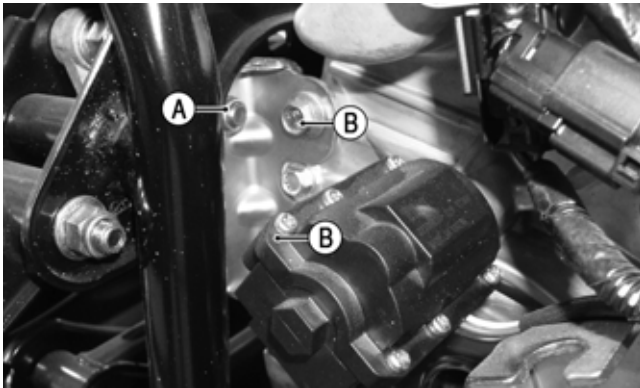

MOD381

SEPARATING HALVES

- With the transaxle on a bench, drain the fluid into a suitable pan.



TA004

■NOTE: Tip the transaxle toward the drain to get any remaining fluid.

■NOTE: Install the drain plug and tighten to 18 ft-lb.

- Lay the transaxle flat on the bench; then remove the 19 mm detent (gold plug) near the gear position switch. Account for the spring and O-ring.



TA012A

- Remove and discard the lock nut securing the bell crank; then using two screwdrivers, pry the bell crank off the shift shaft.



TA012B

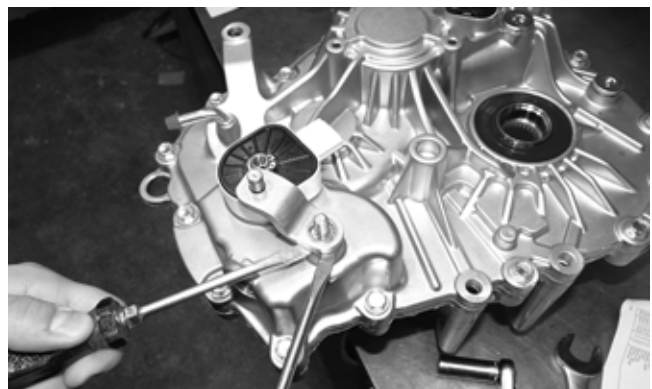

TA027

- Remove the clip securing the gear position switch. Gently pry the switch off the shift rail and account for the wave washer.
- Remove the screws securing the case halves together.
- While prying the two halves apart with an assistant, use a rubber mallet to gently tap the shift shaft (A), shift drum (B), and output shaft (C) into the lower half.

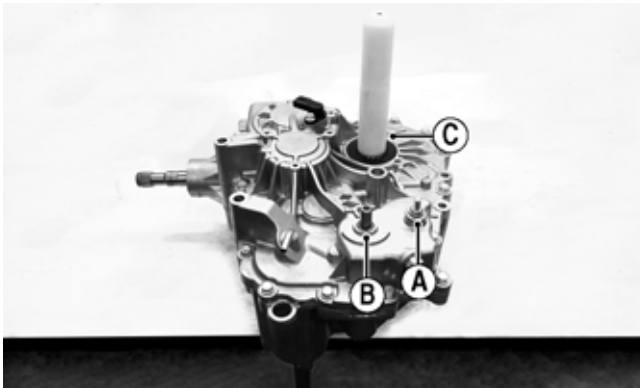

TA131A

■NOTE: Use a suitable bearing seal protection tool when driving the bearing and gears into the lower half of the transaxle.

7. Clean any silicone residue from the case halves.

DISASSEMBLING HALVES

1. Remove the shift shaft assembly and the detent.

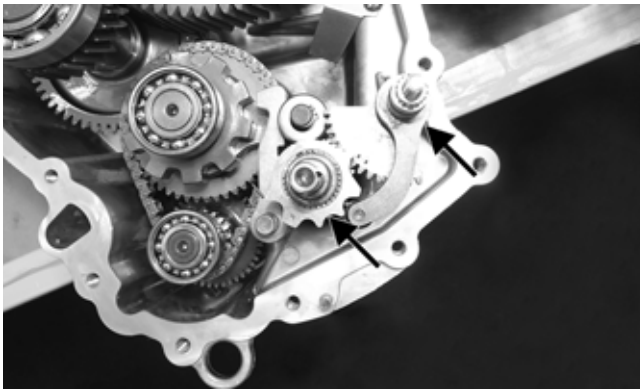

TA006A

2. Remove the park pawl with dowel pin and account for the spring.



TA028B

3. Remove the output gear assembly with bearings.

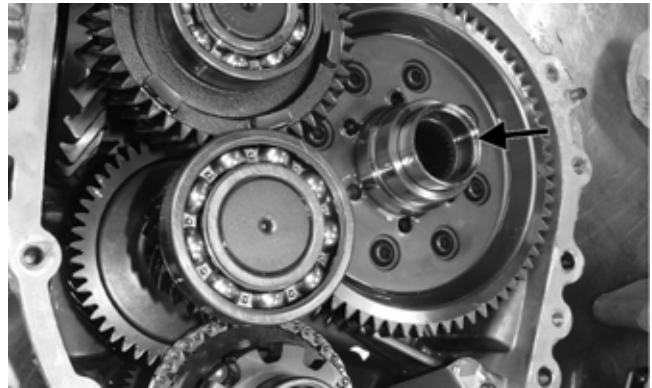

MOD383

4. Lift on the shift rail assembly to disengage the rail assembly from the case and rotate the rail away from the shift drum; then remove the shift drum assembly.

■NOTE: Spread the shift forks while removing.

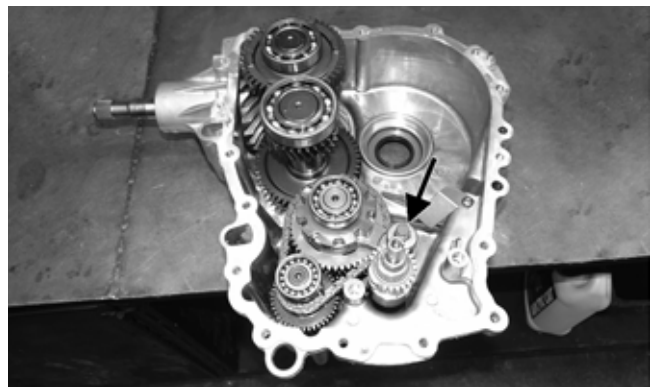

TA022A

5. Using an assistant, lift and remove all remaining shafts simultaneously.



TA059

6. Place the transaxle upright on the bench and dump any remaining fluid into the pan.

⚠ AT THIS POINT

If the pinion shaft and gear are not being serviced or replaced, no further disassembling is required.

7. With the transaxle flat on the bench, remove the four screws securing the pinion gear assembly.

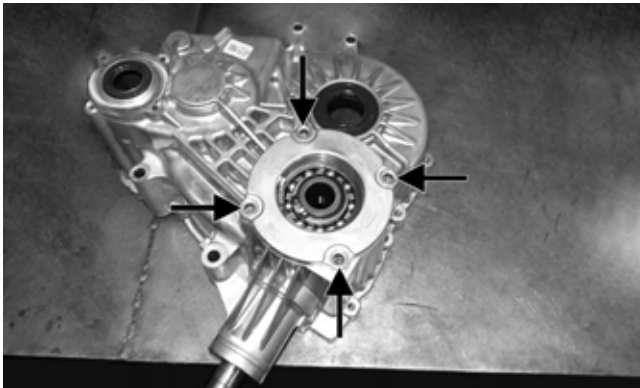

TA025A

8. Pry the pinion gear assembly to remove it from the case. Account for the shim.

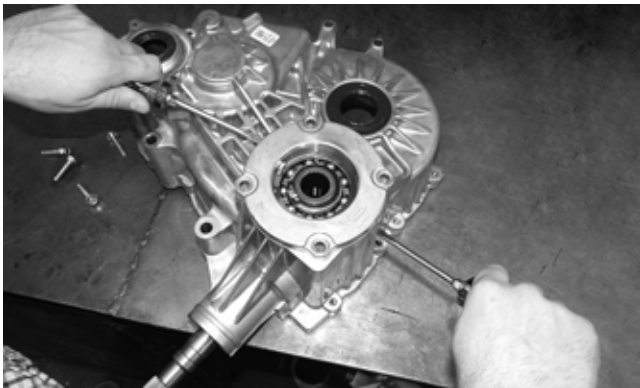

TA029

9. If the pinion shaft or bearing are being removed, use an awl and mallet to pry the front output seal off the case.

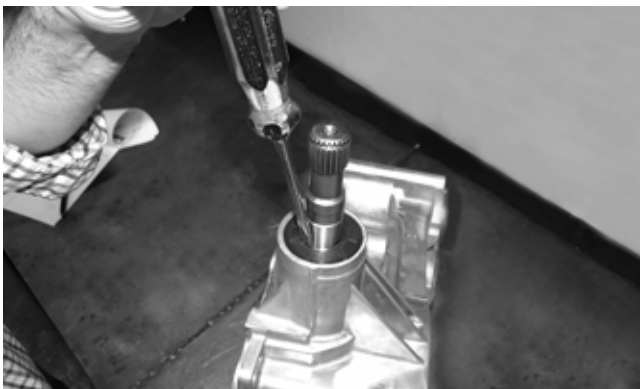

TA009

CAUTION

There is a ball bearing below the pinion seal. Use caution not to damage the bearing while removing the seal.

■NOTE: The pinion seal must be replaced if removed.

10. Remove the inner snap ring on the front output shaft; then using a mallet, tap the front output shaft down into the case half. Account for the shim.



TA073A

CAUTION

When tapping the output shaft, make sure not to drop the shaft when it releases from the bearing to avoid gear damage.

11. Remove the outer snap ring and shim securing the ball bearing; then using an appropriate tool, remove the bearing.

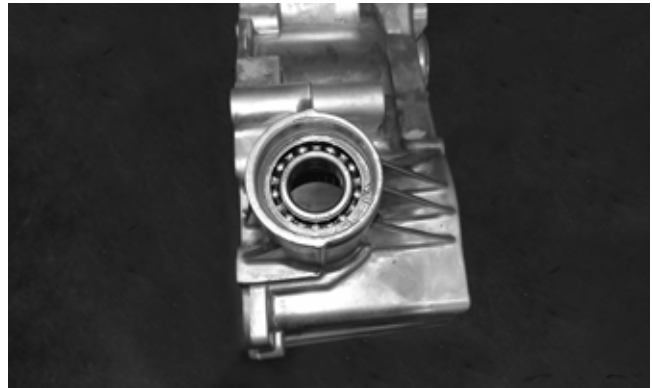

TA013

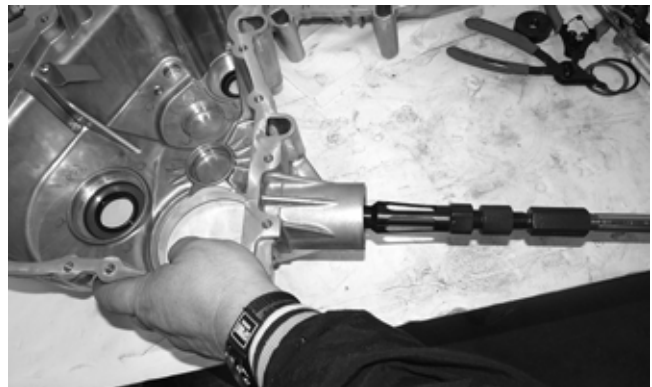

TA127

SERVICING COMPONENTS

■NOTE: If any bearing is removed, install a new bearing using a suitable press.

■NOTE: Keep all components in order for assembling purposes.

A. Output Gear

1. Inspect the bearings for free and smooth turning. If either bearing does not turn freely, it must be replaced.

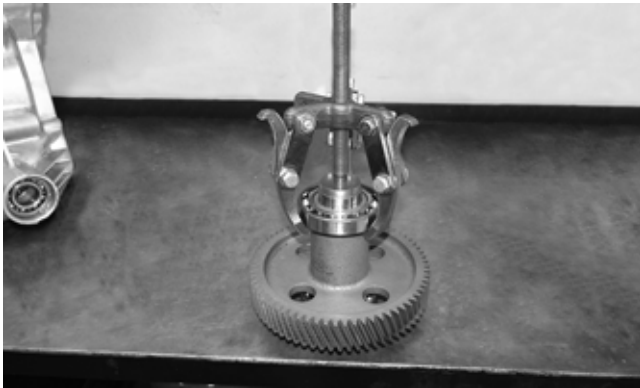

TA016

2. Inspect the gear teeth for nicks, cracks, chips, or signs of wear. If any are present, the gear must be replaced.

B. Intermediate Shaft

1. Inspect the bearing for free and smooth turning. If the bearing does not turn freely, it must be replaced.

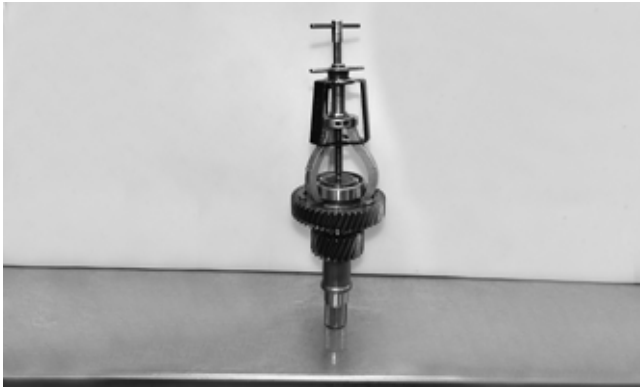

TA035

2. Inspect the gear teeth for nicks, cracks, chips, or signs of wear. If any are present, the gear must be replaced.



TA036

3. Inspect the shaft gear teeth for nicks, cracks, chips, or signs of wear. If any are present, the shaft must be replaced.

C. Shift Shaft Rail

1. Inspect the shift forks for nicks, cracks, chips, or signs of wear. If any are present, the forks must be replaced.

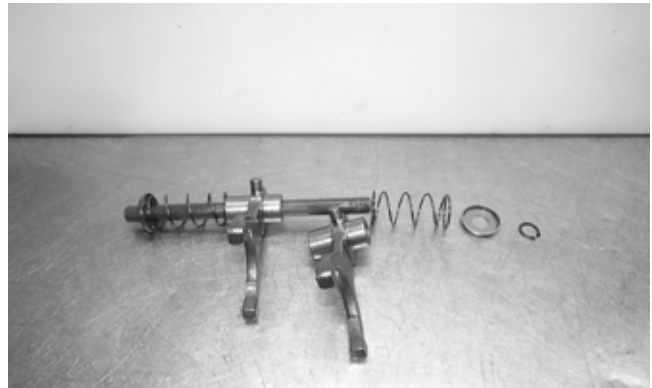

TA041

2. Inspect the rail for nicks, cracks, chips, or signs of wear. If any are present, the rail must be replaced.

D. Shift Shaft

Inspect the gear for nicks, cracks, chips, or signs of wear. If any are present, the gear must be replaced.

E. Idler Shaft

1. Inspect the bearings for free and smooth turning. If either bearing does not turn freely, it must be replaced.



TA033

2. Inspect the gear teeth for nicks, cracks, chips, or signs of wear. If any are present, the gear must be replaced.



TA034

3. Inspect the shaft gear teeth for nicks, cracks, chips, or signs of wear. If any are present, the shaft must be replaced.

F. Shift Drum

1. Remove the snap ring and washer; then pull the cam off the shift drum.

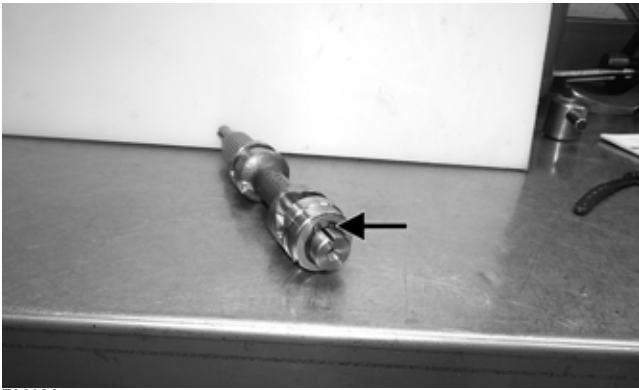

TA038A

2. Inspect the cam groove for signs of wear. If present, replace the cam.



TA133A

3. Check the shaft splines for nicks, cracks, chips, or signs of wear. If any are present, the shift drum must be replaced.



TA039

4. Check the detent star (A) and shift drum gear (B) for nicks, cracks, chips, or signs of wear. If any are present, the detent star must be replaced.

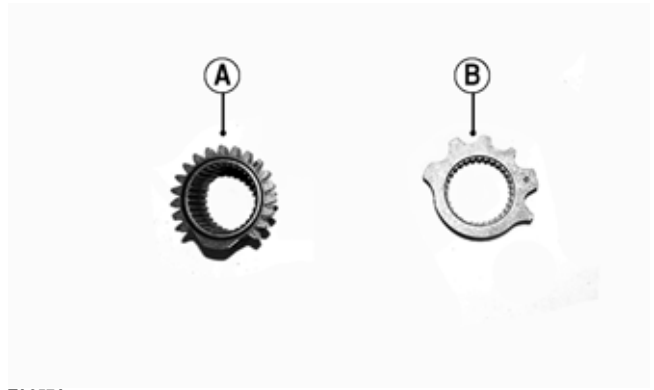

TA057A

5. Install the spring into the shift drum.



TA121

6. Rotate the cam clockwise so the tab of the spring installs into the shift drum groove. Install the washer to retain the spring.



TA122A

7. While holding pressure on the washer, rotate the cam counterclockwise to lock the cam onto the shift drum.

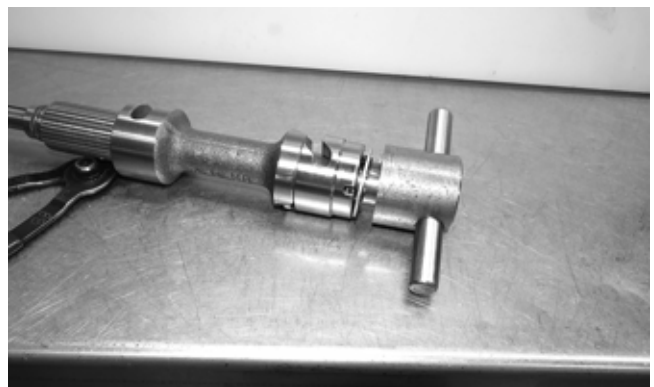

TA040

8. Install the snap ring.

G. Reverse Shaft

1. Inspect the bearings for free and smooth turning. If either bearing does not turn freely, it must be replaced.

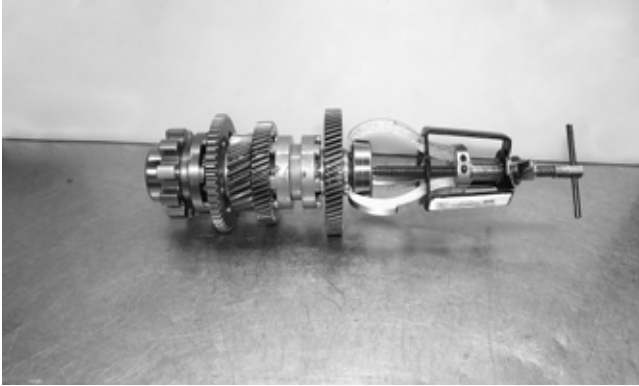

TA048

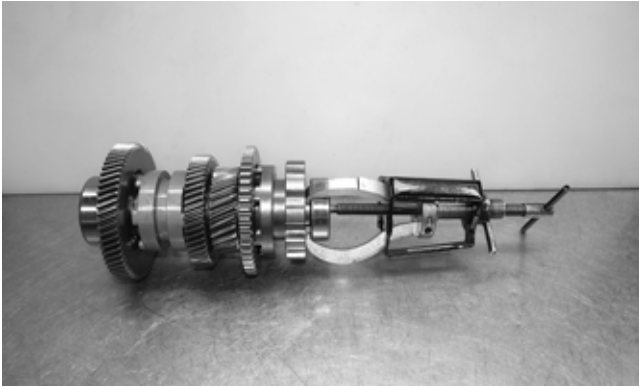

TA055

2. Inspect the gear teeth for nicks, cracks, chips, or signs of wear. If any are present, the gear must be replaced.



TA049

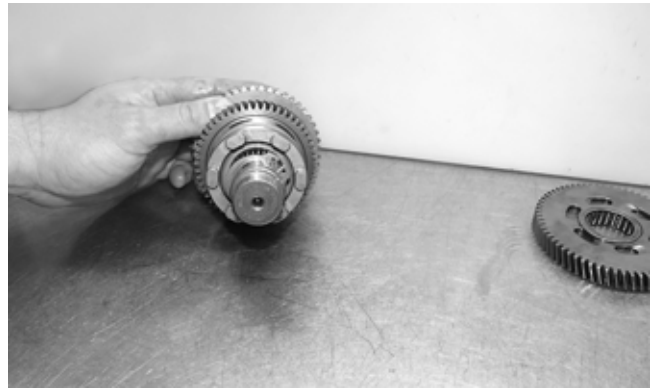

TA050

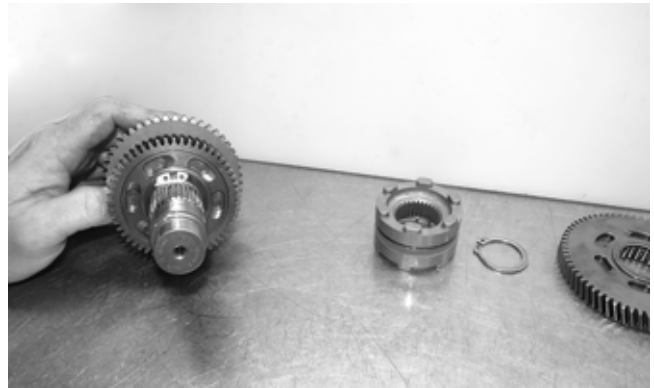

TA051

3. Inspect the shaft gear teeth for nicks, cracks, chips, or signs of wear. If any are present, the shaft must be replaced.



TA052

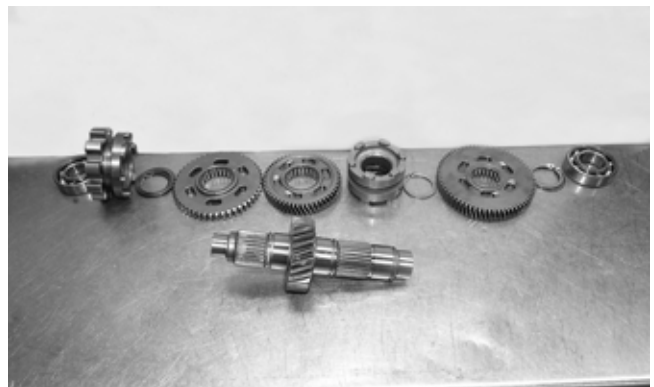

TA053

4. Inspect the dogs for nicks, cracks, chips, or signs of wear. If any are present, the dog must be replaced.



TA054

H. Input Shaft

1. Inspect the bearings for free and smooth turning. If either bearing does not turn freely, it must be replaced.

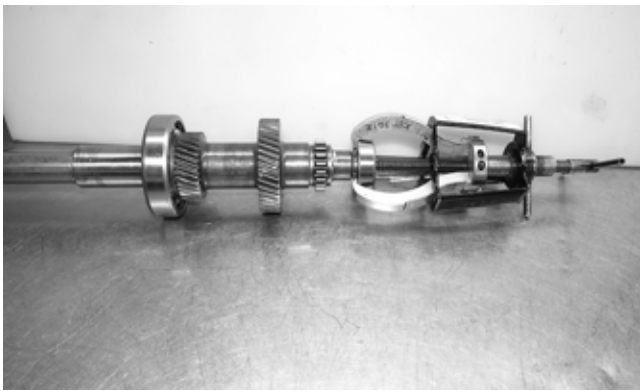

TA042

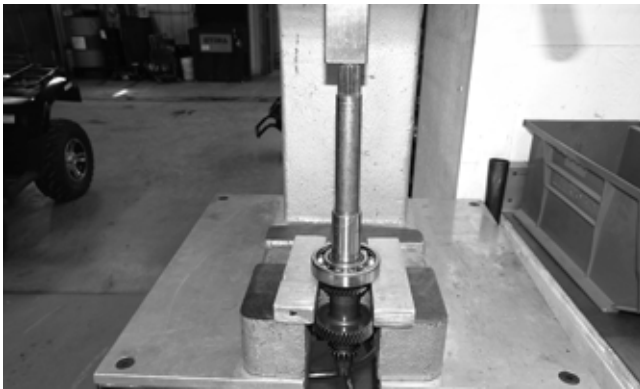

TA044

2. Inspect the sprocket teeth for nicks, cracks, chips, or signs of wear. If any are present, the sprocket must be replaced.



TA043

3. Inspect the shaft gear teeth for nicks, cracks, chips, or signs of wear. If any are present, the shaft must be replaced.



TA045

I. Pinion Assembly

Inspect the teeth of the pinion gear and front output shaft. If any chipping, nicks, wear, or damage are observed, the pinion assembly must be replaced.

Turn the pinion gear by hand. If any sticking or binding is observed, the bearing must be replaced. Use the following procedure:

1. Using an awl, pry the plug from the case. Discard the plug.

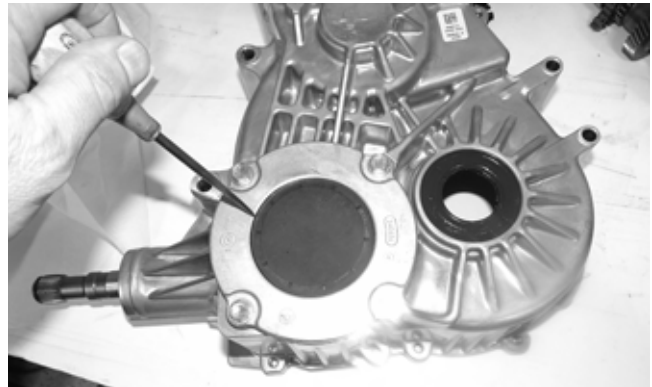

TA084

CAUTION

Do not drive the awl too far or bearing damage will occur.

2. Remove the small inner snap ring and account for the shim.

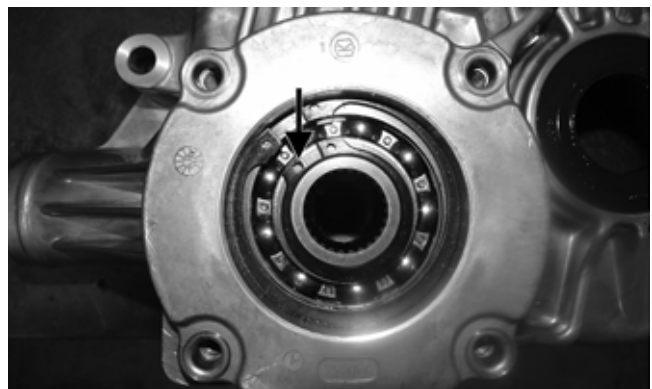

TA082A

3. With the aid of an assistant and using an appropriate driver, remove the gear.



TA031

4. Remove the large outer snap ring and account for the shim.



TA086

5. Using an appropriate bearing driver, press the bearing from the housing.



TA081

6. Using an appropriate bearing installer, install a new bearing into the housing.

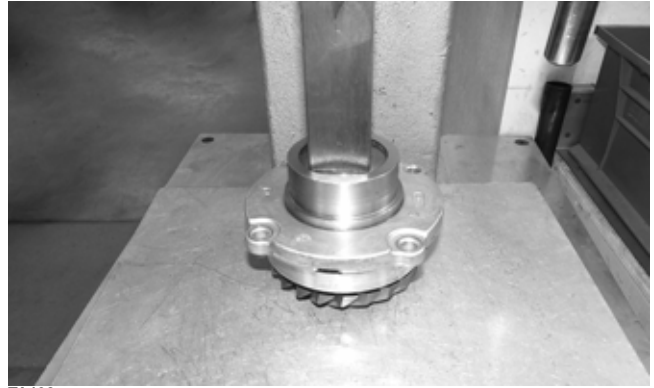

TA132

7. Install the large outer snap ring with the shim.



TA086

8. Install the gear into the housing.



TA077

9. Install the small inner snap ring with shim.

BACKLASH

⚠ AT THIS POINT

If the pinion shaft or gear were replaced or serviced, backlash must be checked. If not, proceed to ASSEMBLING HALVES in this section.

1. Install the pinion shaft into the case. With the appropriate shim in place, secure with the snap ring.

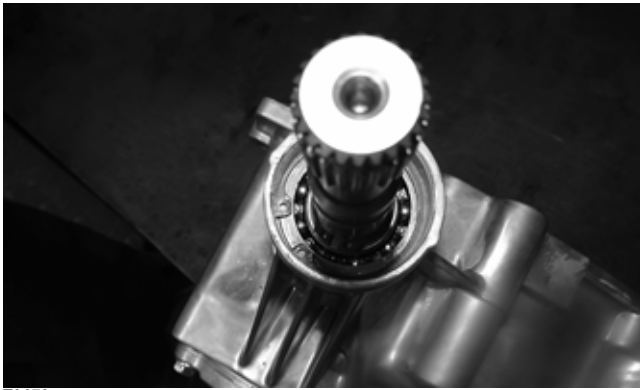

TA073

■NOTE: To determine the appropriate shim, start with the thickest shim and install the snap ring. If the snap ring will not fit in the groove, remove the shim and install the next size smaller shim. Continue until the snap ring can be installed.

2. With the appropriate shim in place and the O-ring coated with molybdenum grease, install the pinion gear assembly into the case half and secure with the four screws. Tighten to 20 ft-lb (27.2 N-m).

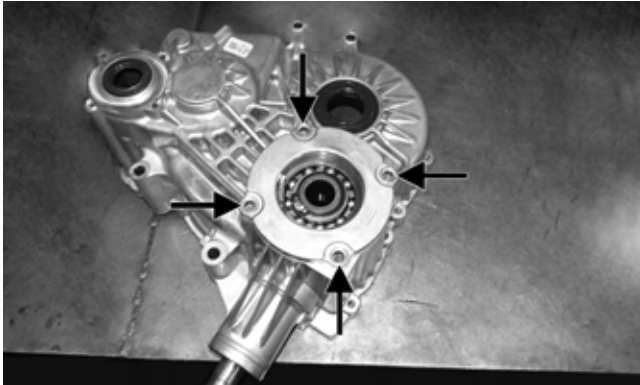

TA025A

■NOTE: To determine the appropriate shim, proceed to step 3.

3. Using an appropriate tool, lock the pinion gear in place.



TA124A

4. Mount a dial indicator so the tip is contacting a tooth on the pinion shaft.

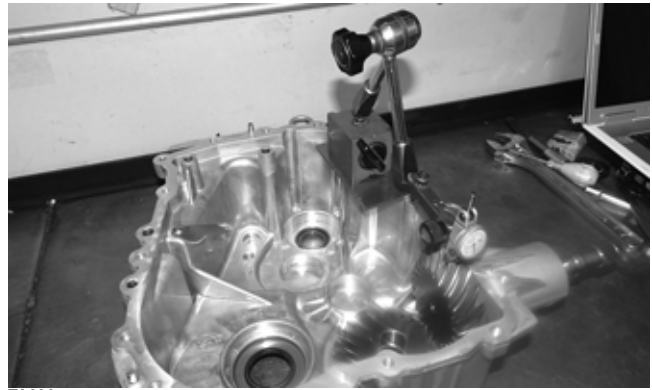

TA096

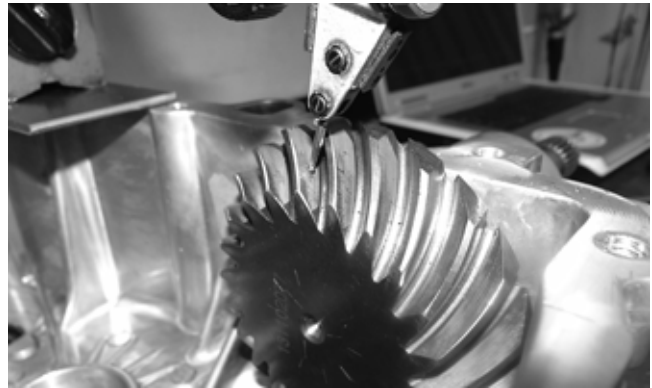

TA095

5. While pushing in on the front output shaft, and while rocking the shaft back and forth, note the maximum backlash reading on the gauge.

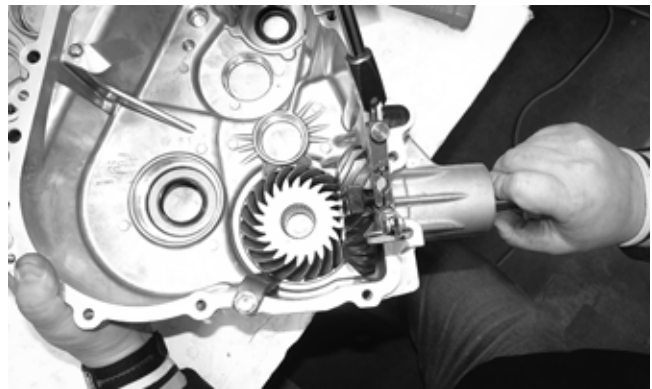

TA125

6. Acceptable backlash range is 0.076-0.241 mm (0.003-0.0095 in.).

■NOTE: If backlash measurement is within the acceptable range, no correction is necessary.

7. If backlash measurement is less than specified, remove the existing shim and install a new thicker shim (from shim kit).

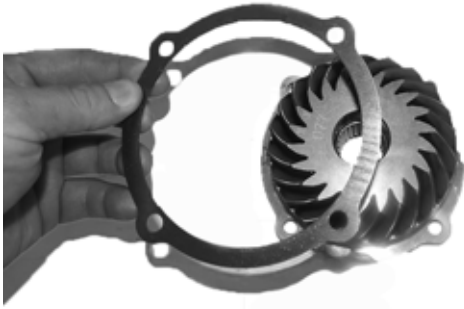

TA102

8. If backlash measurement is more than specified, remove the existing shim and install a thinner shim.

■NOTE: Continue to remove, measure, and install until backlash measurement is within tolerance. Note the following chart:

| Backlash Measurement | Shim Correction |
|--------------------------------------|-------------------------|
| Under 0.076 mm (0.003 in.) | Increase Shim Thickness |
| At 0.076-0.241 mm (0.003-0.0095 in.) | No Correction Required |
| Over 0.241 mm (0.0095 in.) | Decrease Shim Thickness |

9. Tape the splined portion of the pinion shaft to protect the seal; then using an appropriate seal installer, install the front output seal so it seats fully past the chamfer of the case.

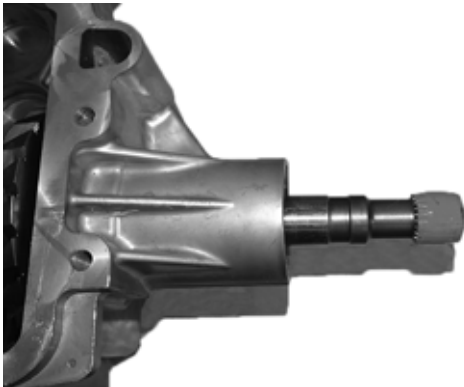

TA129

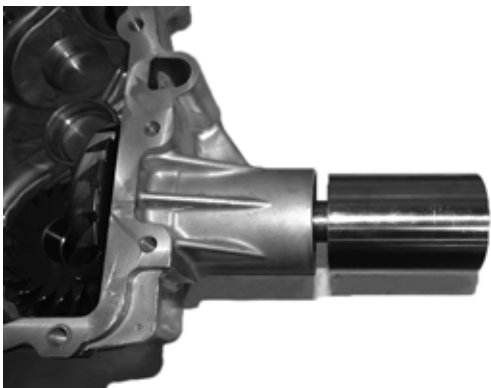

TA130

ASSEMBLING HALVES

1. Install the intermediate shaft and idler shaft into the case only partially. Do not seat the shafts completely into the case at this time.



TA056

2. With the aid of an assistant and with the gear forks in position, install the input shaft and reverse shaft with chain as an assembly.

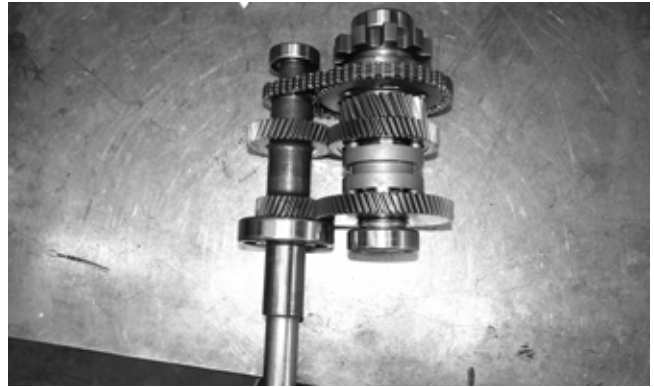

TA058



TA059

■NOTE: Make sure the shift fork pins face the installer.

■NOTE: Engage all four shafts before seating them simultaneously into the case.

■NOTE: Ensure the chain stays engaged in the sprocket teeth.

■NOTE: The shift shaft rail should remain unseated at this point.

3. Install the shift drum into the case; then engage the fork tabs into the grooves in the shift drum.



TA062

- Pinch the forks together and slide the rail into position in the case.



TA063

- Install the output gear. Use slight force to seat it and ensure the gear teeth engage with the intermediate shaft.



MOD384

- Install the park pawl with dowel and spring.



TA074



TA065A

- Install the shift drum gear onto the shift drum aligning the appropriate splines of the drum with the gear.

- Install the shift shaft gear onto the shift shaft with the timing marks facing up; then install into the case with the gear aligning with the shift drum gear.



TA066A

■NOTE: Rotate the shift drum and the shift shaft to ensure the timing marks are correctly aligned.

- Install the star detent over the shift drum aligning the appropriate splines of the detent with the shaft splines and the dot facing up.



TA134A

- Install an appropriate bearing seal protector tool onto the output shaft.



MOD384A

11. Apply a coat of Loctite #5699 to the case; then ensuring the shift shaft (O-ring lightly coated with grease) and shift rail are correctly seated; install the axle lock collar (A) on the cover and the axle lock solenoid (B); then install the cover.

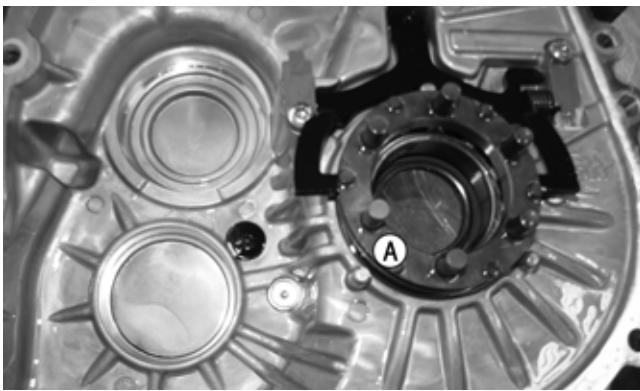

MOD388

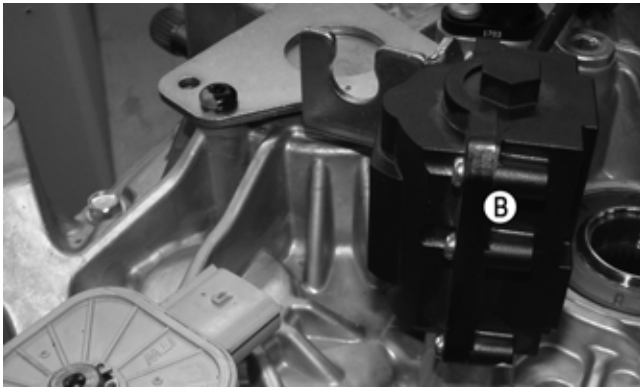

MOD389



TA068

■NOTE: It will be necessary to tap the cover onto the case using a rubber mallet. Ensure the alignment pins are properly oriented.

12. Secure the cover with the cap screws and tighten to 20 ft-lb (27.2 N-m).

13. Install the detent (gold plug) with spring and O-ring. Tighten to 20 ft-lb. (27.2 N-m).



MOD385

14. Align the shaft and the alignment pin on the gear position switch to the transaxle case; then install the gear position switch. Secure with the wave washer and snap ring.



MOD386

15. Install the bell crank being sure to correctly align the splines of the bell crank and shift shaft and secure with a new lock nut. Tighten to 15 ft-lb (20.4 N-m).

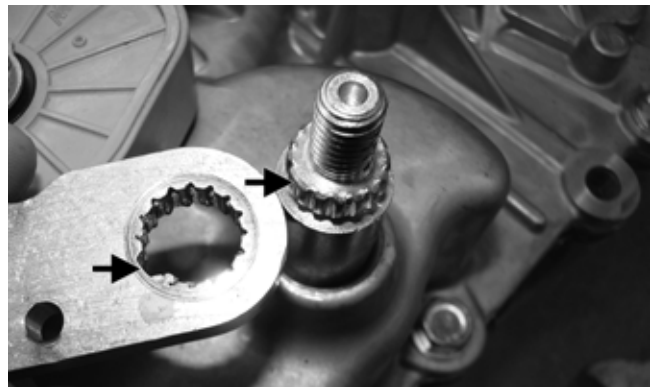

MOD387

■NOTE: Ensure the transaxle is in neutral by turning the input shaft (A). It should turn freely and the front output shaft (B) should not turn.

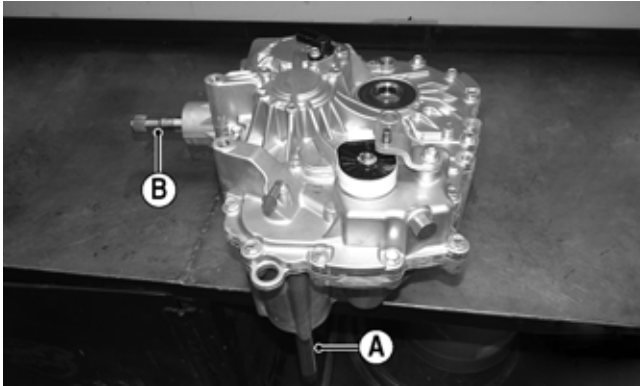

TA012C

16. Using an appropriate seal installer, gently install a new plug over the pinion gear assembly so it fully seats past the chamfer — approximately 1.0-1.5 mm (0.04-0.06 in.) deep.

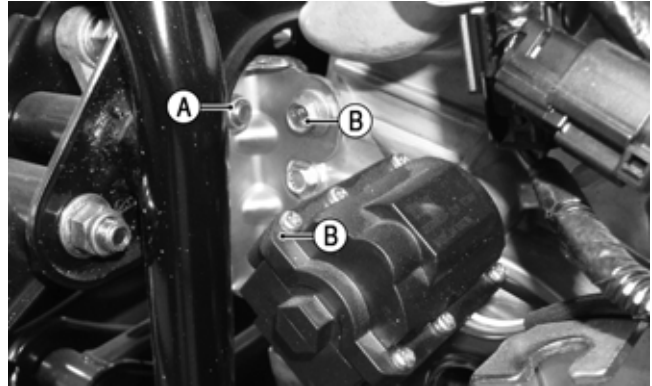

MOD381

3. Lightly coat the splines of the driveshaft with grease; then couple the driveshaft to the transaxle by gently sliding the front differential with the driveshaft toward the rear of the vehicle. Verify the O-rings and boot are intact for the coupler



TA135A

17. Add the correct amount of Synthetic Transaxle Fluid with EP to the transaxle. Verify fluid is level with the bottom threads of the fill plug hole. Install the fill plug and tighten to 18 ft-lb (24.5 N-m).

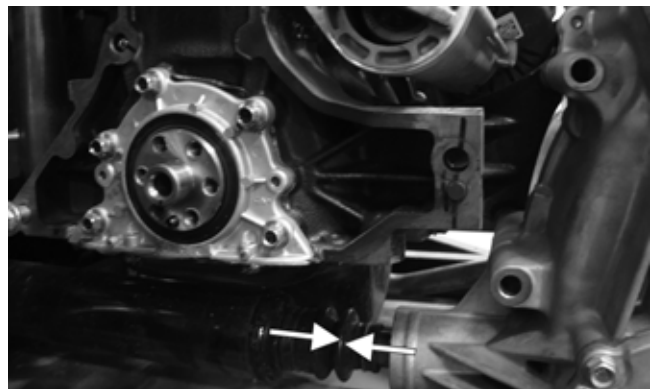

MOD564A

4. Clean the engine backplate; then apply black RTV silicone to the engine in the areas indicated; then position the engine backplate into place; then install the four cap screws securing the engine backplate to the engine and tighten to 51.7 ft-lb (70 N-m).

INSTALLING

1. Position the transaxle into the chassis, being careful not to damage any items.
2. Install the rear transaxle mount; then install the rear transaxle mount cap screws with new lock nuts (B); then tighten to 45 ft-lb (61.2 N-m); then gently slide the transaxle toward the rear of the vehicle; then install the rear transaxle mount to frame cap screws with new lock nuts (A). Tighten to 45 ft-lb (61.2 N-m).

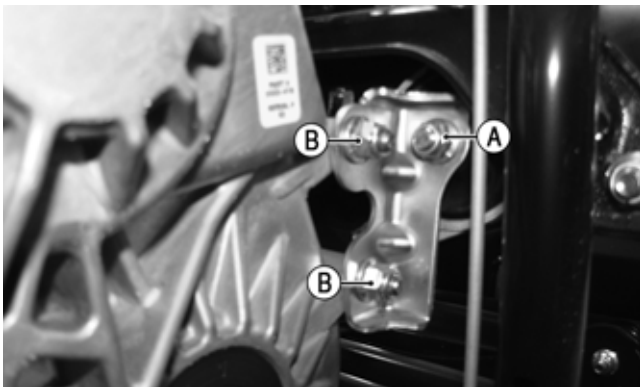

MOD380

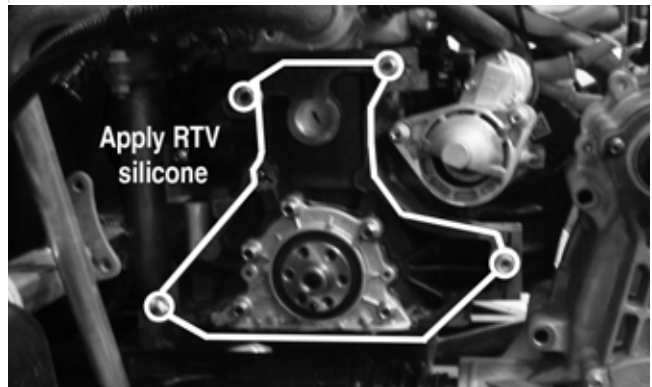

MOD605

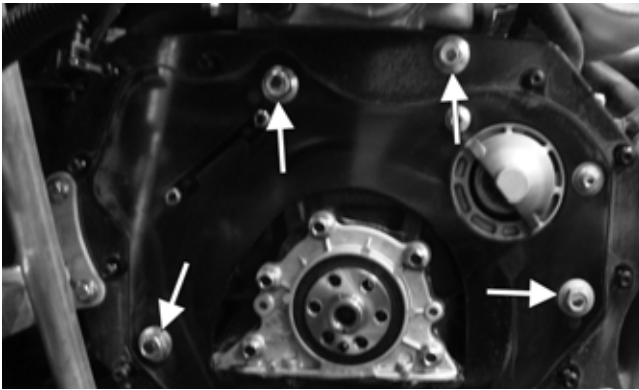

MOD544A

5. Install the two cap screws with blue Loctite #243 securing the backplate to the front mount and tighten to 51.7 ft-lb (70 N-m); then position the starter into place and install the two cap screws securing the starter to engine backplate; then tighten to 14.8 ft-lb (20 N-m).

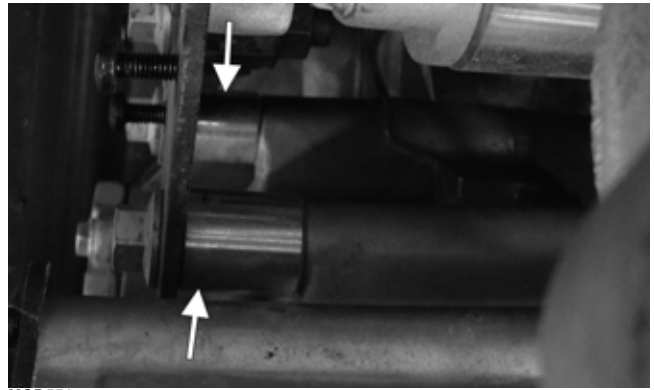

MOD554



MOD544

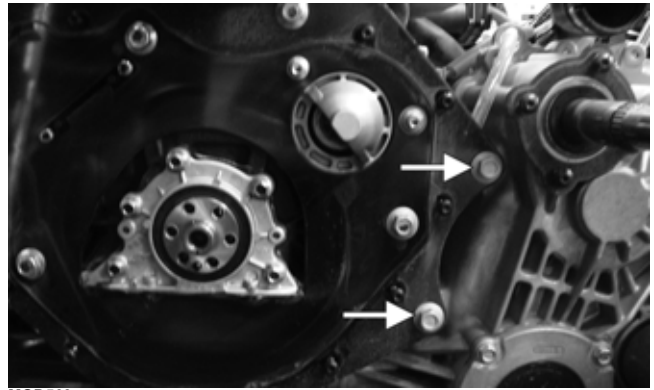

MOD563

7. Connect the electrical connections to the transaxle. Secure with nylon straps.

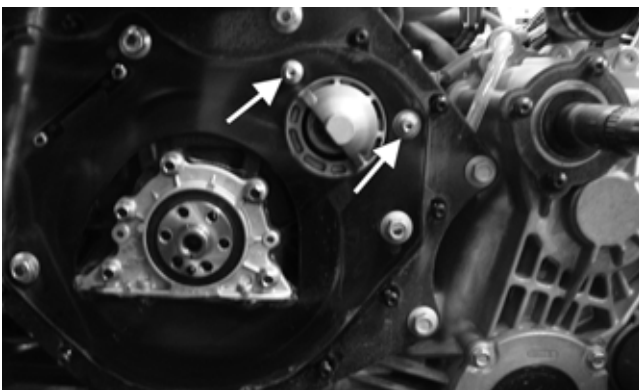

MOD563A

6. Install the spacers for the transaxle to engine mount; then install the two cap screws to secure the transaxle to engine. Tighten to 75 ft-lb (102 N-m).



MOD376

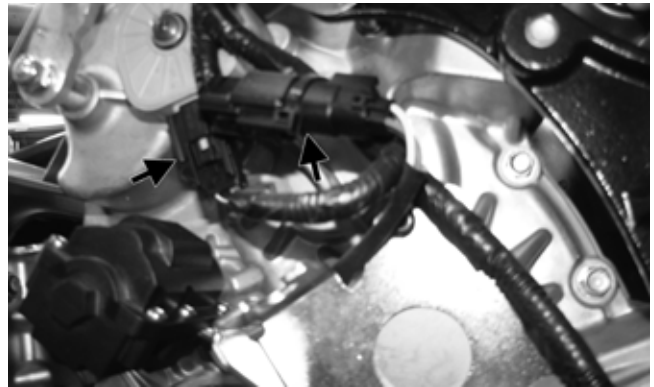

MOD375

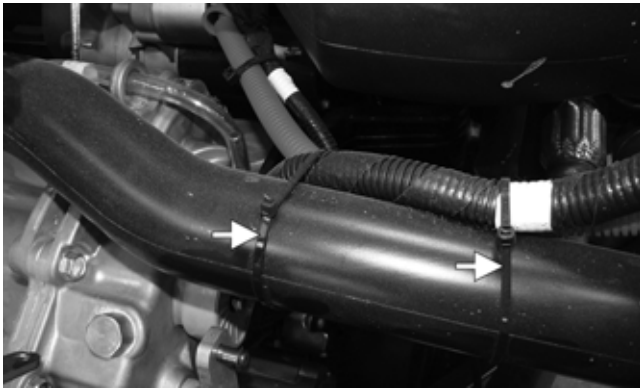

MOD374

8. Connect the shift cable to the transaxle. Then remove the suitable strap that was putting a slight upward tension on the engine.

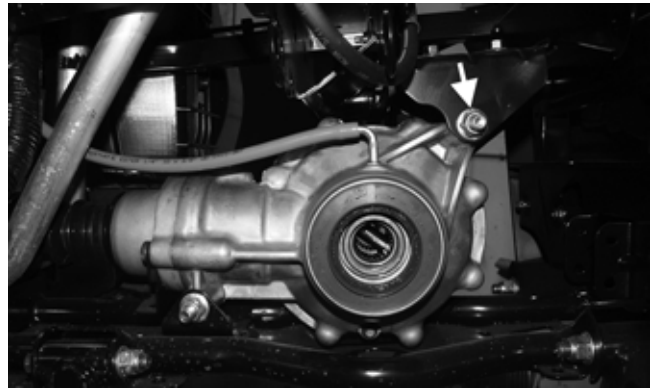

MOD345

11. Install the two cap screws underneath the front differential; then tighten to 16 ft-lb (21.8 N-m); then install the cargo box; then install both rear drive axles; then install both rear inner fenders.



MOD546

9. Install the flywheel, PTO stub shaft, crankshaft position sensor bracket with crankshaft position sensor, and flywheel housing; then install the clutch cover housing, drive clutch, driven clutch, and drive belt.

10. Install the upper differential mount; then install the four cap screws securing the upper differential mount; then tighten to 16 ft-lb (21.8 N-m); then install the upper mount cap screw and new lock nut for the front differential. Tighten to 45 ft-lb (61.2 N-m).



MOD347

Carrier Bearing

The carrier bearing is located beneath the center floor section.

1. Remove the center floor section, and front skid plates.
2. Remove the two cap screws underneath the front differential.

■NOTE: Removal of front axles and wheels are not required.

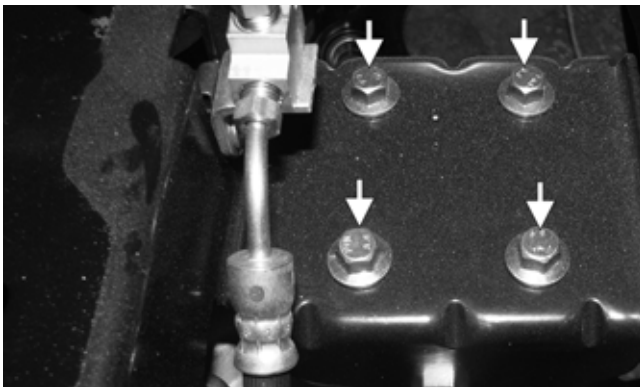

MOD346

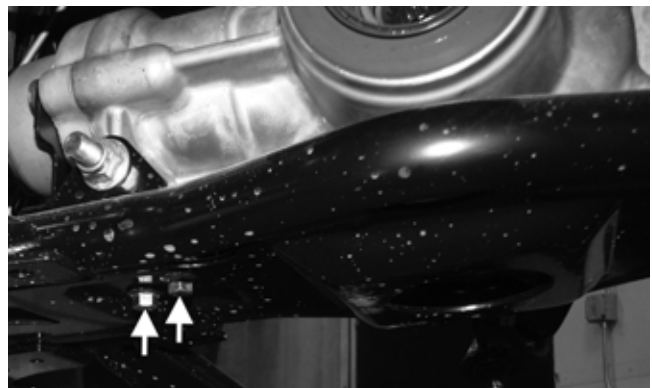

MOD347

3. Remove the upper mount cap screw and lock nut for the front differential; then remove the four cap screws securing the upper differential mount; then remove the upper differential mount.

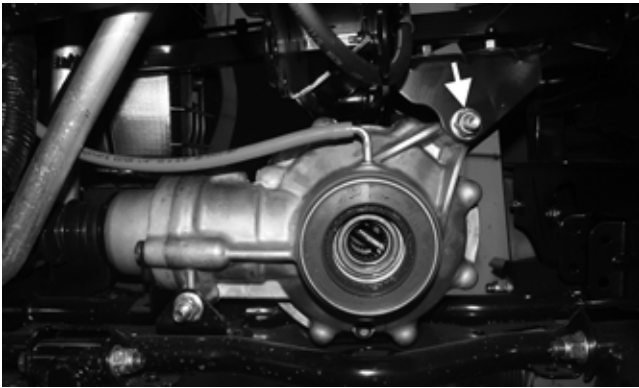

MOD345

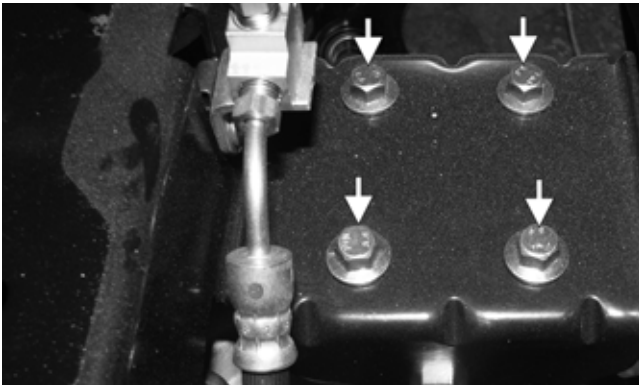

MOD346

4. Remove the two cap screws and lock nuts securing the carrier bearing to the frame.

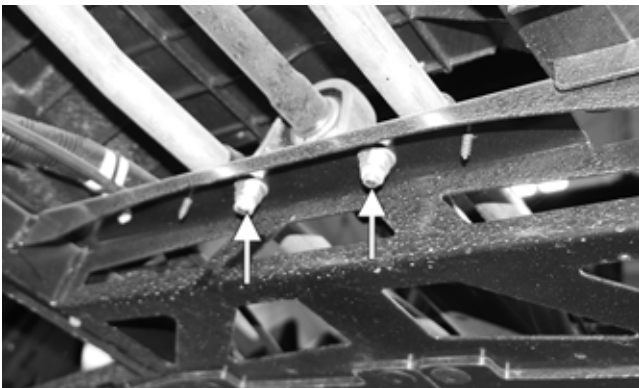

MOD674

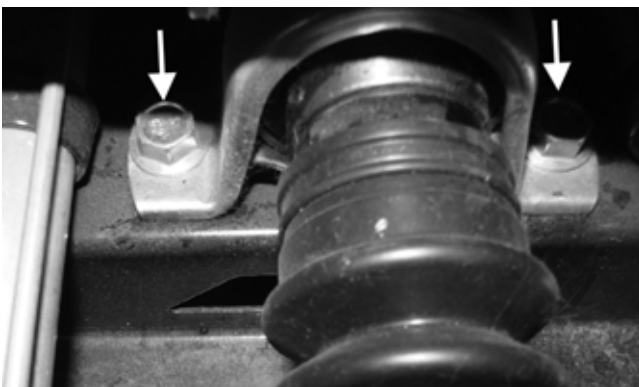

MOD675

5. Gently pull the front driveshaft away from the rear driveshaft and account for the rubber bumper.



MOD676

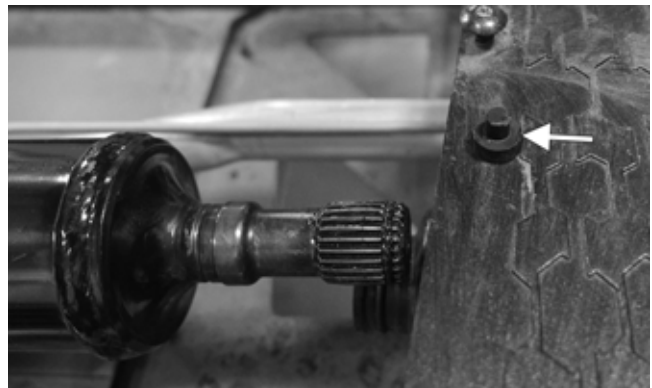

MOD677

6. Gently pull the front driveshaft away from the front differential and account for the rubber bumper; then remove the front driveshaft from the vehicle.

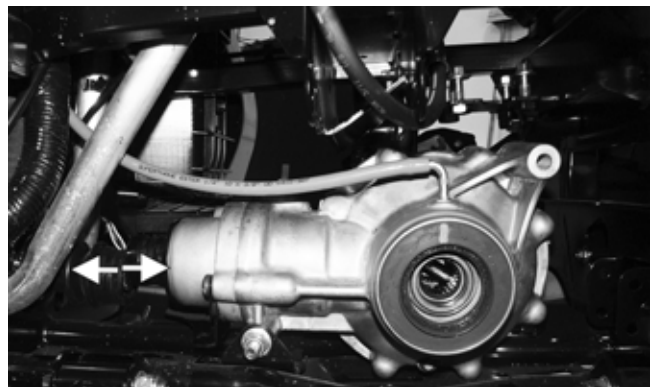

MOD348B



MOD362A

- Remove the snap ring near the carrier bearing; then loosen the two set screws; then remove the carrier bearing.

■NOTE: It may be necessary to lightly tap the carrier bearing with a rubber mallet to aid in removing it.



MOD678



MOD679

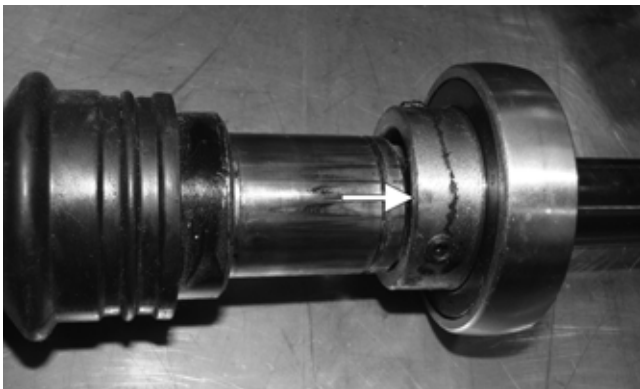

MOD680

INSTALLING

■NOTE: The carrier bearing is intended to be a “slip fit” assembly. It is very important that the surface is free of nicks and rust. It may be necessary to lightly scrub unpainted surfaces with emery cloth to ensure a smooth surface.

■NOTE: Prior to installing the carrier bearing and front driveshaft assembly, verify the spacer is in the front driveshaft. This can be accomplished by looking for machining marks. If the machining marks are visible, the spacer is not there.

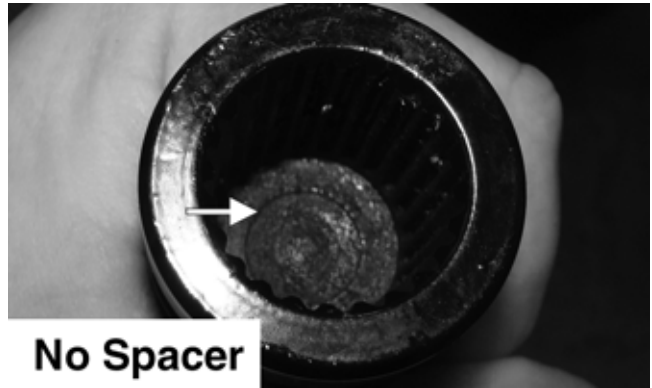

MOD698

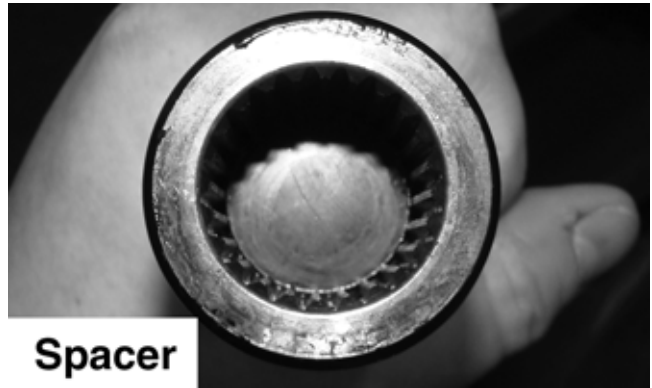

MOD699

- Slide the carrier bearing onto the shaft with the set screw away from the longer end of the driveshaft. Do not tighten the set screws at this time.

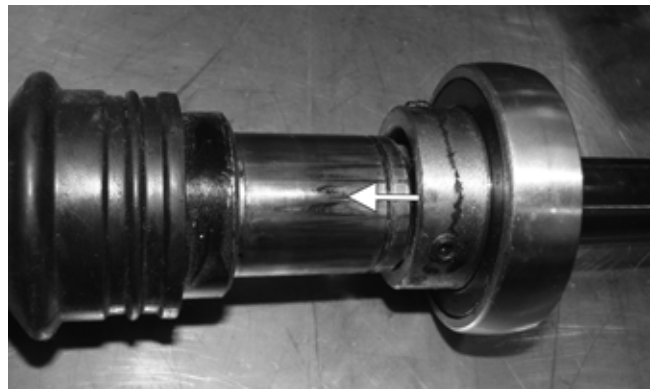

MOD680A

- Install the snap ring, Make sure it is properly seated in the groove.



MOD678

- Remove each set screw and place one drop of red Loctite #271 on each; then install and tighten securely.

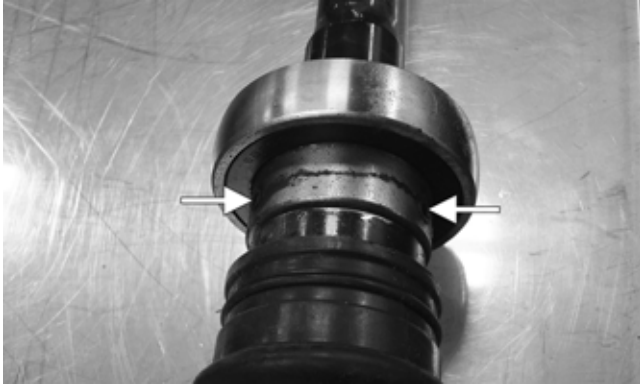

MOD679

- Coat all exposed driveshaft splines with molybdenum grease; then place the driveshaft into position.
- Connect the rear portion of the front driveshaft to the rear driveshaft making sure the rubber bumper is installed correctly.

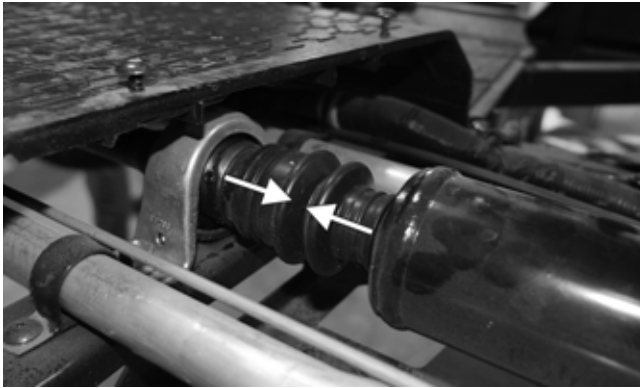

MOD676A

- Install the carrier bearing cap screws and lock nuts; then tighten securely.

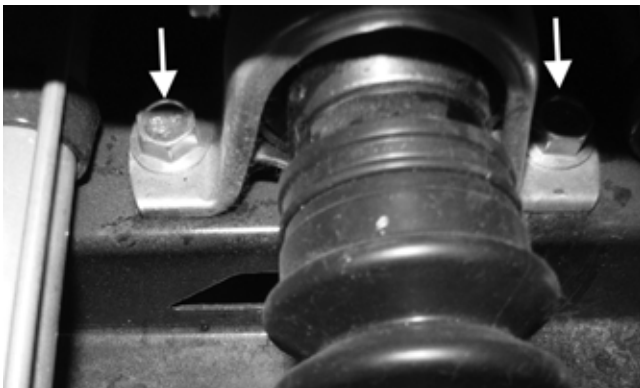

MOD675

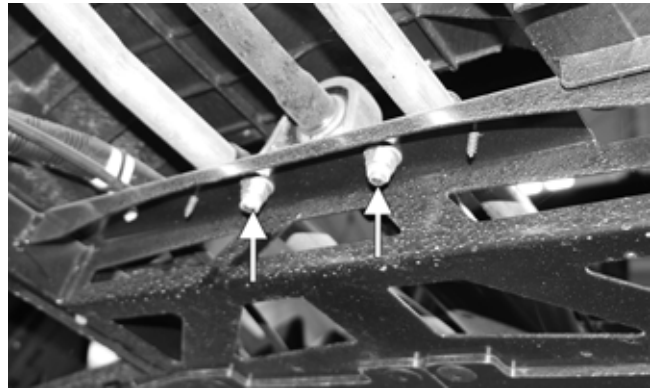

MOD674

- With the rubber boot (A), O-ring (B), and driveshaft bumper (C) set in place, engage the front driveshaft to the differential; then gently slide the front differential toward the rear of the vehicle.



MOD363

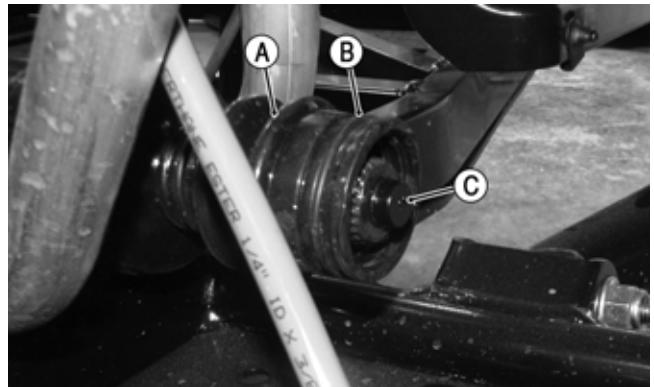

MOD362

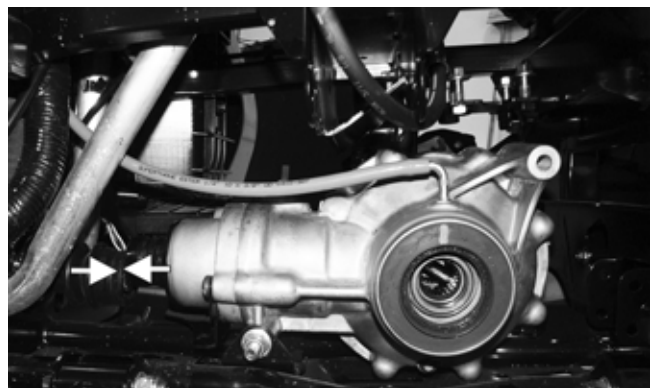

MOD348C

- Install the lower differential mounting cap screws. Do not tighten at this time.



MOD347

9. Install the upper differential mounting bracket and cap screws. Tighten to 16 ft-lb (21.8 N-m).

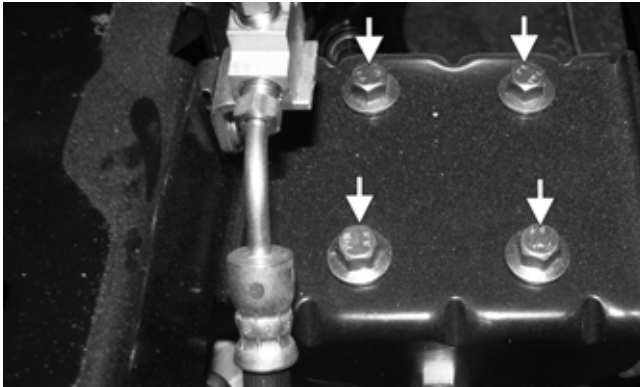

MOD346

10. Install the upper differential mounting cap screw with a new lock nut. Tighten to 45 ft-lb (61.2 N-m); then tighten the lower differential mounting cap screws to 16 ft-lb (21.8 N-m).

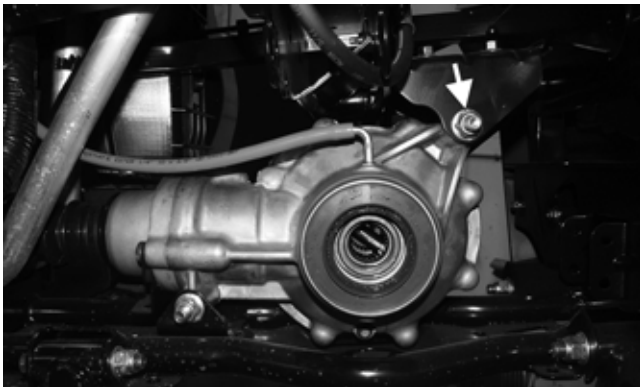

MOD345



MOD347

11. Reinstall the center floor section, and front skid plates.

Hub/Brake Disc

■NOTE: The brake disc is not removable from the hub. If a brake disc needs replacing, a new hub is required.

REMOVING

1. Secure the vehicle on a support stand to elevate the wheel; then remove the wheel(s).

■NOTE: The jack stands should be placed under the main frame to avoid contact with front suspension components.

WARNING

Make sure the vehicle is solidly supported on the support stand to avoid injury.

2. Remove the hub retaining plate from the hub nut.



MOD331

3. Remove the hub nut securing the hub.
4. Remove the brake caliper(s).

■NOTE: It is not necessary to remove the brake hoses from the calipers for this procedure.

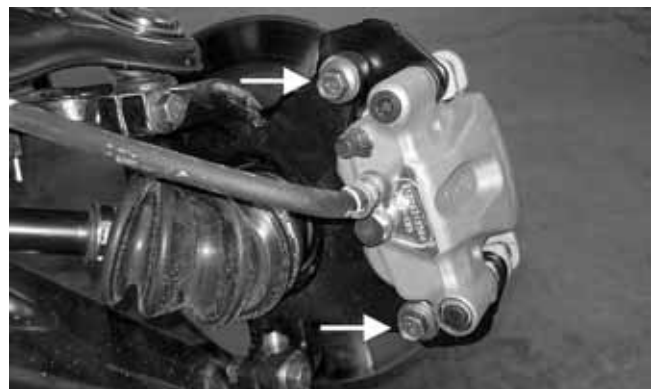

MOD130A

5. Remove the hub assembly.

CLEANING AND INSPECTING

1. Clean all hub components.
2. Inspect all threads for stripping or damage.
3. Inspect the brake disc for cracks or warping.

4. Inspect the hub for pits, cracks, loose studs, or spline wear.

REPLACING WHEEL STUDS

1. Secure the hub in a suitable holding fixture.
2. Drive the damaged stud out of the hub; then place the new stud into the hub and thread on an appropriate nut.

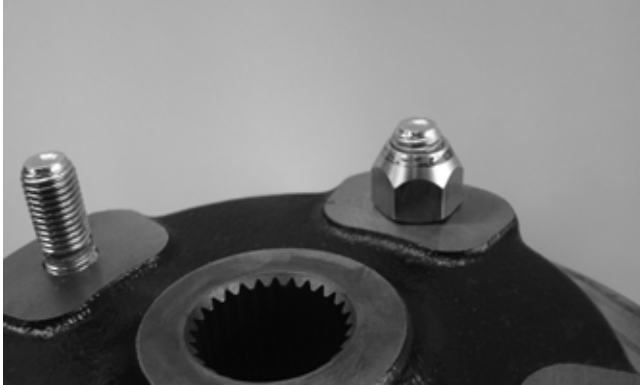

MOD343

3. Using a socket and ratchet handle, tighten the nut until the stud is fully drawn into the hub.

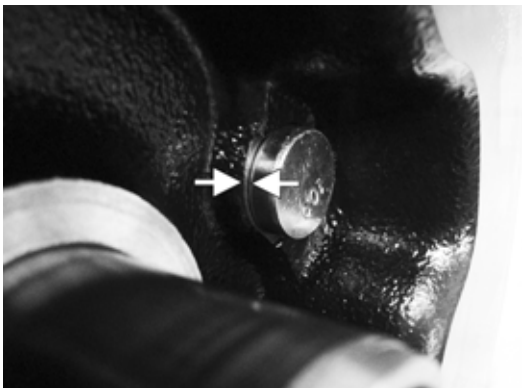

MOD351

INSTALLING

1. Apply grease to the splines in the hub.

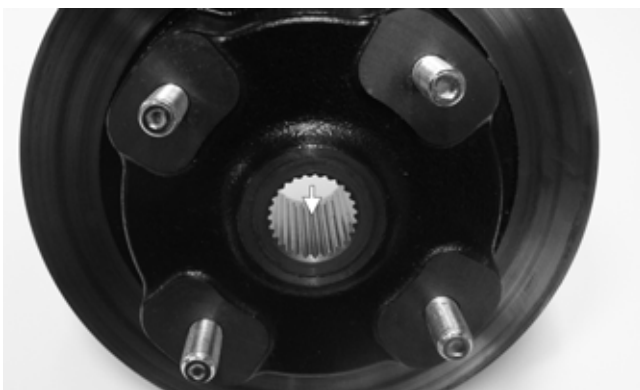

MOD328

2. Install the hub assembly onto the axle.

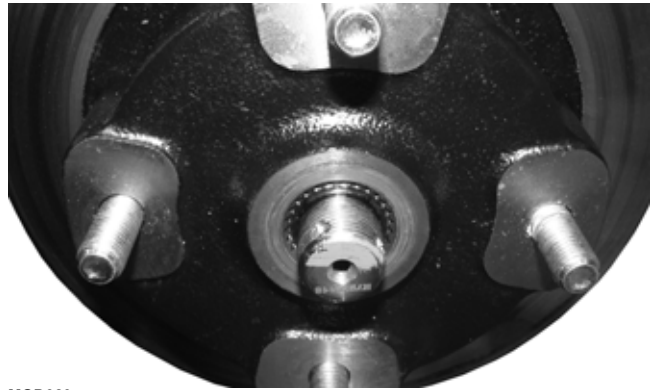

MOD329

3. Secure the hub assembly with the nut. Tighten to 250 ft-lb (339 N-m); then install the hub retaining plate.

■NOTE: If the hub retaining plate cannot be inserted due to misalignment of the hole in the axle and the slots in the nut, tighten the nut until properly aligned. The hub retaining plate must be against the hub with no gap.

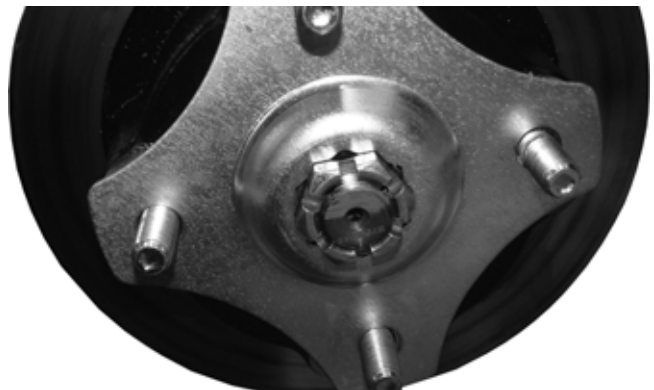

MOD331

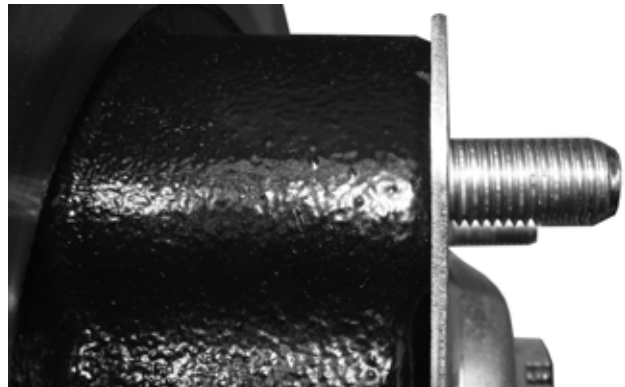

MOD332

4. Secure the brake calipers to the knuckle with two new “patch-lock” cap screws tightened to 45 ft-lb (61.2 N-m).

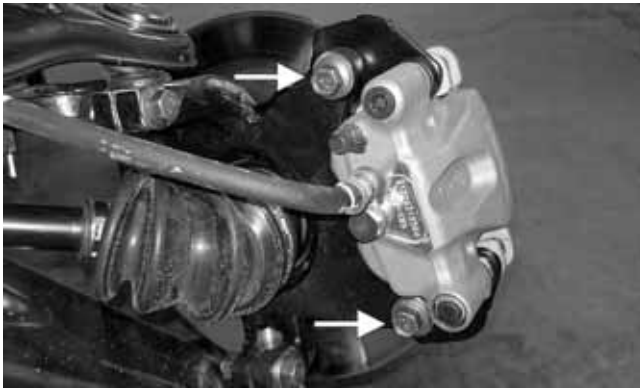

MOD130A

5. Install the wheels and using a crisscross pattern, tighten the wheel nuts in 20 ft-lb (27.2 N-m) increments to a final torque of 100 ft-lb (136 N-m).
6. Remove the vehicle from the support stand.

Hydraulic Brake Caliper

WARNING

Only authorized dealers should perform hydraulic brake service. Failure to properly repair brake systems can result in loss of control causing severe injury or death.

■NOTE: The hydraulic brake calipers are only serviceable as assemblies.

REMOVING

1. Secure the vehicle on a support stand to elevate the wheel; then remove the wheel.

WARNING

Make sure the vehicle is solidly supported on the support stand to avoid injury.

WARNING

Never let brake fluid contact the eyes. Damage to the eyes will occur. Always wear appropriate protective safety goggles and latex gloves when handling brake fluid.

2. Drain the brake fluid from the caliper, hose, and master cylinder through the bleed screw by pumping the brake pedal.



MOD300

CAUTION

Brake fluid is highly corrosive. Do not spill brake fluid on any surface of the vehicle and do not reuse brake fluid.

■NOTE: Whenever brake components are removed, drain all fluid and replace with new DOT 4 brake fluid from an unopened container. Brake fluid readily absorbs moisture from the air significantly lowering the boiling point. This increases the chance of vapor lock reducing braking power and increasing stopping distance.

3. Remove the Torx head plug from the caliper; then remove the caliper.



MOD512

4. Compress the caliper holder against the caliper (opposite the O-ring side) and remove the outer brake pad; then remove the inner brake pad.

■NOTE: If brake pads are to be returned to service, do not allow brake fluid to contaminate them.



MOD302

5. Remove the brake hose from the caliper and close the bleed screw; then remove the caliper mounting bracket from the caliper.

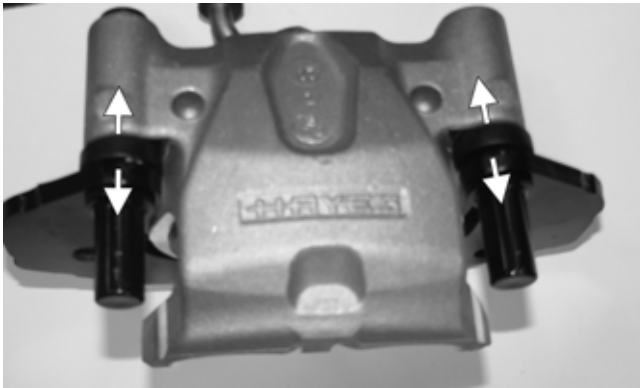

MOD364



MOD365

6. Gently pull the brake caliper boots to remove.



MOD366

CLEANING AND INSPECTING

1. Clean all caliper components (except the brake pads) with DOT 4 brake fluid. Do not wipe dry.
2. Inspect the brake pads for damage and excessive wear.

■NOTE: For measuring brake pads, see Periodic Maintenance/Tune-Up — Hydraulic Brake System.

3. Inspect the brake caliper housings for signs of corrosion or discoloration.
4. Inspect the piston surface for scoring, discoloration, or evidence of binding or galling.
5. Inspect the caliper holder for wear or bending.

ASSEMBLING/INSTALLING

1. Gently install new brake caliper boots into the brake caliper making sure that it is seated completely into the brake caliper housing.



MOD366

2. Apply high temperature silicone grease to the caliper mounting bracket rods; then install the caliper mounting bracket into the caliper.

■NOTE: It is very important to apply silicone grease to the caliper mounting bracket rods prior to assembly.



MOD365

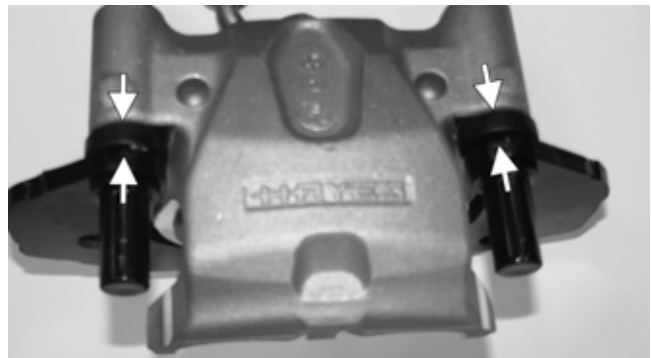

MOD364A

3. Making sure brake fluid does not contact the brake pads, install the inner brake pad; then install the outer pad.

CAUTION

If brake pads become contaminated with brake fluid, they must be thoroughly cleaned with brake cleaning solvent or replaced with new pads. Failure to do so will result in reduced braking and premature brake pad failure.



MOD302

- Place the brake caliper assembly into position and secure with new “patch-lock” cap screws. Tighten the caliper to 45 ft-lb (61.2 N-m).

■**NOTE:** The Torx head plug must be installed in the caliper.

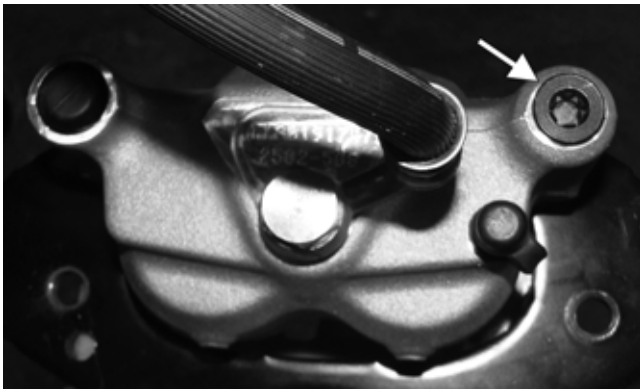

MOD512

- Place a new crush washer on the brake hose fitting and install it on the caliper. Tighten to 20 ft-lb (27.2 N-m).
- Fill the reservoir; then bleed the brake system (see Periodic Maintenance/Tune-Up — Hydraulic Brake System).

⚠ WARNING

Never use brake fluid from an open container or reuse brake fluid. Moisture-contaminated brake fluid could cause vapor build-up (expansion) during hard braking resulting in greatly increased stopping distance or loss of control leading to injury or death.

- Install the wheels and using a crisscross pattern, tighten the wheel nuts in 20 ft-lb (27.2 N-m) increments to a final torque of 100 ft-lb (136 N-m).
- Remove the vehicle from the support stand and verify brake operation.

MASTER CYLINDER ASSEMBLY

■**NOTE:** The master cylinder is only serviceable as an assembly.

Removing

- Slide a piece of flexible tubing over one of the wheel bleeder valves and direct the other end into a container. Remove the reservoir cover; then open the bleeder valve. Allow the brake fluid to drain until the reservoir is empty.



MOD300

- Remove the lower dashboard; then remove the banjo bolt (A) and brake switch (B) securing the banjo-fittings to the master cylinder; then remove the master brake cylinder reservoir clamp and hose (C).

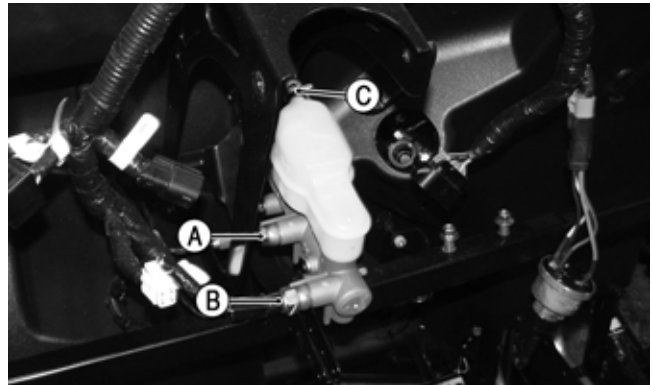

MOD340

- Remove the cotter pin and pivot pin from the yoke; then remove two cap screws securing the master cylinder assembly to the frame.

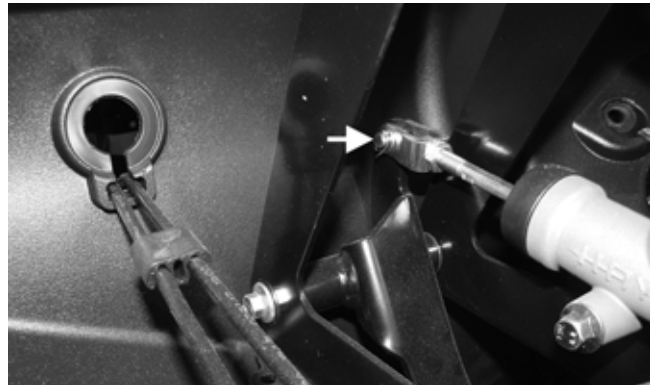

MOD341

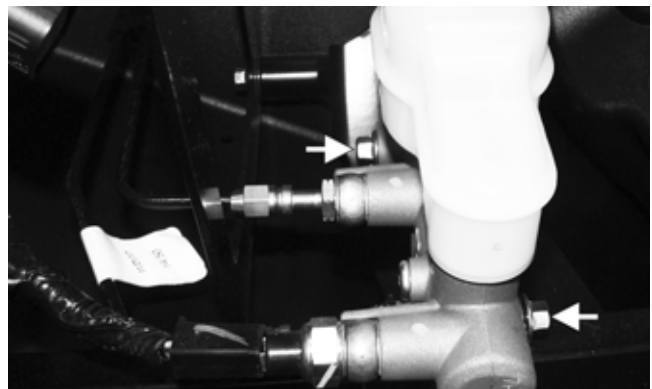

MOD342

4. Remove the master cylinder. Discard the three crush washers.

CAUTION

Brake fluid is highly corrosive. Do not spill brake fluid on any surface of the vehicle.

Inspecting

1. Inspect the master cylinder push rod and clevis for wear, bending, or elongation of clevis holes.
2. Inspect the push rod boot for tears or deterioration.
3. Inspect the reservoir for cracks and leakage.

4. Inspect the brake hose for cracks and deterioration and the condition of the banjo-fittings.

Installing

1. Secure the master cylinder assembly to the frame with two cap screws and two flange nuts. Tighten to 16 ft-lb (21.8 N-m).
2. Using new crush washers, secure the banjo-fittings to the master cylinder with a new banjo bolt and the existing brake switch. Tighten to 20 ft-lb (27.2 N-m).
3. Install the pivot pin and secure with a new cotter pin.
4. Fill the master cylinder and bleed the brake system (see Hydraulic Brake System in the Periodic Maintenance/Tune-Up section).

Troubleshooting Drive System

Problem: Power not transmitted from engine to wheels

| Condition | Remedy |
|----------------------------------------------------------------------------------------------------------------------------------|-------------------------------------------------------------------------------------------------------------------|
| <ol style="list-style-type: none"> 1. Drive belt worn — broken 2. Vehicle shift lever in Park or Neutral | <ol style="list-style-type: none"> 1. Replace drive belt 2. Shift vehicle to desired gear |

Problem: Power not transmitted from engine to either front wheel

| Condition | Remedy |
|-----------------------------------------------------------------------------------------------------------------------------------------------------------------------------------------------------------------------------------------------------------------------------------------------------------------------------------------------------|-----------------------------------------------------------------------------------------------------------------------------------------------------------------------------------------------------------------------------------------------------------------|
| <ol style="list-style-type: none"> 1. Front drive actuator not operating 2. Driveshaft serration worn — broken 3. Coupling damaged 4. Coupling joint serration worn — damaged 5. Front drive — driven bevel gears broken — damaged 6. Front differential gears/pinions broken — damaged | <ol style="list-style-type: none"> 1. Replace fuse — drive select switch — front drive actuator 2. Replace shaft 3. Replace coupling 4. Replace joint 5. Replace gear(s) 6. Replace gears — pinions |

Problem: Gears noisy (Noise seems to come from transaxle)

| Condition | Remedy |
|------------------------------------------------------------------------------------------------------------------------------------------------------------------------------------------------|------------------------------------------------------------------------------------------------------------------------------------------------------------------------------------|
| <ol style="list-style-type: none"> 1. Gears worn — chipped 2. Splines worn 3. Primary gears worn — chipped 4. Bearings worn 5. Bushing worn | <ol style="list-style-type: none"> 1. Replace gears 2. Replace shaft(s) 3. Replace gears 4. Replace bearings 5. Replace bushing |

Troubleshooting Brake System

Problem: Braking poor

| Condition | Remedy |
|----------------------------------------------------------------------------------------------------------------------------------------------------|-----------------------------------------------------------------------------------------------------------------------------------------------------|
| <ol style="list-style-type: none"> 1. Pad worn 2. Brake fluid leaking 3. Master cylinder/brake cylinder seal worn | <ol style="list-style-type: none"> 1. Replace pads 2. Repair — replace hydraulic system 3. Replace master cylinder |

Problem: Brake pedal travel excessive

| Condition | Remedy |
|---------------------------------------------------------------------------------------------------------|------------------------------------------------------------------------------------------------------------------|
| <ol style="list-style-type: none"> 1. Brake fluid low 2. Piston seal — cup worn | <ol style="list-style-type: none"> 1. Add fluid to proper level 2. Replace brake caliper |

Problem: Brake fluid leaking

| Condition | Remedy |
|--------------------------------------------------------------------------------------------------------------------------------------|----------------------------------------------------------------------------------------------------------------------------------|
| <ol style="list-style-type: none"> 1. Connection fittings loose 2. Hose cracked 3. Piston seal worn | <ol style="list-style-type: none"> 1. Tighten fittings 2. Replace hose 3. Replace brake caliper |

Problem: Brake pedal spongy

| Condition | Remedy |
|------------------------------------------------------------------------------------------------------------------|------------------------------------------------------------------------------------------------------------------------------------------|
| <ol style="list-style-type: none"> 1. Air trapped in hydraulic system 2. Brake fluid low | <ol style="list-style-type: none"> 1. Bleed hydraulic system 2. Add brake fluid and bleed hydraulic brake system |

Suspension

The following suspension system components should be inspected periodically to ensure proper operation:

- A. Shock absorber rods bent, pitted, or damaged.
- B. Rubber damper cracked, broken, or missing.
- C. Shock absorber body damaged, punctured, or leaking.
- D. Shock absorber eyelets broken, bent, or cracked.
- E. Shock absorber eyelet bushings worn, deteriorated, cracked, or missing.
- F. Shock absorber spring broken or sagging.
- G. Sway bar mountings tight and bushings secure.

SPECIAL TOOL

A special tool must be available to the technician when performing service procedures in this section. Refer to the current Special Tools Catalog for the appropriate tool description.

■NOTE: When indicated for use, each special tool will be identified by its specific name, as shown in the chart below, and capitalized.

| Description | p/n |
|-----------------------------|----------|
| Shock Spring Spanner Wrench | 3441-139 |

■NOTE: Special tools are available from the Service Department.

Shock Absorbers

Each shock absorber should be visibly checked weekly for excessive fluid leakage (some seal leakage may be observed but it does not indicate the shock is in need of replacement), cracks or breaks in the lower case, or a bent shock rod. If any one of these conditions is detected, replacement is necessary.

■NOTE: When the vehicle is operated in extremely cold weather (-23° C/-10° F or colder), a small amount of leakage may be present. Unless the leakage is excessive, replacement is not necessary.

This vehicle is equipped with adjustable shock assemblies in the front and rear to allow for different driving and loading conditions.

The front shock absorbers have an adjustment sleeve with five preload adjustment positions that can be turned with the spanner wrench to increase or decrease coil spring tension.

■NOTE: The softest setting is shown below:



MOD186

■NOTE: Before attempting to adjust suspension, clean dirt and debris from the sleeve and remove load from the suspension; then use the spanner wrench to adjust the sleeve to the desired position.

To adjust the spring force on these shock absorbers, rotate the preload adjustment sleeve with a suitable spanner wrench until desired spring tension is achieved.

| Position | Spring Force | Setting | Load |
|----------|---------------|---------|-------|
| 1 | ↓ Stronger | Soft | Light |
| 2 | | ↕ | ↕ |
| 3 | | ↕ | ↕ |
| 4 | | ↕ | ↕ |
| 5 | | Stiff | Heavy |

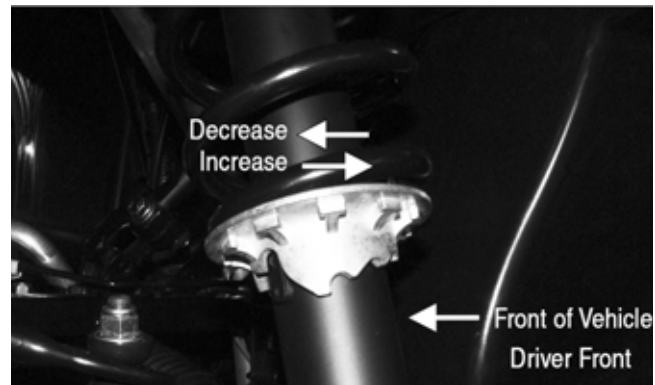

MOD178

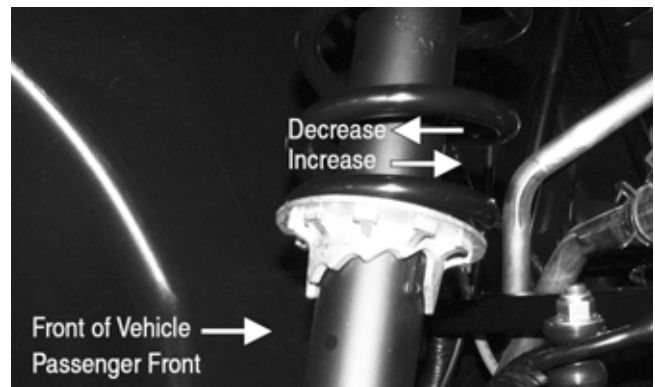

MOD179

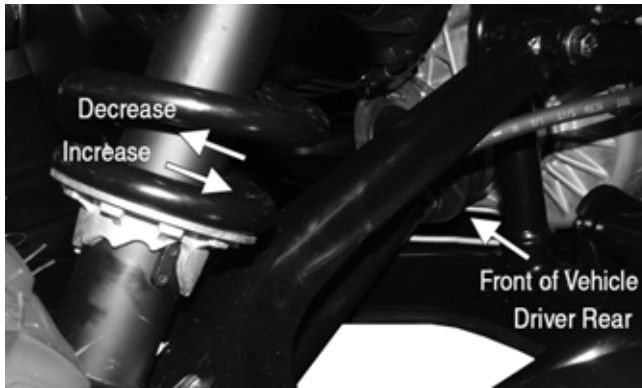

MOD180

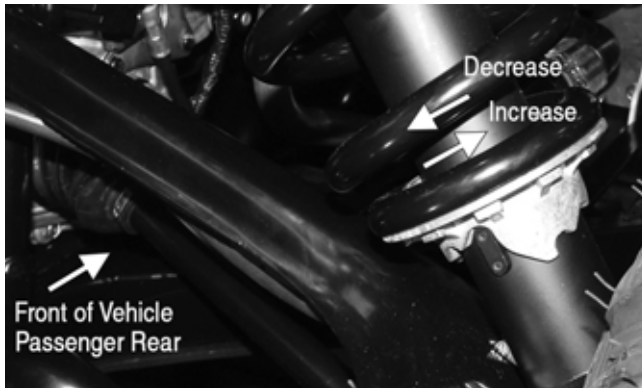

MOD181

REMOVING SHOCK

1. Secure the vehicle on a support stand to elevate the wheels and to release load on the suspension.

⚠ WARNING

Make sure the vehicle is solidly supported on the support stand to avoid injury.

2. Remove the upper and lower mounting cap screws and lock nuts. Discard lock nuts. Inspect cap screws and replace if damaged.

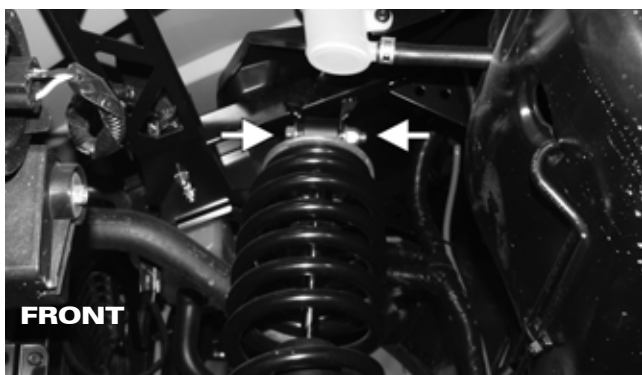

MOD333

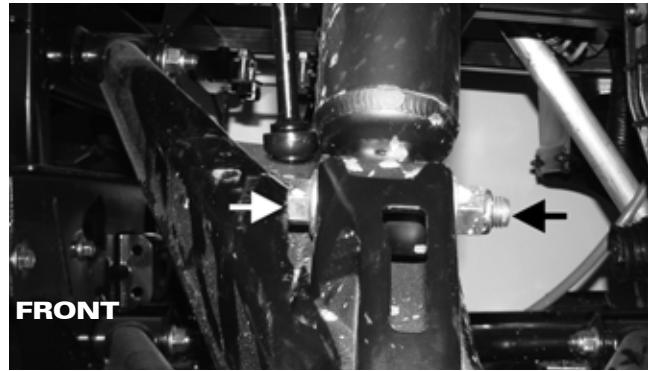

MOD334

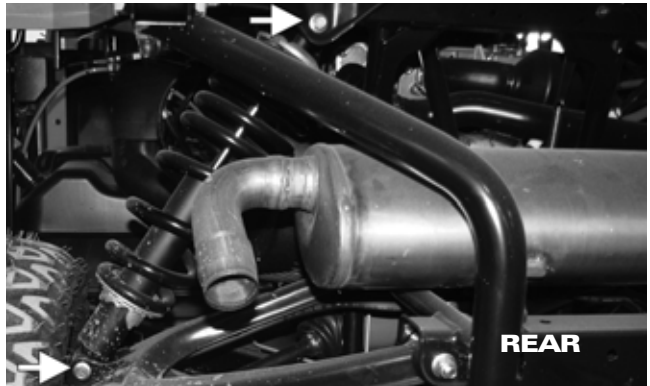

MODC070

REMOVING SPRING

1. Remove the shock; then use a suitable spring compressor, compress the spring and remove the retainer ring.
2. Carefully release the spring pressure and remove the spring. Account for the spring retainer.

⚠ WARNING

Shock absorber springs are under high compression loads. Do not attempt to remove springs without an adequate spring compressor. Severe injury could result.

INSTALLING SPRING

1. Use a suitable spring compressor, compress the spring and install the retainer ring.
2. Carefully release the spring pressure and remove the suitable spring compressor tool.

⚠ WARNING

Shock absorber springs are under high compression loads. Do not attempt to install springs without an adequate spring compressor. Severe injury could result.

CLEANING AND INSPECTING

1. Clean all shock absorber components in parts-cleaning solvent.
2. Inspect each shock rod for nicks, pits, rust, bends, and oily residue.
3. Inspect all springs, spring retainers, shock rods, sleeves, bushings, shock bodies, and eyelets for cracks, leaks, and bends.

INSTALLING

1. Install the shock absorbers with two cap screws and new lock nuts. Tighten to 45 ft-lb (61.2 N-m).
2. Remove the vehicle from the support stand.

Front A-Arms

REMOVING

1. Remove the hubs (see Drive and Brake Systems section).
2. Remove the brake hose clamps from the upper A-arm; then cut the cable tie from the A-arm. Note the location of the white marks on the brake line for installation purposes.

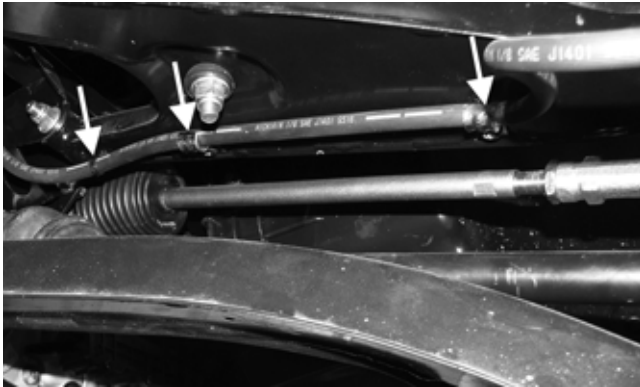

MOD501

3. Remove the cotter pin and castle nut securing the tie rod end to the knuckle; then remove the tie rod end from the knuckle.

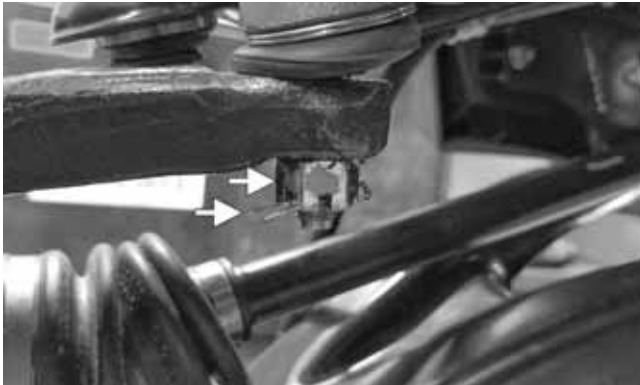

MOD129

4. Remove the cap screws securing the ball joints to the knuckle.

CAUTION

Support the knuckle when removing the cap screws or damage to the threads will occur.



MOD130

5. Tap the ball joints out of the knuckle; then remove the knuckle.
6. Remove the lower shock absorber eyelet from the upper A-arm.

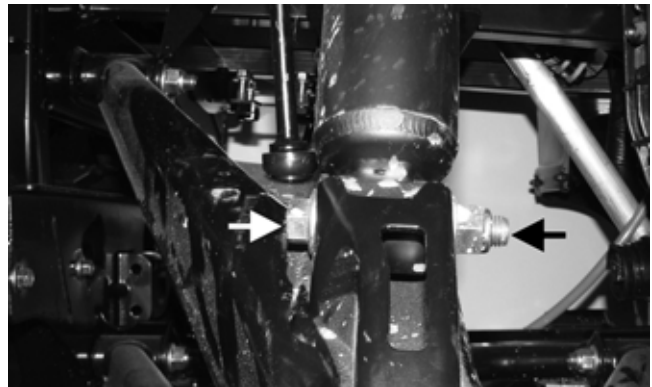

MOD334

■NOTE: When removing the lower A-arm, removal of the front fascia is also required.

7. Remove the cap screws securing the A-arms to the frame.

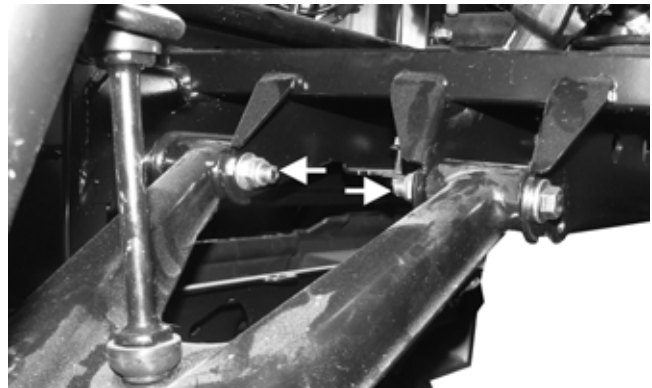

MOD335



MOD336

8. Remove the snap ring from the ball joint; then remove the ball joint from the A-arm.



MOD337

CLEANING AND INSPECTING

1. Clean all A-arm components in parts-cleaning solvent.
2. Clean the ball joint mounting hole of all residual Loctite, grease, oil, or dirt for installing purposes.
3. Inspect the A-arm for bends, cracks, and worn bushings.
4. Inspect the ball joint mounting holes for cracks or damage.
5. Inspect the frame mounts for signs of damage, wear, or weldment damage.

INSTALLING

1. Apply Loctite Primer "T" to the A-arm socket; then apply green Loctite #609 to the entire outside diameter of the ball joint. Install the ball joint into the A-arm and secure with the snap ring.



MOD337

2. Install the A-arm assemblies into the frame mounts and secure with the cap screws. Only finger-tighten at this time.



MOD336

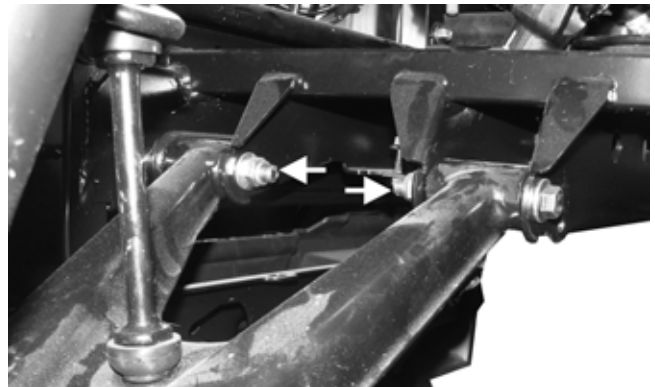

MOD335

3. Route the brake hose along the upper A-arm. Secure with hose anchors and the clamp.

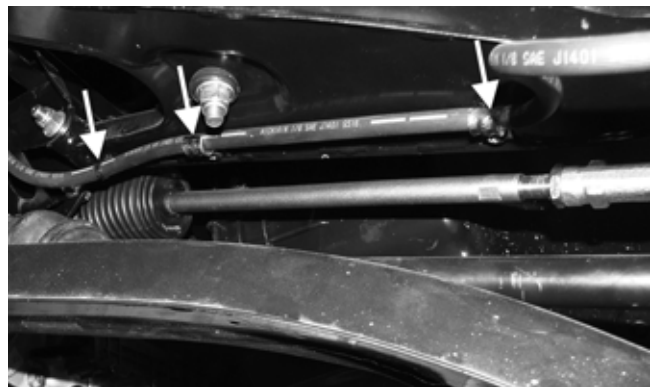

MOD501

4. Secure the lower eyelet of the shock absorber to the lower A-arm. Tighten nut to 45 ft-lb (61.2 N-m).
5. Secure the A-arm assemblies to the frame mounts (from step 2). Tighten the upper A-arm cap screws to 45 ft-lb (61.2 N-m) and the lower A-arm cap screws to 45 ft-lb (61.2 N-m). If removed, install the lower fascia.
6. Install the knuckle assembly onto the ball joints and secure with cap screws. Tighten to 45 ft-lb (61.2 N-m).



MOD130

7. Install the tie rod end and secure with the nut (coated with red Loctite #271). Tighten to 32 ft-lb (43.5 N-m); then install a new cotter pin and spread the pin to secure the nut.

■ **NOTE:** During assembly, new cotter pins should be installed.



MOD129

8. Apply grease to the hub and drive axle splines; then install the hub (see Drive and Brake Systems section).

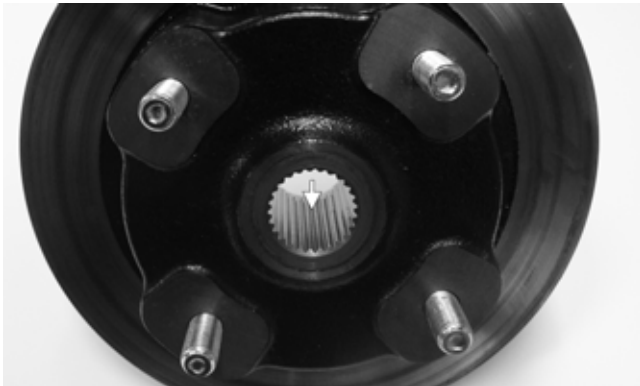

MOD328

9. Secure the brake caliper holder to the knuckle with two new "patch-lock" cap screws. Tighten to 45 ft-lb (61.2 N-m).



MOD130A

10. Install the wheels and using a crisscross pattern, tighten the wheel nuts in 20 ft-lb (27.2 N-m) increments to a final torque of 100 ft-lb (136 N-m).

11. Remove the vehicle from the support stand.

Sway Bar

REMOVING

1. With the vehicle in Park, secure the vehicle on a support stand to elevate the wheels.

WARNING

Make sure the vehicle is solidly supported on the support stand to avoid injury.

2. Using a wrench on the flat spot (A) of the sway bar link, remove at least one sway bar link lock nut (B) per side. Account for the four sway bar link bushings (C). Discard lock nuts.

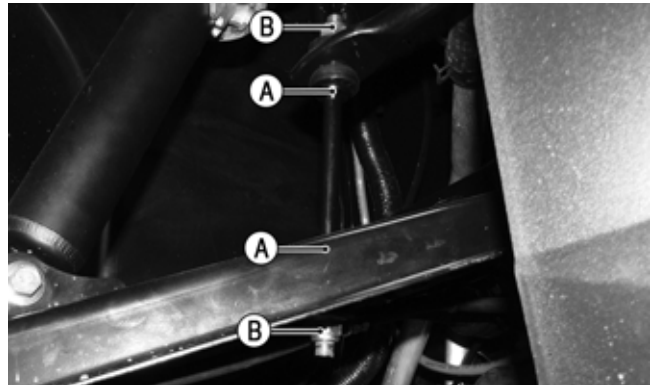

MOD503

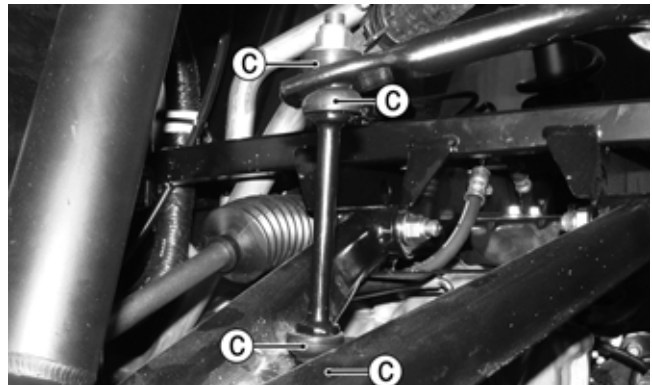

MOD504

3. Remove the two cap screws per side securing the sway bar to the frame; then remove sway bar from frame.



MOD505

INSTALLING

1. Position the sway bar into the vehicle; then push the sway bar mount toward the center of the vehicle and lightly coat with grease on the sway bar where the sway bar mount will be; then position the sway bar mount to the mounting location and install the two cap screws securing the sway bar to the frame. Tighten to 20 ft-lb (27.2 N-m). Repeat for other side.



MOD506

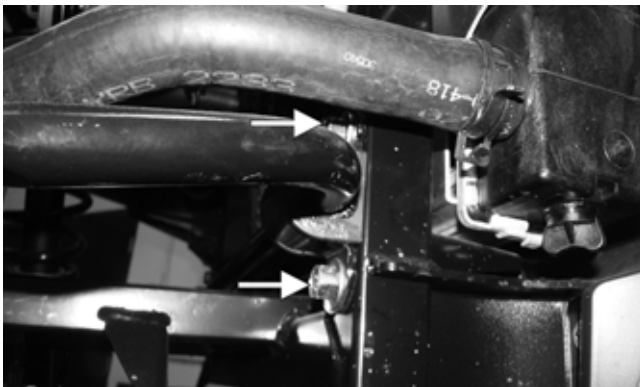

MOD505

2. Position the sway bar link into the upper A-arms with the four bushings as shown; then using a wrench on the flat spot (A) of the sway bar link, install new sway bar link lock nuts (B). Tighten so there are 1-2 threads exposed on the upper sway bar link and 5-6 threads exposed on the lower sway bar link. Repeat for other side.

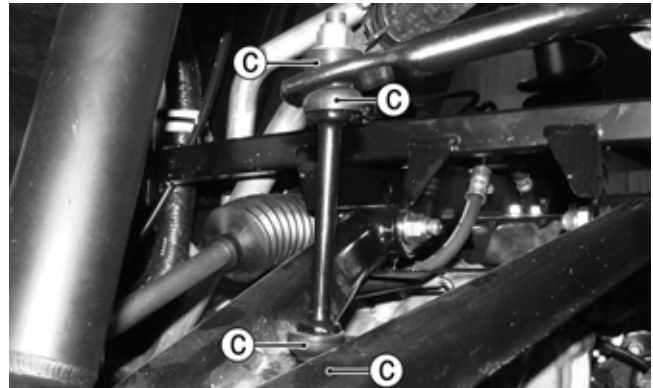

MOD504

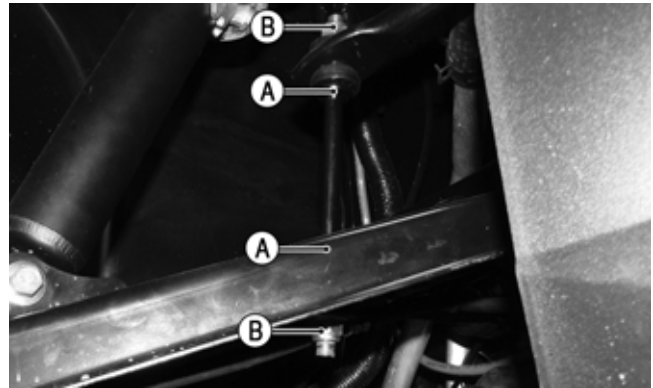

MOD503

3. Remove the vehicle from the secure support stand.

Rear A-Arms

REMOVING

1. With the vehicle in Park, secure the vehicle on a support stand to elevate the wheels.

WARNING

Make sure the vehicle is solidly supported on the support stand to avoid injury.

2. Remove the wheel; then remove the brake caliper; then remove the hub.
3. Remove the lower shock cap screw and lock nut; then secure the shock up and out the way with a suitable strap.
4. Remove the knuckle cap screws and lock nuts; then remove the knuckle; then position the half shaft away from the A-arms.
5. Remove the nylon strap and clamp securing the brake line underneath the upper A-arm; then remove the upper A-arm cap screws and lock nuts; then remove the upper A-arm. Discard lock nuts. Inspect cap screws and replace if damaged.



MOD371

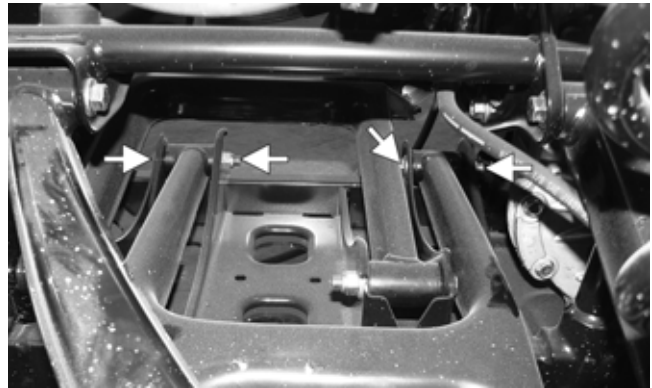

MOD372

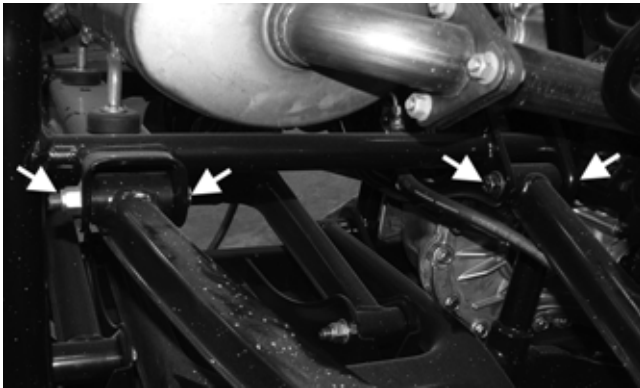

MOD370

■NOTE: When removing a lower A-arm it is required to lift the opposite lower A-arm in order to have access to the cap screws. This is best accomplished by removing the lower shock mount cap screw for the opposite A-arm and using a suitable strap to lift the A-arms.

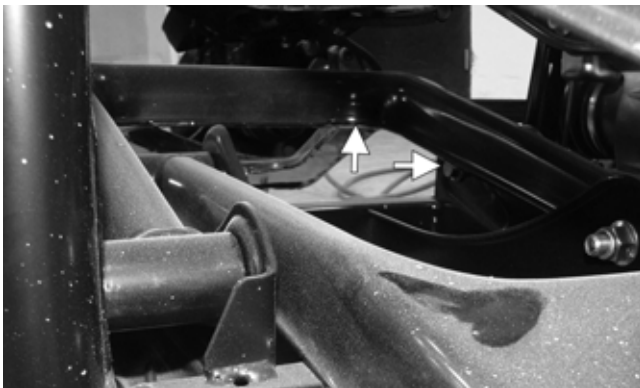

MOD369

6. Remove the lower A-arm cap screws and lock nuts; then remove the lower A-arm. Discard lock nuts. Inspect cap screws and replace if damaged.

CLEANING AND INSPECTING

1. Clean all A-arm components in parts-cleaning solvent.
2. Inspect the A-arm for bends, cracks, and worn bushings.
3. Inspect the frame mounts for signs of damage, wear, or weldment damage.

INSTALLING

1. Install the A-arm assemblies into the frame mounts and secure with the cap screws and new lock nuts. Finger tighten only at this point.

CAUTION

The lower rear A-arm bolts must be installed with the driver-side A-arm (A) cap screw threads toward the rear of the vehicle and the passenger-side A-arm (B) cap screw threads toward the front of the vehicle as shown. Failure to do so will result in suspension component damage.

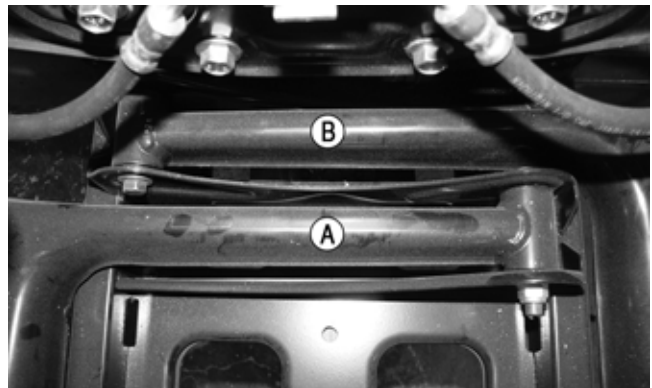

MOD507

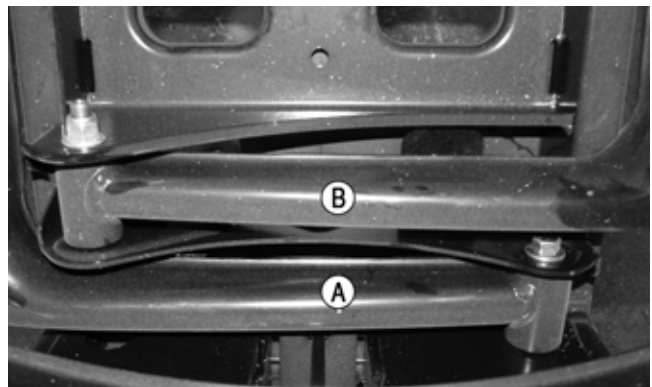

MOD508

- Slide the knuckle onto the drive axle and into position on the A-arms; then secure the knuckle to the A-arms with cap screws and new lock nuts. Tighten to 45 ft-lb (61.2 N-m).
- Tighten the hardware securing the A-arms to the frame mounts (from step 1) to 45 ft-lb (61.2 N-m).
- Secure the lower shock mount to the A-arms with a cap screw and new lock nut. Tighten to 45 ft-lb (61.2 N-m).
- Install the hub; then the brake caliper.
- Install the wheels and using a crisscross pattern, tighten the wheel nuts in 20 ft-lb (27.2 N-m) increments to a final torque of 100 ft-lb (136 N-m).
- Remove the vehicle from the support stand.

Rear Knuckles

CHECK FOR DAMAGED OR WORN BEARING, COLLAR AND BUSHINGS

- Secure the vehicle on a support stand to elevate the wheel.
- Turn wheel right and left to check for free-play.
- If any free-play is present, replace the bearing, bushings and collar as applicable.

REMOVING AND DISASSEMBLING

- With the vehicle in Park, secure the vehicle on a support stand to elevate the wheel.

⚠ WARNING

Make sure the vehicle is solidly supported on the support stand to avoid injury.

- Remove the wheel; then remove the brake caliper; then remove the hub as described in the Hub/Brake Disc section.
- Remove the knuckle cap screws (A) and lock nuts (B); then remove the knuckle. Discard lock nuts (B). Inspect cap screws and replace if damaged.
- If bearing (C) needs to be replaced: Remove the snap ring (D) securing the bearing in the knuckle; then press the bearing out of the knuckle. Discard bearing.
- If bushings (E) need to be replaced: Remove dust seals (F), then push collar (G) out of upper knuckle bushings. Press the upper and lower bushings out of knuckle. Discard bushings and collar.

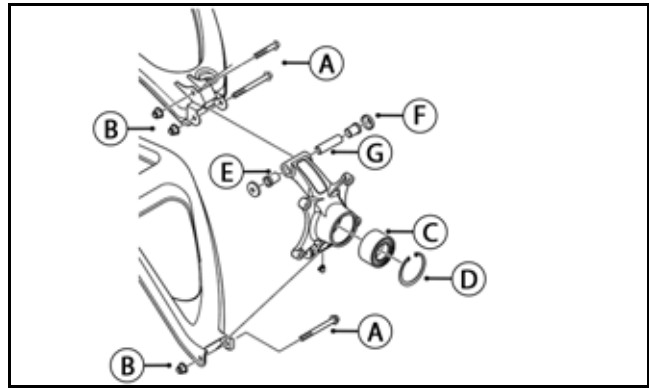

MODC079

CLEANING AND INSPECTING

- Clean all knuckle components.
- Inspect the knuckle for cracks and breaks.
- If replacing bushings and bearings, inspect knuckle for galling of the bearing and bushing surface.

ASSEMBLING AND INSTALLING

- If a bearing needs to be replaced: Using a suitable press and driver, press a new bearing into the knuckle until firmly seated; then install the snap ring with the sharp edge away from the bearing.
- If a bushing needs to be replaced: Using a suitable press and driver, press four new bushings into knuckle until contact is made with bushing flange. Insert new collar and replace dust seal on the upper knuckle bushings.
- Slide the knuckle onto the drive axle and into position on the A-arms; then secure the knuckle to the A-arms with cap screws and new lock nuts. Tighten to 45 ft-lb (61.2 N-m).
- Grease knuckles; clean dirt or debris from the Zerk before adding grease. Add grease to the Zerk until any trapped air or moisture is pushed out.
- Install the hub; then install the brake caliper as described in the Hub/Brake Disc section.
- Install the wheels and using a crisscross pattern, tighten the wheel nuts in 20 ft-lb (27.2 N-m) increments to a final torque of 100 ft-lb (136 N-m).
- Remove the vehicle from the support stand.

Wheels and Tires

TIRE SIZE

 **WARNING**

Use only approved tires when replacing tires. Failure to do so could result in unstable vehicle operation.

This vehicle is equipped with low-pressure tubeless tires of the size and type listed in the General Information section. Do not under any circumstances substitute tires of a different type or size.

 **WARNING**

Always use the size and type of tires specified. Always maintain proper tire inflation pressure.

 **WARNING**

Do not mix tire tread patterns. Use the same pattern type on front and rear. Failure to heed warning could cause poor handling qualities of the vehicle and could cause excessive drive train damage not covered by warranty.

TIRE INFLATION PRESSURE

Front tire inflation pressure should be 82.7 kPa (12 psi) cold. Rear tire inflation pressure should be 97 kPa (14 psi) cold. Rear tire inflation pressure with cargo should be 110 kPa (16 psi) cold.

REMOVING

1. Secure the vehicle on a support stand to elevate the wheels.

 **WARNING**

Make sure the vehicle is solidly supported on the support stand to avoid injury.

2. Remove the nuts securing the wheels; then remove the wheels.

CLEANING AND INSPECTING

1. Clean the wheels and hubs with parts-cleaning solvent.
2. Clean the tires with soap and water.
3. Inspect each wheel for cracks, dents, or bends.
4. Inspect each tire for cuts, wear, missing lugs, and leaks.

INSTALLING

1. Install each wheel on its hub and secure with the existing hardware.
2. Using a crisscross pattern, tighten the wheel nuts in 20 ft-lb (27.2 N-m) increments to a final torque of 100 ft-lb (136 N-m).

CHECKING/INFLATING

1. Using an air pressure gauge, measure the air pressure in each tire. Adjust the air pressure as necessary to meet the recommended inflation pressure.
2. Inspect the tires for damage, wear, or punctures.

 **WARNING**

Do not operate the vehicle if tire damage exists.

■NOTE: If repair is needed, follow the instructions found on the tire repair kit or remove the wheel and have it repaired professionally.

■NOTE: Be sure all tires are the specified size and have identical tread pattern.

Troubleshooting

| Problem: Suspension too soft | |
|---------------------------------------------------------------------------------------------------------------------------------------------------------------------------------------------------------------------------------------------------|------------------------------------------------------------------------------------------------------------------------------------------------------------------------------------------------------------------------------------|
| Condition | Remedy |
| <ol style="list-style-type: none"> 1. Spring preload incorrect 2. Spring(s) weak 3. Shock absorber damaged 4. Shock absorbers too soft | <ol style="list-style-type: none"> 1. Adjust preload 2. Replace spring(s) 3. Replace shock absorber 4. Check/replace shock absorbers |
| Problem: Suspension too stiff | |
| Condition | Remedy |
| <ol style="list-style-type: none"> 1. Spring preload incorrect 2. Shock absorbers too hard | <ol style="list-style-type: none"> 1. Adjust preload 2. Check/replace shock absorbers |
| Problem: Suspension noisy | |
| Condition | Remedy |
| <ol style="list-style-type: none"> 1. Cap screws (suspension system) loose 2. Sway bar bushings worn | <ol style="list-style-type: none"> 1. Tighten cap screws 2. Replace sway bar bushings |
| Problem: Vehicle pulling or steering erratic | |
| Condition | Remedy |
| <ol style="list-style-type: none"> 1. Vehicle steering is erratic on dry, level surface 2. Vehicle pulls left or right on dry, level surface | <ol style="list-style-type: none"> 1. Check front wheel alignment and adjust if necessary (see Steering/Body/Controls — Front Wheel Alignment) 2. Check air pressure in tires and adjust to specifications |
| Problem: Ride height is too low (<10 inches at center of frame to ground) | |
| Condition | Remedy |
| <ol style="list-style-type: none"> 1. Spring(s) weak 2. Spring preload incorrect 3. ROV/UTV overloaded 4. Tires not enough air pressure 5. Spring(s) broken | <ol style="list-style-type: none"> 1. Replace spring(s) 2. Adjust preload 3. Remove weight from ROV/UTV 4. Add the recommended amount of air to tires 5. Replace spring(s) |

NOTES

NOTES

NOTES

TRACKER
OFF ROAD™