

**TRACKER**  
**OFF ROAD™**

# SERVICE MANUAL



p/n: 2262-651  
7/19

**90**

# Table of Contents

<b>General Information/Foreword</b> .....	<b>2</b>	<b>Fuel/Lubrication</b> .....	<b>58</b>
Specifications .....	2	Carburetor .....	58
Torque Specifications .....	3	Throttle Cable Free-Play .....	61
Torque Conversions (ft-lb/N-m) .....	4	Engine RPM (Idle) .....	62
Gasoline — Oil — Lubricant .....	4	Gas Tank.....	62
Preparation for Storage .....	4	Gas Tank Valve.....	63
Preparation after Storage .....	5	Troubleshooting .....	64
<b>Periodic Maintenance/Tune-Up</b> .....	<b>6</b>	<b>Electrical System</b> .....	<b>65</b>
Air Filter .....	6	Battery .....	65
Valve/Tappet Clearance .....	6	Ignition Switch .....	66
Testing Engine Compression.....	8	Ignition Coil .....	66
Spark Plug .....	9	Ignition Timing.....	67
Muffler/Spark Arrester.....	9	Handlebar Control Switches.....	67
Transmission Lubricant.....	10	Brake Light Switches.....	67
Engine Oil .....	10	Headlights .....	68
Brake Systems .....	11	Stator Coil .....	68
Replacing Drive Belt .....	14	Regulator/Rectifier .....	68
Adjusting Shift Linkage .....	15	Timing Sensor .....	68
<b>Steering/Body/Controls</b> .....	<b>16</b>	Starter Motor .....	69
Front Fascia.....	16	Choke Circuit.....	69
Body .....	16	Fuse .....	69
Steering Post/Handlebar/Tie Rods .....	19	Troubleshooting .....	70
Handlebar Grip .....	22	<b>Drive System</b> .....	<b>72</b>
Handlebar Switch .....	22	Drive Chain/Sprockets.....	72
Hand Brake Lever Assemblies .....	23	Rear Hub/Drive Axle.....	74
Headlights.....	25	Front Hub .....	77
Brake Light/Taillight .....	26	Brake Systems .....	78
Troubleshooting .....	27	Troubleshooting Drive System .....	79
<b>Engine/Transmission</b> .....	<b>28</b>	Troubleshooting Brake System .....	79
Removing Engine/Transmission .....	28	<b>Suspension</b> .....	<b>80</b>
Top-Side Components.....	30	Shock Absorbers .....	80
Removing Top-Side Components.....	30	A-Arm .....	81
Servicing Top-Side Components.....	33	Swing Arm .....	83
Installing Top-Side Components.....	37	Wheels and Tires .....	85
Left-Side Components.....	40	Troubleshooting .....	86
Removing Left-Side Components.....	40		
Installing Left-Side Components.....	42		
Right-Side Components .....	43		
Removing Right-Side Components .....	44		
Servicing Right-Side Components.....	47		
Installing Right-Side Components .....	48		
Center Crankcase Components .....	50		
Disassembling Crankcase Halves .....	51		
Servicing Crankcase Components .....	51		
Assembling Crankcase Half.....	52		
Installing Engine/Transmission .....	53		
Troubleshooting .....	56		

## General Information/ Foreword



This Service Manual contains service, maintenance, and troubleshooting information for the 2020 90 model and is designed to aid in service-oriented applications.

This manual is divided into sections. Each section covers a specific ATV component or system and, in addition to the standard service procedures, includes disassembling, inspecting, and assembling instructions. When using this manual as a guide, the technician should use discretion as to how much disassembly is needed to address any given condition.

This service manual is designed primarily for use by a basic level technician. The procedures found in this manual are of varying difficulty, and certain service procedures in this manual require one or more special tools to be completed. The technician should use sound judgment when determining which procedures can be completed based on their skill level and access to appropriate special tools.

■ **NOTE:** Whenever a part is worn excessively, cracked, or damaged in any way, replacement is necessary.

When replacement of parts is necessary, use only genuine ATV parts. They are precision-made to ensure high quality and correct fit. Refer to the appropriate Illustrated Parts Manual for the correct part number, quantity, and description.

ATV publications and decals display the words Warning, Caution, Note, and At This Point to emphasize important information. The symbol  **WARNING** identifies personal safety-related information. Be sure to follow the directive because it deals with the possibility of serious injury or even death. A **CAUTION** identifies unsafe practices which may result in ATV-related damage. Follow the directive because it deals with the possibility of damaging part or parts of the ATV. The symbol ■ **NOTE:** identifies supplementary information worthy of particular attention. The symbol  **AT THIS POINT** directs the technician to certain and specific procedures to promote efficiency and to improve clarity.

At the time of publication, all information, photographs, and illustrations were technically correct. Some photographs used in this manual are used for clarity purposes only and are not designed to depict actual conditions. Because products are constantly refined and improved, no retroactive obligation is incurred. All materials and specifications are subject to change without notice.

## Specifications

■ **NOTE:** Specifications subject to change without notice.

CHASSIS	
Length (Overall)	146.8 cm (57.8 in.)
Height (Overall)	96.2 cm (37.9 in.)
Width (Overall)	87.6 cm (34.5 in.)
Tire Size	(Front) AT20 x 7-8 (Rear) AT19 x 8-8
Tire Inflation Pressure	0.21 kg-cm <sup>2</sup> (3.0 psi)
MISCELLANEOUS	
Engine Displacement	89.9 cc (5.5 cu-in.)
Bore x Stroke	47 x 51.8 mm (1.85 x 1.62 in.)
Spark Plug Type	CR7HSA
Spark Plug Gap	0.6-0.7 mm (0.024-0.028 in.)
Dry Weight (Approx)	120.2 kg (265 lb)
Gas Tank Capacity	5.7 L (1.5 U.S. gal.)
Reserve Capacity	1.3 L (0.34 U.S. gal.)
Transmission Lubricant (Recommended)	SAE 80W-90 Hypoid
Transmission Lubricant Capacity	250 ml (8.4 fl oz)
Engine Oil Capacity	0.8 L (0.84 U.S. qt)
Gasoline (Recommended)	87 Octane Regular Unleaded
Engine Oil (Recommended)	ACX All Weather (Synthetic)
Headlight	12V/15W
Brake Light	12V/21W/15W
FUEL SYSTEM	
Carburetor Type	Keihin PTE
Main Jet	80
Slow Jet	40
Idle Screw Setting (turns out)	2 1/2
Jet Needle	NQL-8
Idle RPM	1800
Throttle Slide	G8C
Float Height	10.2 mm (0.40 in.)
Throttle Cable Free-Play (at lever)	6.0 mm (0.25 in.)
ELECTRICAL SYSTEM	
Ignition Timing	13° BTDC ("F" Mark) @ 1800 RPM
Ignition Type	CDI
Spark Plug Cap	4725-5775 ohms
Ignition Coil Resistance	(primary) Less than 1 ohm (secondary) 2830-3170 ohms
Timing Sensor (resistance)	80-160 ohms
Regulator/Rectifier	12.1-15.2 DC volts @ 3000 RPM
Stator Coil (no load)	13.5-16.5 AC volts @ 3000 RPM
Stator Coil Resistance	Less than 1 ohm
Choke Circuit (voltage)	3.5-4.5 AC volts

ENGINE		
Piston Ring End Gap (Installed)	(top) (2nd) (oil)	0.15-0.30 mm 0.30-0.45 mm 0.20-0.70 mm
Piston Pin Outside Diameter (Min)		12.96 mm
Piston Pin Bore (Max)		13.03 mm
Piston Skirt/Cylinder Clearance (Max)		0.10 mm
Cylinder Head Distortion (Max)		0.05 mm
Cylinder Bore Trueness		50.00-50.05 mm
Connecting Rod (Small End Inside Diameter) (Max)		13.06 mm
Connecting Rod (Small End Deflection) (Max)		0.40 mm
Connecting Rod/Crankshaft Clearance (Side to Side) (Max)		0.05 mm
Crankshaft (Runout) (Max)		0.10 mm
Camshaft Lobe Height (Intake) (Min)		26.33 mm
Camshaft Lobe Height (Exhaust) (Min)		25.65 mm
Rocker Arm to Shaft Clearance (Max)		0.10 mm
Intake Valve Stem to Guide Clearance (Max)		0.06 mm
Exhaust Valve Stem to Guide Clearance (Max)		0.08 mm
Crankshaft Web-to-Web Distance		45.15-45.20 mm
Oil Pump Outer Rotor to Body Clearance (Max)		0.25 mm
Oil Pump Outer to Inner Rotor Clearance (Max)		0.20 mm
Oil Pump Rotor End Clearance (Max)		0.12 mm
V-Belt Width (Min)		16.5 mm
Centrifugal Clutch Housing (Max)		107.5 mm
Centrifugal Clutch Lining Thickness (Min)		1.0 mm
Driven Pulley Spring Free Length (Min)		154.6 mm
Roller Guide Diameter (Min)		15.4 mm
Movable Drive Face Collar (Max)		24.06 mm

## Torque Specifications

Part	Part Bolted to	Torque ft-lb N-m	
<b>EXHAUST COMPONENTS</b>			
Exhaust Pipe	Cylinder Head	7	10
Muffler	Frame	32	43
<b>BRAKE SYSTEM COMPONENTS</b>			
Brake Banjo-Fitting	Caliper	25	34
Brakeline Hose	Master Cylinder	20	27
Rear Brake Caliper	Rear Axle Housing	22	30
<b>ELECTRICAL COMPONENTS</b>			
Stator*	Stator Plate	8	11
<b>STEERING COMPONENTS</b>			
Wheel	Front/Rear Hub	30	41
Front Wheel Hub	Spindle Axle	45	61
Handlebar Cap	Lower Clamp	10	14
Steering Post Outer Bearing Cap	Inner Bearing Clamp	20	27
Steering Post	Frame	51	69
Tie Rod End	Steering Post	20	27
<b>SUSPENSION COMPONENTS</b>			
Front Shock Absorber	Frame/A-Arm	29	39
Rear Shock Absorber	Frame/Swing Arm	29	39
Swing Arm	Frame	50	68
Swing Arm	Rear Axle Housing	29	39
A-Arm	Frame	29	39
Knuckle	A-Arm	29	39
Tie Rod End	Knuckle	25	34
<b>ENGINE COMPONENTS</b>			
Oil Drain Plug	Crankcase	18	24
Spark Plug	Cylinder Head	9	12
Cylinder Head (Nut)	Cylinder	15	20
Crankcase Half*	Crankcase Half	8	11
Flywheel*	Crankshaft	30	41
Camshaft Holder	Cylinder	15	20
Stationary Drive Sheave*	Crankshaft	27.5	37
Centrifugal Clutch Housing*	Driven Pulley/ Centrifugal Clutch	40	54
Oil Pump	Crankcase	7	9
Oil Pump Gear	Oil Pump	7	9
Oil Screen/Filter Cap	Crankcase	10	14
Cam Chain Tensioner	Cylinder	7	9
Transmission Drain Plug	Transmission	18	24
Cylinder Head (Cap Screw)	Crankcase	7	9
Valve Cover	Cylinder Head	7	9
Spline-Lock	Drive Sprocket	8	11
Engine Mount	Engine/Frame	32.5	44
Intake Pipe	Cylinder Head	7	9
<b>DRIVE TRAIN COMPONENTS</b>			
Rear Hub	Rear Axle Shaft	58	79
Rear Axle Nut (Inner/Outer)*	Rear Axle	86	117
V-Belt Cover	Crankcase	7	9
Transmission Case Cover	Transmission	22	30
Rear Sprocket	Sprocket Retainer	20	27

\* w/Red Loctite #271



## Torque Conversions (ft-lb/N-m)

ft-lb	N-m	ft-lb	N-m	ft-lb	N-m	ft-lb	N-m
1	1.4	26	35.4	51	69.4	76	103.4
2	2.7	27	36.7	52	70.7	77	104.7
3	4.1	28	38.1	53	72.1	78	106.1
4	5.4	29	39.4	54	73.4	79	107.4
5	6.8	30	40.8	55	74.8	80	108.8
6	8.2	31	42.2	56	76.2	81	110.2
7	9.5	32	43.5	57	77.5	82	111.5
8	10.9	33	44.9	58	78.9	83	112.9
9	12.2	34	46.2	59	80.2	84	114.2
10	13.6	35	47.6	60	81.6	85	115.6
11	15	36	49	61	83	86	117
12	16.3	37	50.3	62	84.3	87	118.3
13	17.7	38	51.7	63	85.7	88	119.7
14	19	39	53	64	87	89	121
15	20.4	40	54.4	65	88.4	90	122.4
16	21.8	41	55.8	66	89.8	91	123.8
17	23.1	42	57.1	67	91.1	92	125.1
18	24.5	43	58.5	68	92.5	93	126.5
19	25.8	44	59.8	69	93.8	94	127.8
20	27.2	45	61.2	70	95.2	95	129.2
21	28.6	46	62.6	71	96.6	96	130.6
22	29.9	47	63.9	72	97.9	97	131.9
23	31.3	48	65.3	73	99.3	98	133.3
24	32.6	49	66.6	74	100.6	99	134.6
25	34	50	68	75	102	100	136

## Gasoline — Oil — Lubricant

### FILLING GAS TANK

#### **WARNING**

Always fill the gas tank in a well-ventilated area. Never add gasoline to the ATV gas tank near any open flames or with the engine running or hot. **DO NOT SMOKE** while filling the gas tank.

Since gasoline expands as its temperature rises, the gas tank must be filled to its rated capacity only. Expansion room must be maintained in the tank particularly if the tank is filled with cold gasoline and then moved to a warm area.

#### **WARNING**

Do not over-fill or overflow gasoline when filling the gas tank. A fire hazard could materialize. Always allow the engine to cool before filling the gas tank.

Tighten the gas tank cap securely after filling the tank.

### RECOMMENDED GASOLINE

The recommended gasoline to use is 87 minimum octane regular unleaded. In many areas, oxygenates are added to the gasoline. Oxygenated gasolines containing up to 10% ethanol or 5% methanol are acceptable gasolines.

#### **CAUTION**

Do not use white gas. Only approved gasoline additives should be used.

## RECOMMENDED ENGINE OIL

### **CAUTION**

Any oil used in place of the recommended oil could cause serious engine damage. Do not use oils which contain graphite or molybdenum additives. These oils can adversely affect clutch operation. Also, not recommended are racing, vegetable, non-detergent, and castor-based oils.

The recommended oil to use is ACX All Weather synthetic engine oil, which has been specifically formulated for use in this engine. Although ACX All Weather synthetic engine oil is the only oil recommended for use in this engine, use of any API-certified SM 0W-40 oil is acceptable.

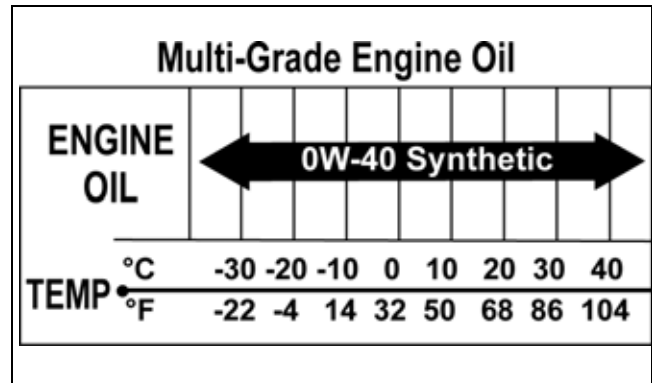

OILCHARTJ

## RECOMMENDED TRANSMISSION LUBRICANT

The recommended lubricant is SAE-approved 80W-90 hypoid. This lubricant meets all the lubrication requirements of the transmission.

### **CAUTION**

Any lubricant used in place of the recommended lubricant could cause serious transmission damage.

## Preparation for Storage

### **CAUTION**

Prior to storing the ATV, it must be properly serviced to prevent rusting and component deterioration.

Use the following procedure to prepare the ATV for storage. An authorized dealer should perform this service; however, the owner/operator may perform this service if desired.

1. Clean the seat cushion (cover and base) with a damp cloth and allow to dry.
2. Clean the ATV thoroughly by washing dirt, oil, grass, and other foreign matter from the entire ATV. Allow the ATV to dry thoroughly. **DO NOT** get water into any part of the engine or air intake.
3. Either drain the gas tank or add a fuel stabilizer to the gas in the gas tank.
4. Clean the interior of the air filter housing.

5. Drain the carburetor float chamber.
6. Plug the hole in the exhaust system with a clean cloth.
7. Apply light oil to the upper steering post bushing and plungers of the shock absorbers.
8. Tighten all nuts, bolts, cap screws, and screws. Make sure rivets holding components together are tight. Replace all loose rivets. Care must be taken that all calibrated nuts, cap screws, and bolts are tightened to specifications.
9. Clean the ATV thoroughly.
10. Disconnect the battery cables (negative cable first); then remove the battery, clean the battery posts and cables, and store in a clean, dry area.

■**NOTE: For storage, use a battery maintainer or make sure the battery is fully charged (see Battery section in this manual).**

11. Store the ATV indoors in a level position.

### **CAUTION**

**Avoid storing outside in direct sunlight and avoid using a plastic cover as moisture will collect on the ATV causing rusting.**

---

---

## **Preparation after Storage**

---

Taking the ATV out of storage and correctly preparing it will ensure many miles and hours of trouble-free riding. Use the following procedure to prepare the ATV:

1. Clean the ATV thoroughly.
2. Clean the engine. Remove the cloth from the exhaust system.
3. Check all control wires and cables for signs of wear or fraying. Replace if necessary.
4. Change the transmission lubricant.
5. Charge the battery; then install.
6. Connect the battery cables making sure to connect the positive cable first.
7. Check the entire brake system (cables, shoes, etc.), all controls, and brake light; adjust or replace if necessary.
8. Check the tire pressure. Inflate to recommended pressure as necessary.
9. Tighten all nuts, bolts, cap screws, and screws making sure all calibrated nuts, cap screws, and bolts are tightened to specifications.
10. Make sure the steering moves freely and does not bind.
11. Check the spark plug. Clean or replace as necessary.
12. Check the air filter and the air filter housing. Clean or replace as necessary.

---

---

## Periodic Maintenance/ Tune-Up

---

Tighten all nuts, bolts, and cap screws. Make sure rivets holding components together are tight. Replace all loose rivets. Care must be taken that all calibrated nuts, bolts, and cap screws are tightened to specifications.

It is advisable to lubricate certain components periodically to ensure free movement. Apply light oil to the components using the following list as reference:

- A. Throttle Lever Pivot/Cable Ends
- B. Brake Lever Pivot/Cable Ends
- C. Idle RPM Adjustment Screw

---

---

## Air Filter

---

The air filter inside the air filter housing must be kept clean to provide good engine power and gas mileage. If the ATV is used under normal conditions, service the filter at the intervals specified. If operated in dusty, wet, or muddy conditions, inspect and service the filter more frequently. Use the following procedure to remove the filter and inspect and/or clean it.

### CAUTION

Failure to inspect the air filter frequently if the ATV is used in dusty, wet, or muddy conditions can damage the engine.

1. Remove the seat and disconnect the breather hose; then remove the five screws securing the air filter housing cover.

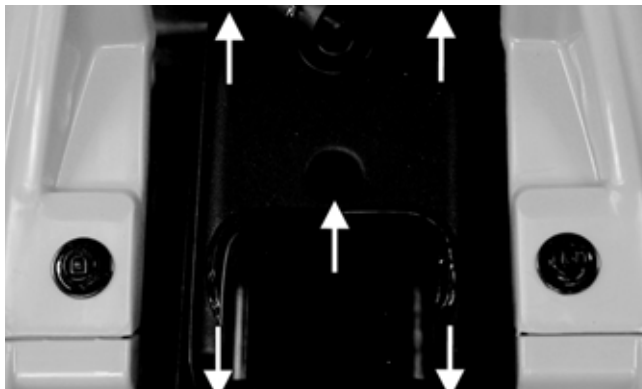

KM032A

2. Remove the air filter housing cover; then pull the filter out.
3. Place the element in a pan larger than the element and spray all sides generously with cleaning solvent, let sit approximately three minutes.
4. In a pan larger than the element, with a mild detergent (dish soap) and water, wash all the dirt and oil off by squeezing the element not twisting it.

■NOTE: Foam Aerosol Filter Cleaner and Foam Aerosol Filter Oil are available.

5. Rinse off any remaining soap.
6. Remove any excess water from the element by matting with a towel.
7. Allow the element to dry completely.
8. Spray oil generously onto air filter and work the oil into the element.
9. Squeeze the element to remove excess oil.

### CAUTION

A torn air filter can cause damage to the ATV engine. Dirt and dust may get inside the engine if the filter is torn. Carefully examine the filter for tears before and after cleaning it. Replace the filter with a new one if it is torn.

10. Clean any dirt or debris from inside the filter housing.
11. Inspect the drain cap beneath the main housing for debris and for proper sealing.
12. Install the air filter and secure with the clamp; then install the air filter housing cover and secure with the screws.
13. Connect the breather hose; then install the seat.

---

---

## Valve/Tappet Clearance

---

To check and adjust valve/tappet clearance, use the following procedure.

■NOTE: Valve/tappet clearance specifications are for room temperature (approximately 68° F).

1. Remove right footwell.
2. Remove the two cap screws and the two self-tapping screws securing the fan shroud; then remove the fan shroud.



CD651

3. Remove the cap screws securing the AIS reed valve and reed valve cover to the valve cover. Note the different length cap screws and orientation of the reed valve as shown.



YT257



CD654



YT258

4. Remove the two chrome-plated cap screws securing the fresh air pipe to the cylinder head. Account for the gaskets at each end.

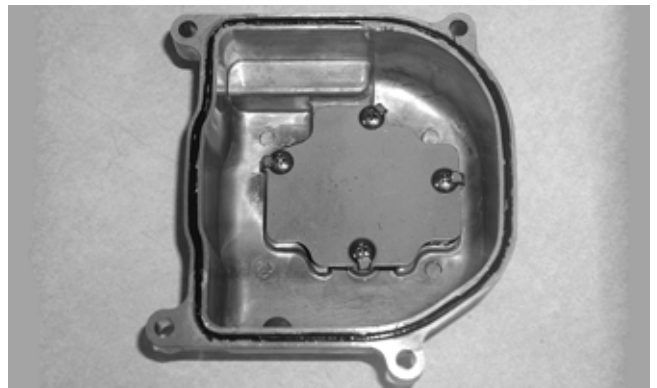

CD655

6. Remove the spark plug wire and the spark plug; then rotate the engine clockwise to the TDC position on the compression stroke.

■NOTE: The “T” mark on the rotor/flywheel is aligned with the timing pointer on the crankcase, and intake and exhaust valve adjuster screws must not have pressure on them. The two punch marks on the camshaft gear are aligned with the valve cover surface, and the hole in the timing gear points away from the engine.



YT259



CD651

5. Remove the breather tube from the valve cover; then remove the four cap screws and remove the valve cover. Account for the O-ring seal and the valve cover.

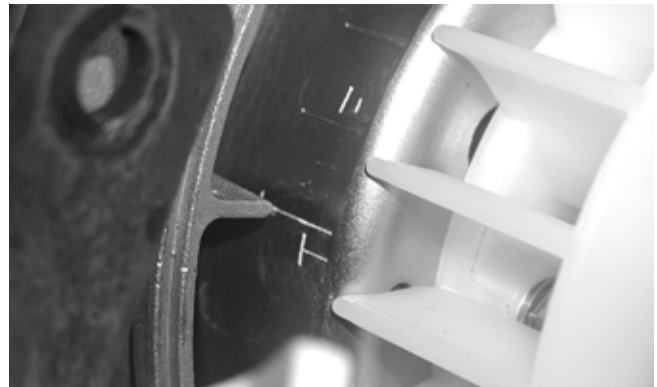

CD652



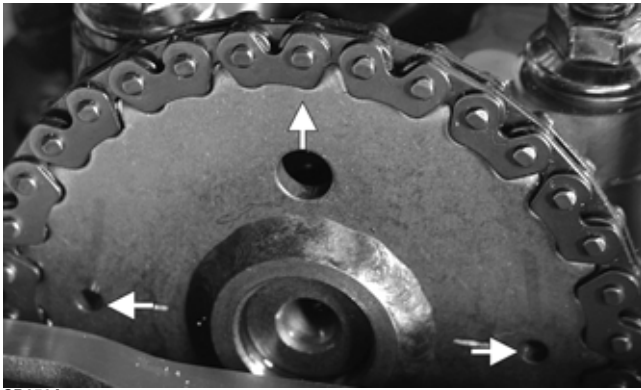

CD656A

7. Using a feeler gauge, check each valve tappet clearance. If the clearance is not between 0.08-0.12 mm, loosen the jam nut and rotate the tappet adjuster screw until the clearance is within specifications. Tighten each jam nut securely after completing the adjustment.



CD659



YT170

8. Check the valve/tappet clearance after the jam nut has been tightened to ensure the clearance did not change.

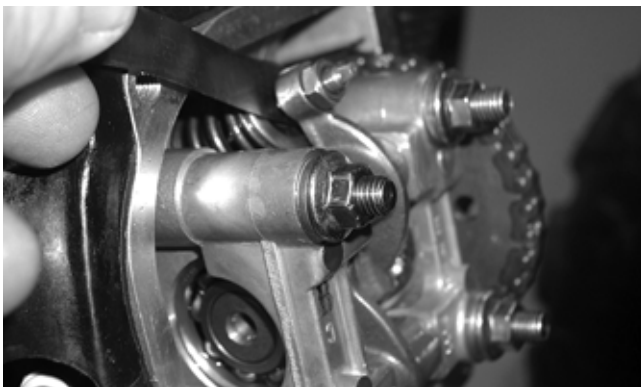

CD658

9. Install the valve cover and tighten the four cap screws to 7 ft-lb using a crisscross pattern; then install the breather tube.
10. With new gaskets in place on each end of the AIS fresh air pipe, set the AIS fresh air pipe into position. Loosely thread the chrome-plated nuts to the cylinder head.



YT259

11. Place the AIS reed valve and reed valve cover onto the valve cover; then secure with the three cap screws. Tighten nuts (from step 10) to 84 in.-lb.



YT257

12. Install the fan shroud and tighten the two cap screws securely. Tighten the self-tapping screws snug taking care not to strip the plastic cover.
13. Install the spark plug and tighten to 9 ft-lb; then install the spark plug wire.

---



---

## Testing Engine Compression

---

1. Remove the high tension lead from the spark plug.
2. Using compressed air, blow any debris from around the spark plug.

**⚠ WARNING**

**Always wear safety glasses when using compressed air.**

3. Remove the spark plug; then attach the high tension lead to the plug and ground the plug on the cylinder head well away from the spark plug hole.
4. Attach the compression tester.

■NOTE: The engine must be warm and the battery must be fully charged for this test.

5. While holding the throttle lever in the full-open position, crank the engine over with the electric starter until the gauge shows a peak reading (five to 10 compression strokes).

■NOTE: Compression should be within a range of 195-230 psi in the full-open throttle position.

6. If compression is abnormally low, inspect the following items:
  - A. Verify starter cranks engine over.
  - B. Gauge is functioning properly.
  - C. Throttle lever in the full-open position.
7. Pour 29.5 ml (1 fl oz) of oil into the spark plug hole, reattach the gauge, and retest compression.
8. If compression is now evident, service the top end (see Engine/Transmission — Servicing Top-Side Components).

---

---

## Spark Plug

---

A light brown insulator indicates the plug and air/fuel ratio are correct. A white or dark insulator indicates that the engine may need to be serviced or the carburetor may need to be adjusted. To maintain a hot, strong spark, keep the plug free of carbon.

### CAUTION

Before removing the spark plug, be sure to clean the area around the spark plug. Dirt could enter engine when removing or installing the spark plug.

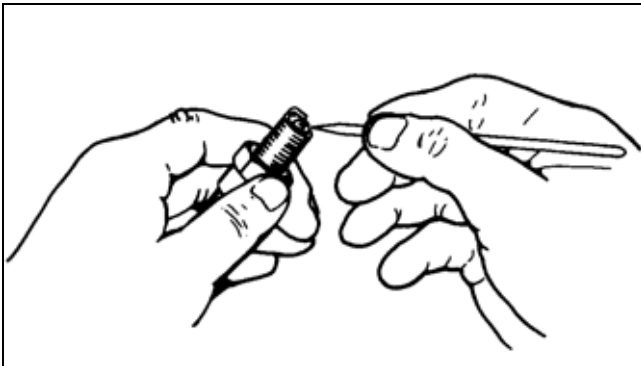

ATV-0051

Adjust the gap to 0.6-0.7 mm (0.024-0.028 in.) for proper ignition. Use a feeler gauge to check the gap.

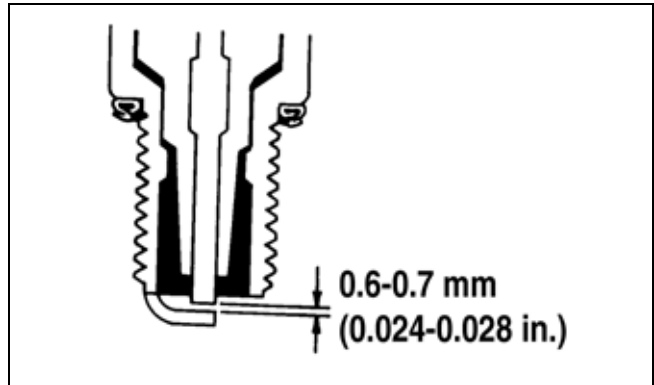

ATV-0052A

A new spark plug should be tightened 1/2 turn once the washer contacts the cylinder head. A used spark plug should be tightened 1/8-1/4 turn once the washer contacts the cylinder head.

---

---

## Muffler/Spark Arrester

---

To clean the arrester, use the following procedure.

### WARNING

Before removing the muffler/spark arrester, wait for it to cool to avoid burns.

1. Remove the cap screw (1) securing the spark arrester assembly (2) to the rear of the muffler. Account for a gasket.



KM139A

2. Clean the screen (3) with a brush and parts-cleaning solvent. Dry with compressed air. If the screen has any holes or tears, it must be replaced.

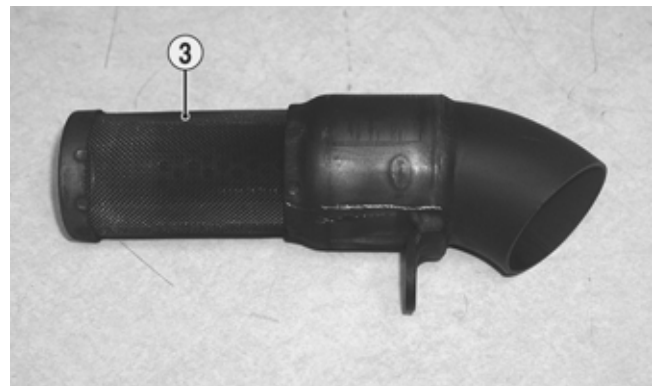

KM140B

**⚠ WARNING**

Before installing the spark arrester, wait for the muffler to cool to avoid burns.

3. Install the spark arrester in the muffler and secure with the cap screw. Tighten securely.



KM139

## Transmission Lubricant

1. Park the ATV on level ground.
2. Remove the level plug from the lower-right side of the transmission; then remove the fill plug from the upper-right side of the transmission. Be careful not to allow contaminants to enter the opening.

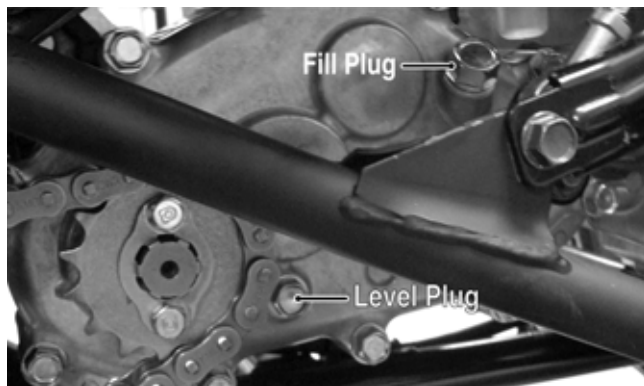

YT188A

3. Remove the drain plug from the bottom of the transmission and drain the lubricant into a drain pan.

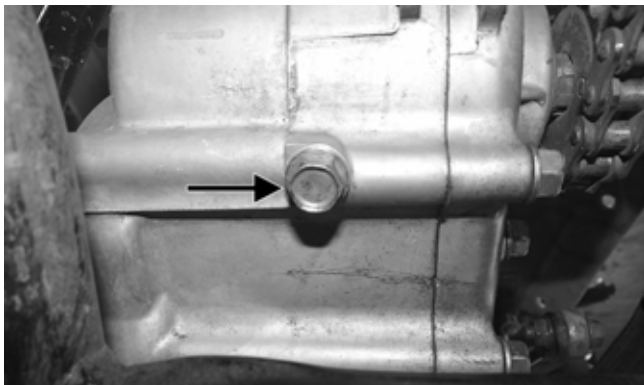

YT215A

4. Install the drain plug and tighten to 18 ft-lb. Pour the recommended lubricant in the fill hole while observing the oil level hole. Stop pouring if oil is observed at the threads of the oil level hole. Install and tighten the oil level plug.
5. Start the engine (while the ATV is outside on level ground) and drive it a short distance.
6. Turn the engine off and wait approximately one minute. Remove the level plug and recheck the lubricant level. The level should be visible at the level hole. If lubricant is not visible, add recommended lubricant until the level is visible at the level hole.
7. Inspect the area around the drain plug for leaks.

## Engine Oil

1. Move the ATV outdoors and start and warm up the engine. Shut the engine off; then place a drain pan under the engine oil drain plug located on the left-side of the engine under the kick starter.



CD634A

2. Remove the oil drain plug and drain the engine oil into the pan; then install the oil drain plug and tighten to 18 ft-lb.

**⚠ WARNING**

Use extreme caution when removing the oil drain plug. Hot oil can cause severe injury and skin burns.

3. Move the drain pan to the right-front of the engine and remove the oil screen/filter cap. Account for a screen, spring, and O-ring. Discard the O-ring.

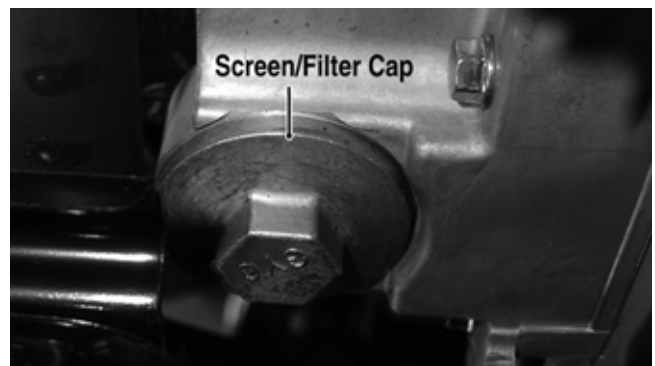

KM040A





CD628

4. Clean the oil screen in parts-cleaning solvent using a brush; then install the screen, spring, and cap making sure the new O-ring is seated properly in the cap. Tighten to 10 ft-lb.



CD626

5. Remove the oil level stick and pour the recommended amount and viscosity oil into the engine; then install the oil level stick.

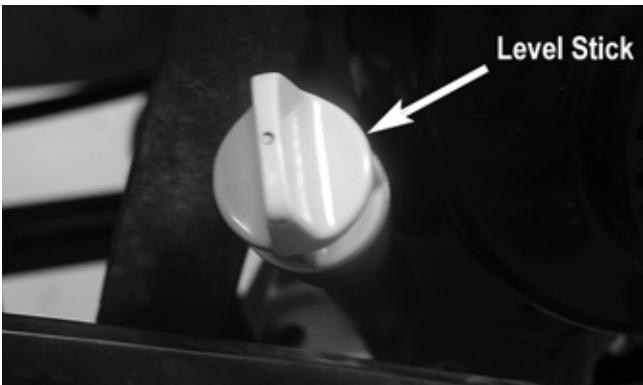

CD629B

6. Start and warm up the engine.
7. Shut the engine off and allow to stand for 2-3 minutes.
8. Remove the oil level stick and wipe with a clean cloth.
9. Install the oil level completely into the engine.
10. Remove the oil level stick; the engine oil level should be at the appropriate level.

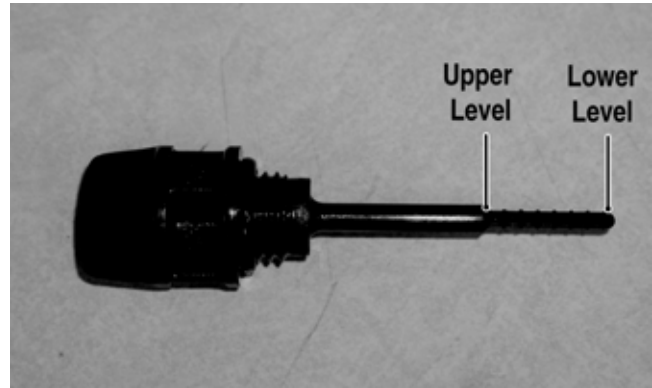

KM022A

11. Inspect the area around the drain plug and oil screen/filter cap for leaks.

## Brake Systems

### **WARNING**

After servicing brake-related components, **ALWAYS** check and adjust brakes as necessary before operating the ATV.

Although the brake systems have been adjusted at the factory, the brakes should be checked for proper operation. The brakes must be maintained to be fully functional.

### **CHECKING FRONT WHEEL BRAKE**

1. With the engine off, compress the right-side (front) brake lever and attempt to move the ATV. If the front wheels are locked, it is adjusted properly.
2. If the front wheels are not locked or if only one wheel locks, adjustment is necessary.

### **CHECKING REAR WHEEL BRAKE**

1. With the engine off, compress the left-side (rear) brake lever and set the brake lever lock; then attempt to move the ATV. If the rear wheels are locked, it is serviceable.
2. If the rear wheels are not locked, bleed the brake system or replace the pads as necessary.

### **ADJUSTING FRONT WHEEL BRAKE**

1. Raise the ATV enough to allow the front wheels to spin freely.
2. Loosen both jam nuts on the right-side (front) brake lever. Turn both cable adjusters counterclockwise until both front wheels do not spin freely.



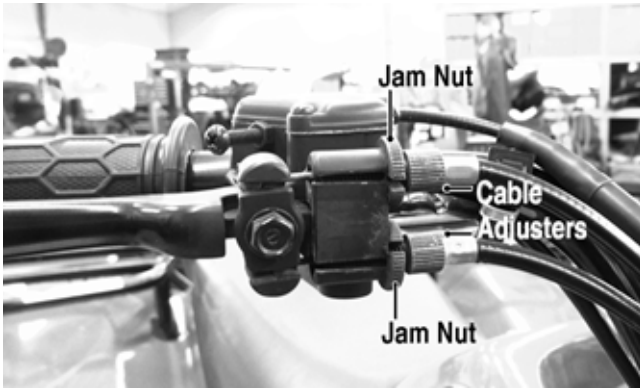

KC555B

3. Turn both cable adjusters in 1/4-turn increments (clockwise) until the wheels spin with a very slight amount of drag.
4. Lower the ATV; then push it forward and compress the brake lever.
5. If the front wheels lock evenly, adjustment is correct.
6. If the front wheels do not lock evenly, additional adjustment is necessary.
7. Once proper adjustment is obtained, tighten the jam nuts.

### Adjusting Parking Brake

■NOTE: The parking brake lever must be in the off position when adjusting the parking brake cable.

1. Loosen the jam nut (A); then finger tighten the adjuster bolt (B) until resistance is felt.

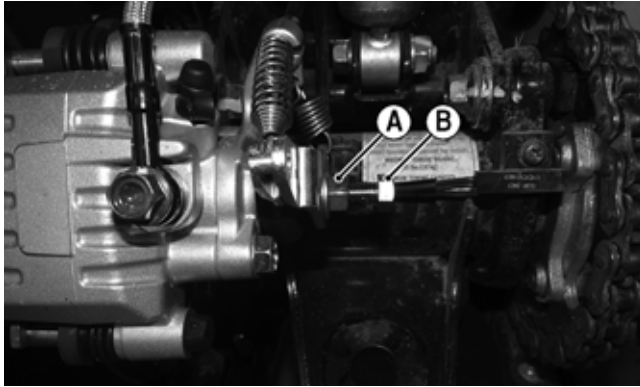

KC553A

2. Loosen the adjuster bolt (B) 1/8-1/4 turn.
3. While holding the adjuster bolt (B), tighten the jam nut (A) securely.

■NOTE: There should be no resistance on the brake disc from the brake pads after adjusting.

### MEASURING/REPLACING BRAKE SHOES/PADS

#### Removing Front Brake Shoes

1. Support the ATV on a support stand.
2. Remove both front wheels and account for the cap screws.
3. Remove the cotter pins, castle nuts, and washers; then remove the brake drums/wheel hubs.

4. Loosen the brake shoe return spring; then remove the brake shoes.



MD2042

#### Removing Rear Brake Pads

1. Remove the two cap screws securing the brake caliper to the axle housing; then lift the caliper off the disc.

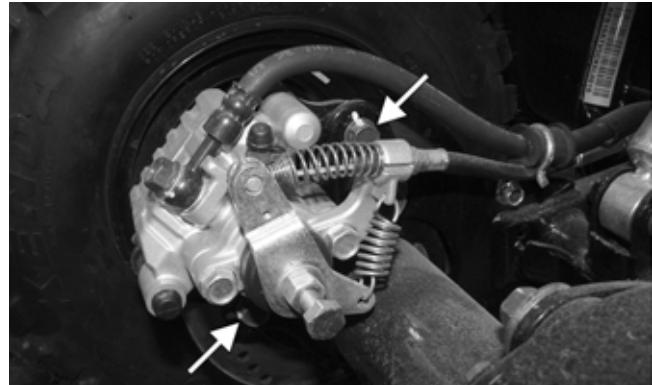

YT235A

2. Remove the two Allen-head retaining pins. Depress the holder pins and disengage the outer pad; then remove the inner pad.



YT236

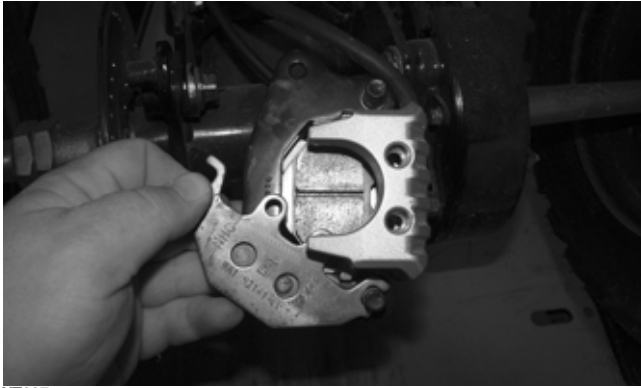

YT237

### Inspecting and Measuring

1. Inspect the pads for gouges, chips, or wear.
2. Inspect the disc for gouges, grooves, cracks, and warpage.
3. Using a calipers, measure the thickness of each brake pad.
4. If the thickness of any brake pad is less than 1.0 mm (0.039 in.), the brake pads must be replaced.

■NOTE: The brake pads and brake rotor should be replaced as a set.

### Installing Front Brake Shoes

1. Place the brake shoes onto the backing plate over the stationary pivot pin and rotating cam.
2. Install the brake return spring.

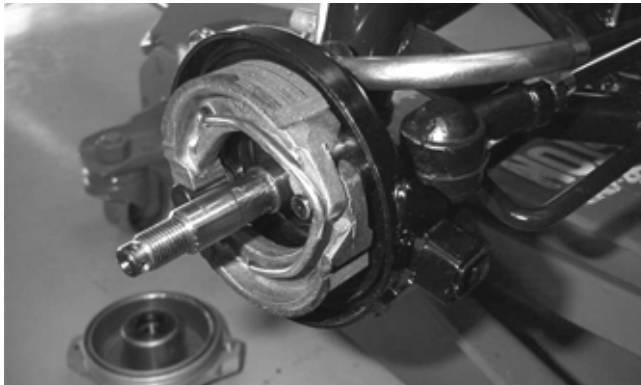

MD2044

3. Install the wheel hub, washer, and castle nut. Tighten the castle nut to 45 ft-lb; then install a new cotter pin.
4. Install the wheel. Tighten to 30 ft-lb.
5. Repeat this procedure for the other side; then adjust the brake.
6. Remove the ATV from the support stand.

### Installing Rear Brake Pads

1. Install the inner brake pad; then install the outer pad onto the holder pins. Apply blue Loctite to the Allen retaining pins; then secure the pins into the caliper.



KC565



YT236

2. Spread the brake pads and place the caliper over the disc; then secure with two new cap screws.

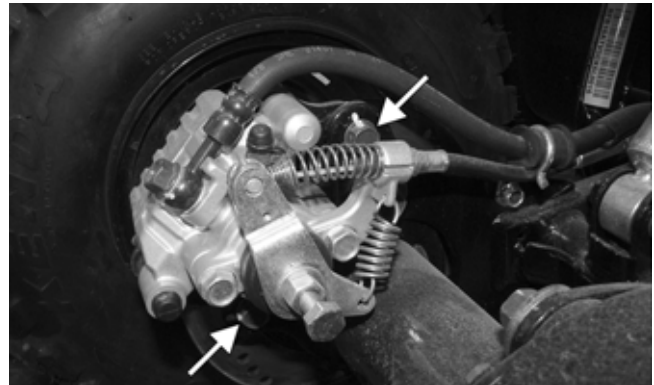

YT235A

■NOTE: Always compress the hydraulic brake lever several times to check that the brakes are firm. If the brakes are not firm, bleeding the system is necessary.

### BLEEDING

To bleed the brake system, use the following procedure:

1. Remove the brake fluid reservoir cover and fill the reservoir with DOT 4 brake fluid.
2. Install and secure the cover.
3. Remove the protective cap from the bleed screw and connect one end of a clear hose to the bleed screw and direct the other end into a suitable container.

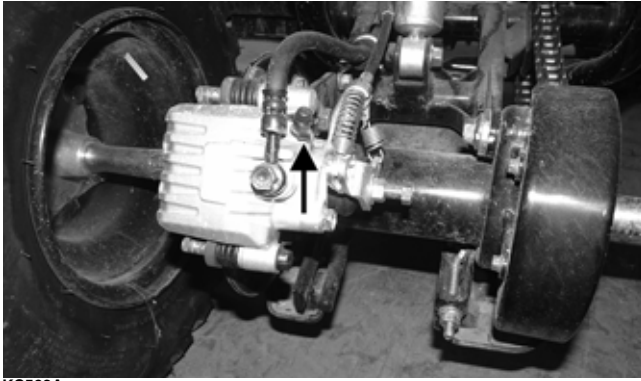

KC562A

4. Slowly compress the brake lever several times; then while holding slight pressure on the brake lever, open the bleed screw and watch for air bubbles in the hose. Close the bleed screw before releasing the brake lever. Repeat this procedure until no air bubbles are present.

■NOTE: During the bleeding procedure, watch the reservoir sight glass to make sure there is always a sufficient amount of brake fluid in the reservoir. Failure to maintain sufficient amount of fluid in the reservoir will result in air being in the system.

5. Repeat step 4 until the brake lever is firm.

## Replacing Drive Belt

### REMOVING

1. Remove the nine Phillips-head cap screws and four cap screws securing the footrest cover to the footrest and front and rear fenders; then remove footrest cover.
2. Remove the cooling duct.
3. Remove the eight cap screws securing the drive belt cover; then remove the cover. Account for a gasket and two alignment pins.

■NOTE: The gasket does not need to be removed unless it is being replaced or unless additional servicing is being done requiring its removal.

4. Remove the nut securing the stationary drive sheave to the crankshaft; then remove the stationary drive sheave. Account for the kick starter ratchet.



YT212

5. Remove the drive belt.



CD624

### CHECKING

Use the Drive Belt Gauge to identify any abnormal wear. Measure across the top of the V-belt (in multiple locations) using a Vernier caliper. Do not squeeze the belt as doing so may produce an inaccurate measurement. The V-belt must be at least 28.5 mm at any point.

### INSTALLING

1. If removed, place the gasket and two alignment pins into position on the crankcase.
2. Spread the faces of the driven clutch with a suitable pry bar or wedge; then when the faces are separated, insert the drive belt.



CD624

■NOTE: If the drive belt has an arrow stamped on the outer face, it should point forward (direction of rotation).

3. Pinch the drive belt together near its center and slide the stationary drive sheave over the crankshaft. Install the kick starter ratchet ensuring the splines are engaged. Secure the stationary drive sheave with a nut (threads coated with red Loctite #271). Tighten the nut to 27.5 ft-lb.

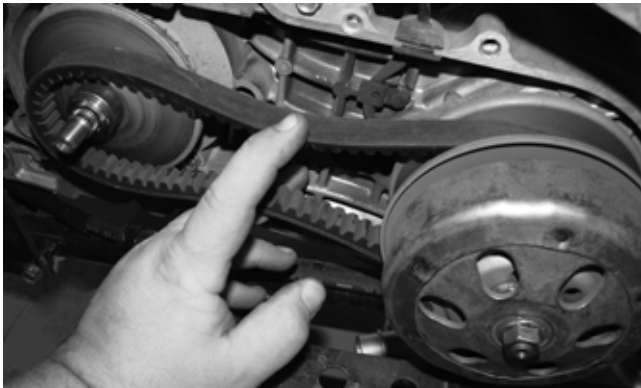

YT213

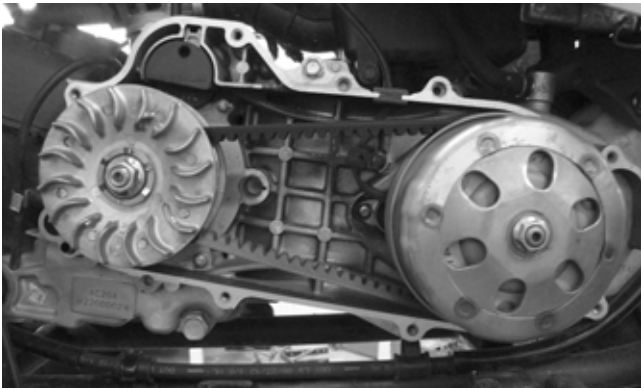

YT214

4. Rotate the drive belt and sheaves until the drive belt is flush with the top of the driven clutch.
5. Place the drive belt cover into position; then secure with the eight cap screws.



CD617

6. Tighten the cover cap screws to 7 ft-lb.
7. Install the cooling duct.
8. Place the footrest cover into position and secure it to the footrest with the Phillips-head cap screws. Tighten securely.
9. Secure the footrest cover to the front and rear fenders with the cap screws. Tighten securely.

---

## Adjusting Shift Linkage

---

If the ATV jumps out of gear, is difficult to get in gear, or the neutral and reverse indicator lights do not illuminate, shift linkage adjustment may be necessary.

1. Shift the transmission into reverse; then remove the cap screw securing the linkage to the transmission shift arm.
2. Verify the transmission is in reverse, the ignition switch is in the ON position, the reverse indicator light is illuminated, and the shift lever is fully in the reverse position; then loosen the upper and lower jam-nuts on the shift linkage and adjust the linkage to align with the shift arm.

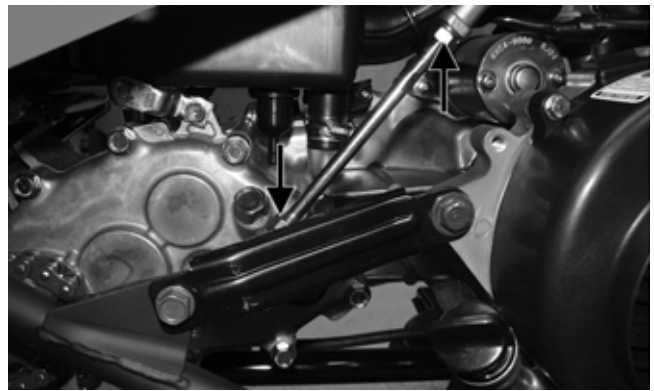

YT005B

3. Install the cap screw securing the linkage to the lower shift arm. Do not tighten at this time.
4. Shift the transmission into neutral and verify the neutral indicator illuminates; then tighten the jam-nuts and the linkage cap screw securely.

---

---

## Steering/Body/Controls

---

The following steering components should be inspected periodically to ensure safe and proper operation:

- A. Handlebar grips worn, broken, or loose.
- B. Handlebar bent, cracked, and an equal and complete full-left and full-right turn capability.
- C. Steering post bearing assembly/bearing housing broken, worn, or binding.
- D. Ball joints worn, cracked, or damaged.
- E. Tie rods bent or cracked.
- F. Knuckles worn, cracked, or damaged.
- G. Cotter pins damaged or missing.

The frame and welds should be checked periodically for damage, bends, cracks, deterioration, broken components, and missing components.

---

---

### Front Fascia

---

#### REMOVING

1. Remove the four caps screws with washers and one self-tapping screw securing each headlight to the front body panel assembly; then remove the two cap screws securing the front fascia to the front body panel. Repeat for opposite side.

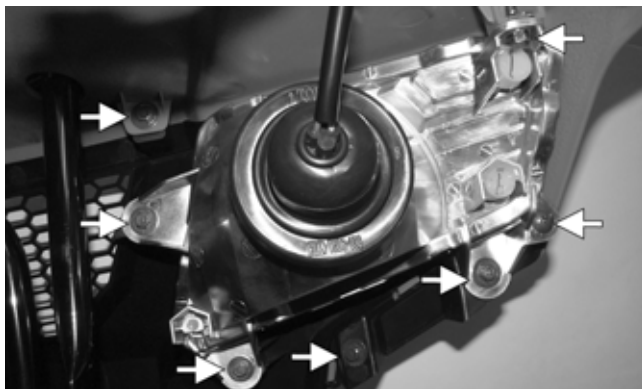

KM978B

2. Remove the four cap screws (A) securing the front fascia to the frame; then release the locking tabs securing the fascia to the body as indicated. Remove the front fascia.

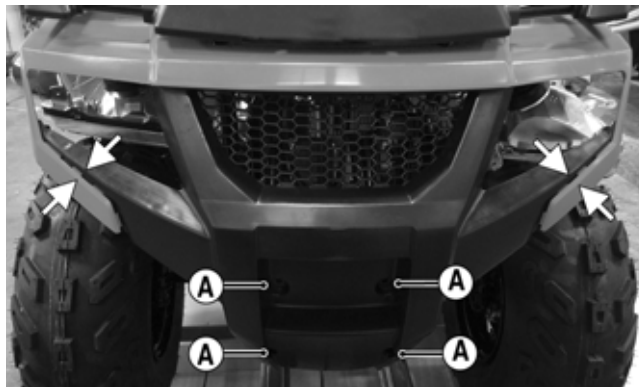

KM977B

#### INSTALLING

1. Position the fascia into the front fender assembly. Snap the outer sections of the front fascia to the fender; then secure the front fascia to the frame using four cap screws (A).

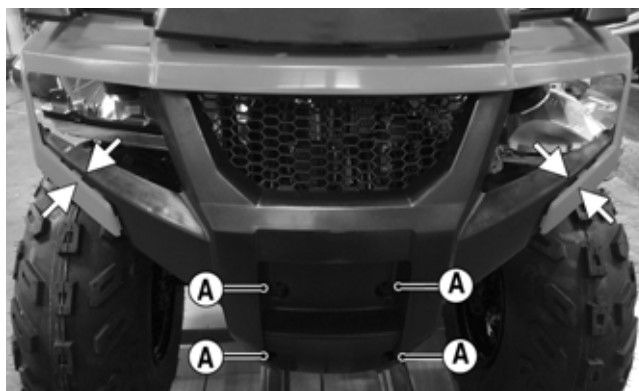

KM977B

2. Place each headlight into position and secure each using the four cap screws and one self-tapping screw per headlight. Secure the front fascia to the body panel using the two cap screws.

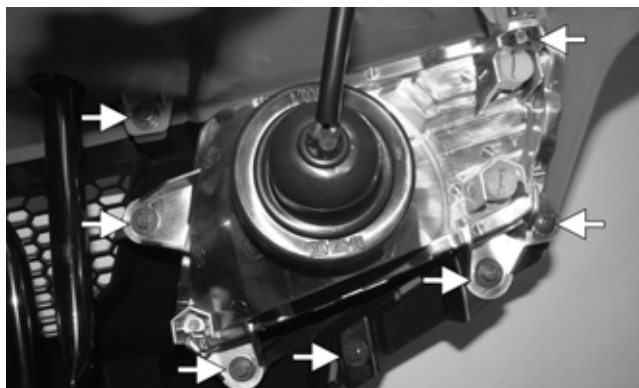

KM978B

---

---

## Body

---

#### REMOVING

1. Remove the seat and battery bracket; then disconnect the battery and remove it from the vehicle.
2. Disconnect the CDI unit; then pull the CDI connector, main relay, and main fuse case through the main body panel.

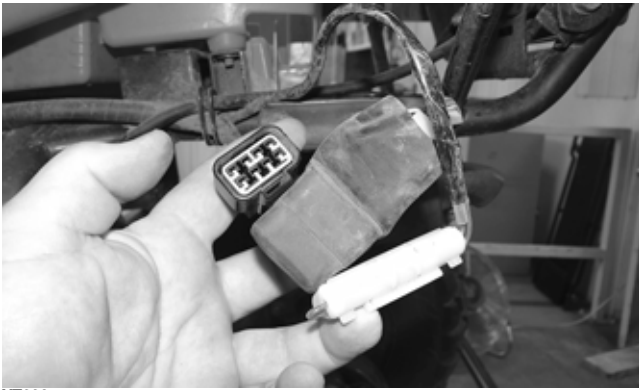

YT223

3. Disconnect both left and right headlight and brake light connectors.

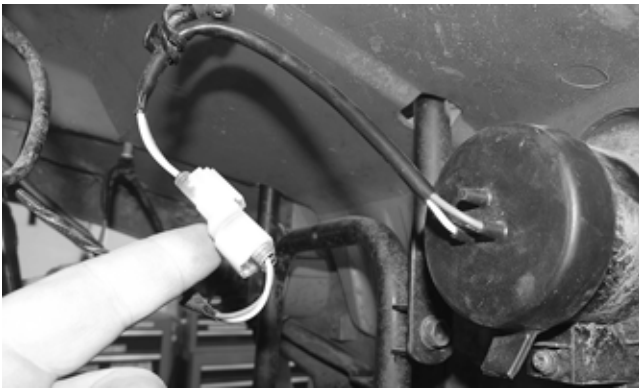

YT224

4. Remove both left and right footwells by removing the Phillips-head screws and cap screws.

5. Remove both front and rear racks. Note the spacers installed in the rubber grommets of the main body panel.

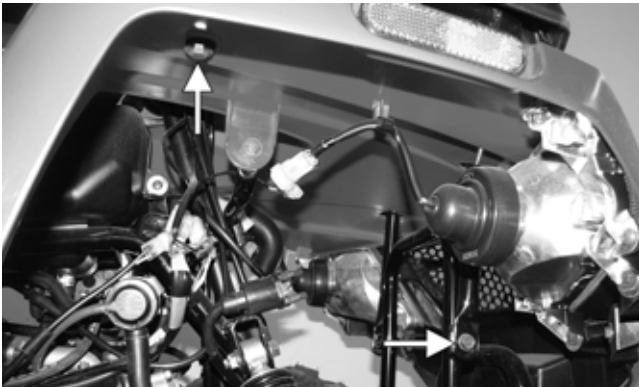

YT247A

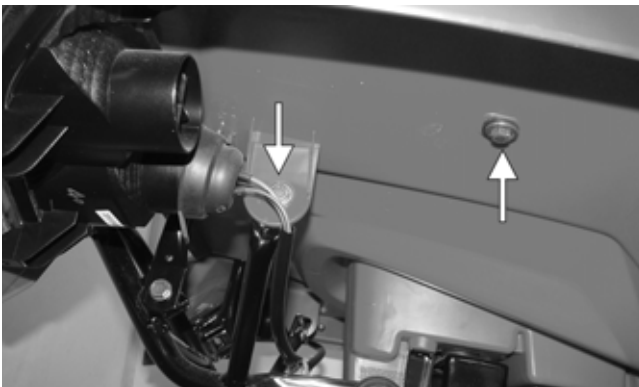

YT248A

6. Disconnect the one 4-pin connector and two 2-pin connectors from the pod and remove from vehicle.

7. Disconnect both brake light switch connectors and left-hand control assembly switch connectors.

8. Remove the two Allen-head cap screws from the hydraulic hand brake assembly.



KM965A

9. Remove the two Phillips-head cap screws securing the throttle cable cover to the housing; then remove the throttle cable.

10. Remove both brake cables from the right side of the handlebar. Match-mark both cable locations.



YT226

11. Remove the Allen-head cap screws securing the handlebar clamps to the handlebar.



YT227

12. Remove the five cap screws from under the seat.



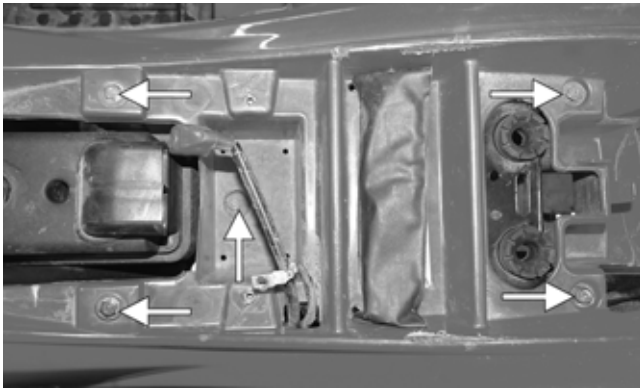

YT228A

13. Remove the cap screws securing the main body panel to the frame. Two cap screws are located under the front fenders, and the other two cap screws are located below the rear fenders.

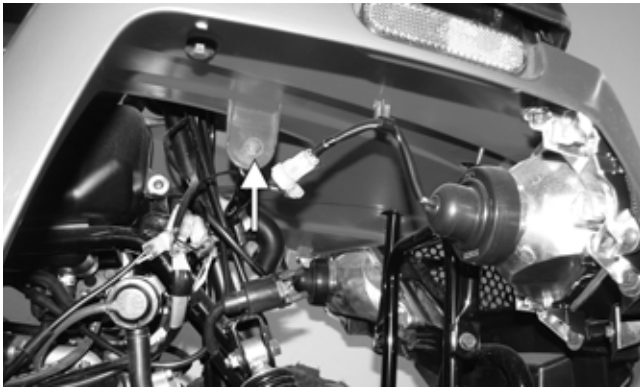

YT247B

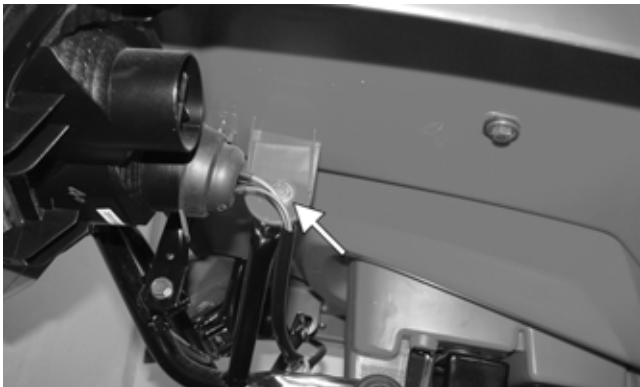

YT248B

14. Remove the four screws securing the front fascia to the frame.

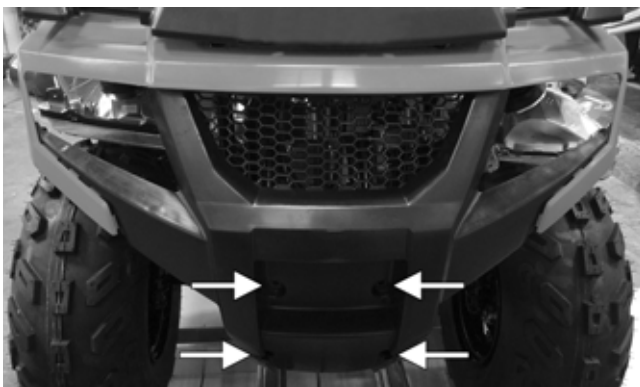

KM977C

15. Remove the gas cap; then slowly lift the front of the main body panel while guiding the throttle cable, brake master cylinder, and brake cables through the front hole in the main body panel. Guide the positive and negative cables through the plastics. Remove the main body panel from the vehicle.

## INSTALLING

1. Route the throttle cable, master cylinder, and brake cables through the front access hole; then set the main body panel onto the vehicle. Route the battery cables through the plastic. Install the gas tank cap.
2. Install, but do not tighten, the five main body cap screws underneath the seat.

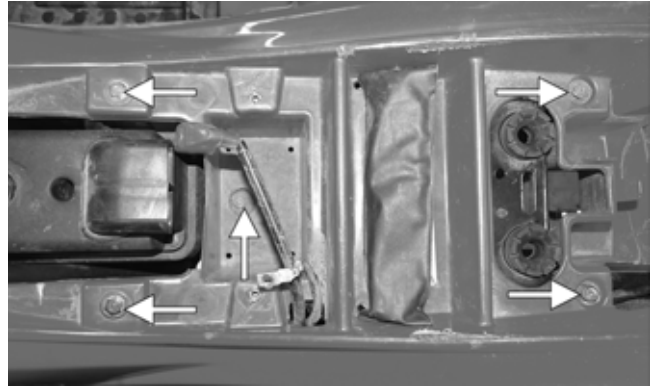

YT228A

3. Install the remaining main body caps screws (two cap screws from under the front fenders, two cap screws from under the rear fenders). Secure the front fascia to the frame. Tighten the cap screws and the cap screws from step 4 to 86 in.-lb.
4. Install both front and rear racks; then secure with the cap screws.
5. Align the handlebar and install both handlebar clamps; then secure with the Allen-head cap screws and tighten to 10 ft-lb.

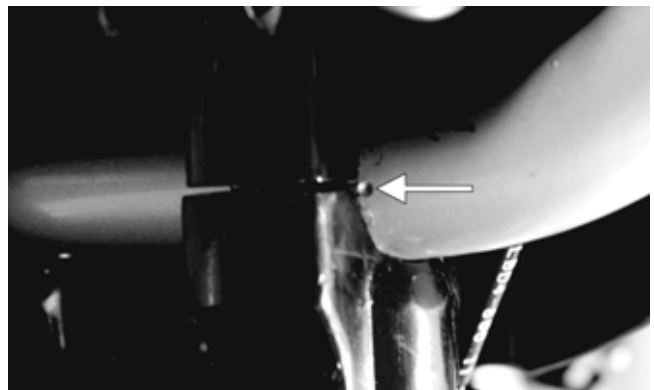

KM060A

6. Using the marked locations, install both brake cables. Install the throttle cable and throttle cable cover. Check and/or adjust throttle cable free-play (see Throttle Cable Free-Play).

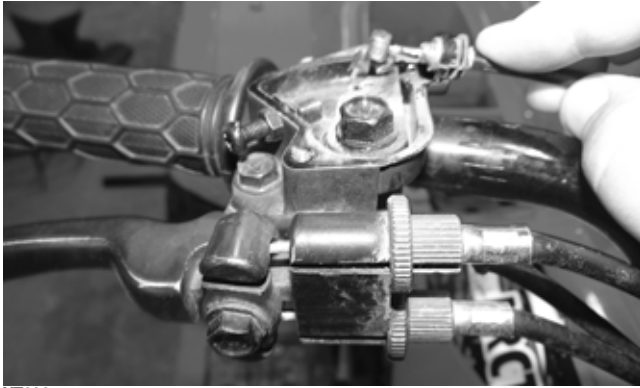

YT226

7. Install the hydraulic hand brake assembly to the handlebar and secure with the cap screws.
8. Connect the brake light switches and handlebar switch connectors.
9. Connect the one 4-pin connector and two 2-pin connectors. Connect both 2-pin headlight connectors.
10. Install the footwells with the Phillips-head screws and cap screws.
11. Route the CDI connector, main relay, and main fuse case through the plastic and connect the CDI unit. Install all three into their locations.



YT223

12. Set the battery in place and first connect the positive cable then the negative cable. Install the battery bracket/rubber strap.

### CAUTION

**Check for proper hydraulic and brake cable operation. Adjust as necessary. Check for proper throttle cable operation. Start the vehicle and check for any signs of fuel leakage. Repair as needed. Verify all electrical components are operational.**

## Steering Post/Handlebar/ Tie Rods

### REMOVING

1. Remove the seat.
2. Remove the control cables from the handlebar; then route them through the metal loop on the steering post and out of the way.

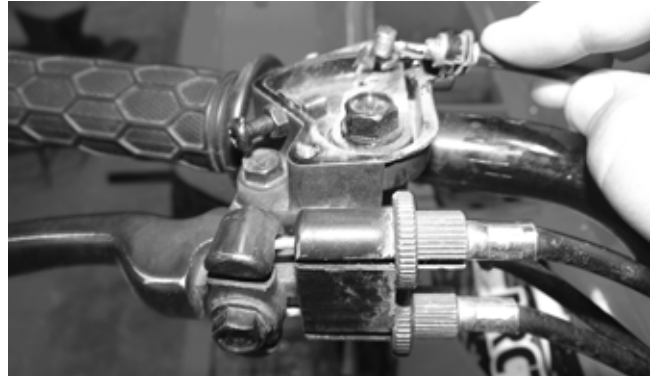

YT226

3. Remove the handlebar cover, bracket, and the handlebar.



YT238

4. Disconnect the handlebar switch assembly and brake switch connectors; then route them through the metal loop on the steering post and out of the way.

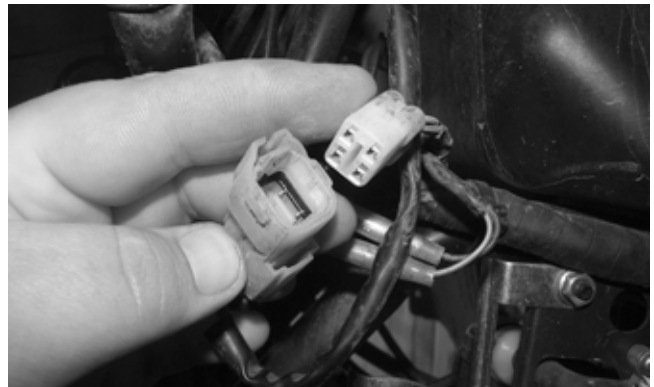

YT218

5. Remove the front and rear racks.
6. Remove the gas tank cap and lift off the main body panel (see Steering/Body/Controls).





YT239A

7. Remove the cotter pins; then remove the two inner tie rod ends from the steering post.



MD2136

8. Remove the cotter pin; then remove the steering post nut.

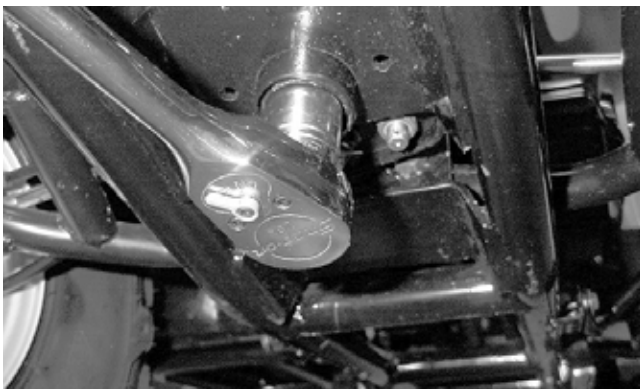

MD2417

9. Remove the front support bracket, steering post outer bearing cap, and the steering post assembly. Account for the two cap screws, the outer and inner bearing caps, and the two-piece plastic bearing.

■**NOTE:** The inner bearing cap and the two spacers do not need to be removed.

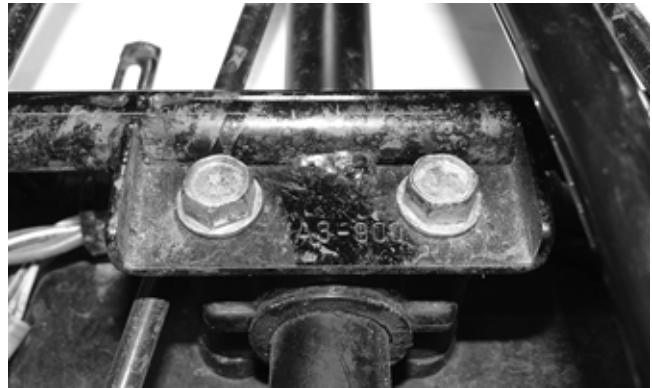

YT234

## CLEANING AND INSPECTING

1. Wash the tie rod ends in parts-cleaning solvent. Dry with compressed air. Inspect the pivot area for wear. Apply a low-temperature grease to the ends.

### **WARNING**

Always wear safety glasses when using compressed air.

2. Inspect the tie rods for damaged threads or wear.
3. Inspect the tie rods for cracks or unusual bends.
4. Inspect all welded areas for cracks or deterioration.
5. Inspect the steering post and brackets for cracks, bends, or wear.
6. Inspect the plastic bearing halves and bearing caps for cracks or wear.
7. Inspect the handlebar tube for cracks, wear, or unusual bends.

## INSTALLING

1. Place the steering post into position. Tighten the two cap screws on the front support bracket making sure the two-piece plastic bearing and the inner and outer bearing caps are in place. Tighten the cap screws to 20 ft-lb.

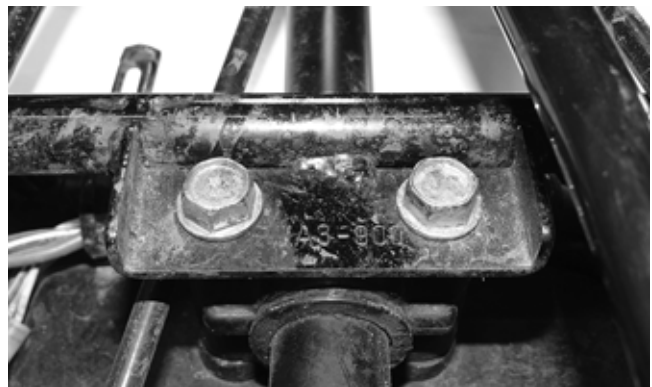

YT234

2. Install the steering post nut and tighten to 51 ft-lb. Install a new cotter pin.

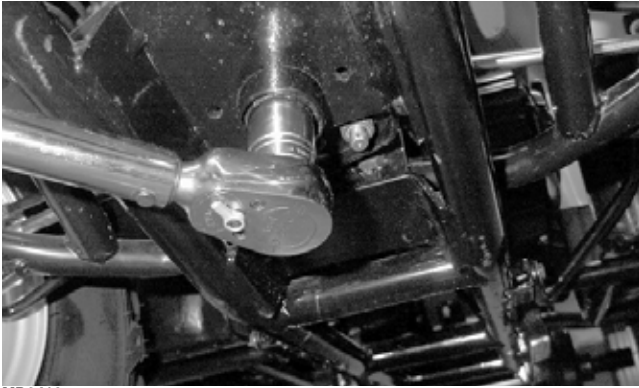

MD2418

3. Install the inner tie rod ends. Tighten the nuts to 20 ft-lb and install new cotter pins.



MD2419

4. Route the control cables and wiring through the metal loop on the steering post.



YT233

5. Install the body panel and gas tank cap (see Steering/Body/Controls).



YT239A

6. Install handlebar with marks aligned with the handlebar mounting clamps. Install the caps; then tighten the cap screws to 10 ft-lb.

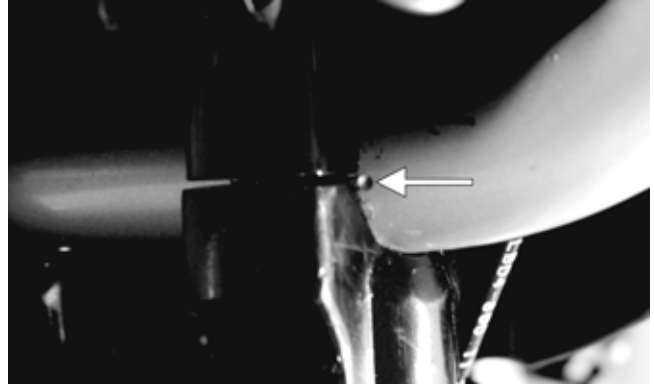

KM060A



YT238

7. Install the control cables onto the handlebar.



YT240A

8. Make sure the cables (brake and throttle) are routed down and away so there is no sticking or binding.

**⚠ WARNING**  
Make sure there is maximum right/left steering capability and the brake and throttle cables are not affected.



YT241A



YT242B

9. Connect the handlebar switch assembly and brake switch connectors.

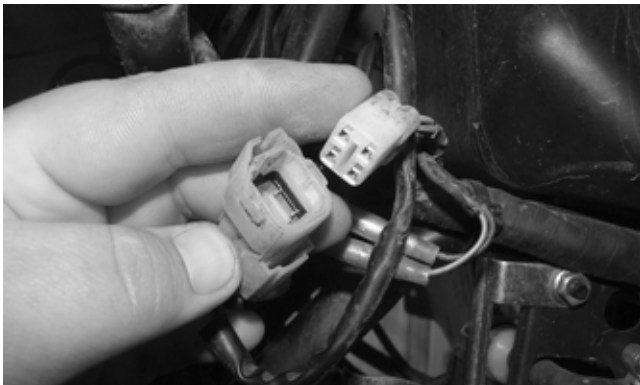

YT218

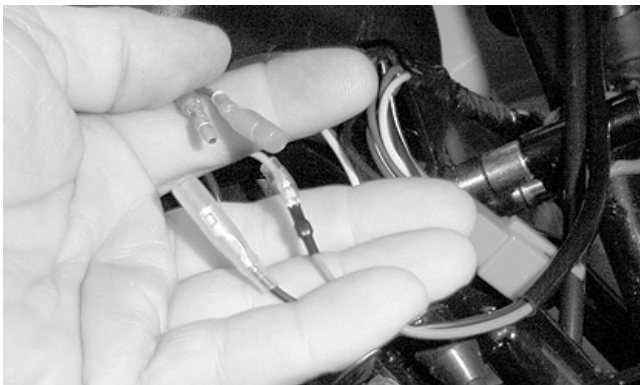

MD2445

10. Install the handlebar bracket, the cover, and the seat.
11. Install the front and rear racks and secure the front fascia to the frame.

---



---

## Handlebar Grip

---

### REMOVING

1. Using a compressed air nozzle and low pressure, peel up the inner corner of the grip.
2. Apply air pressure while twisting the grip back and forth until it slides off the handlebar.

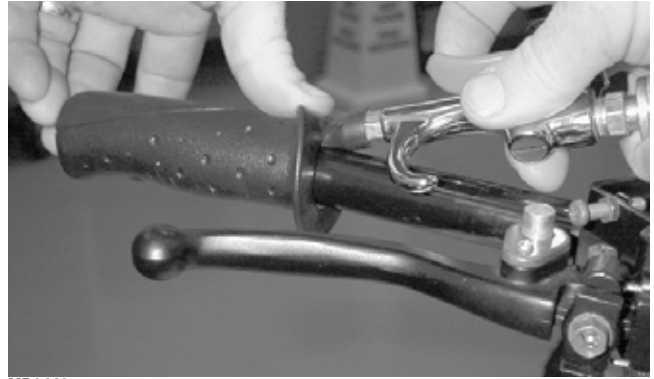

MD2448

### INSPECTING

1. Inspect the grip for wear, cuts, or cracks.
2. Inspect the grip for deterioration.

### INSTALLING

■**NOTE:** Before installing a handlebar grip, use contact spray or alcohol to clean the inside of the grip and the handlebar of glue residue, oil, or any other contaminant.

1. Apply a liberal amount of Handlebar Grip Adhesive to the inside of the grip.
2. Slide the grip onto the handlebar until it is fully seated.
3. Wipe off any excess adhesive.

---



---

## Handlebar Switch

---

### REMOVING

1. Disconnect the handlebar switch assembly wiring connector.

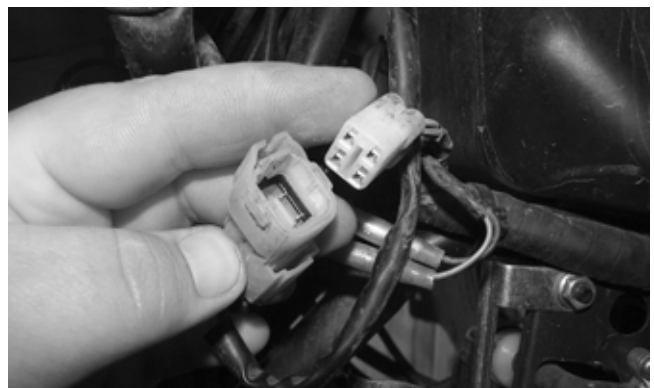

YT218



- Remove the two screws securing the left-hand control assembly to the handlebar.

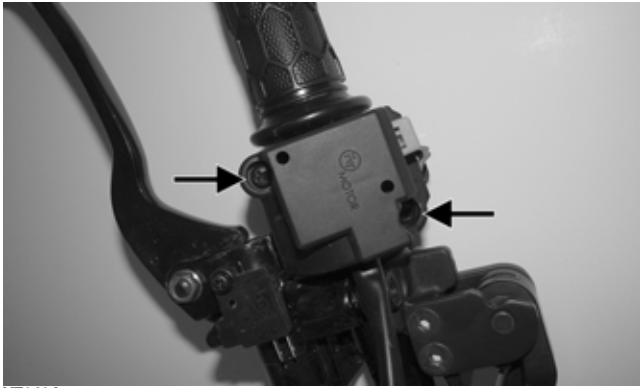

YT243A

## INSTALLING

- Place the alignment pin found on the bottom half of the left-hand control assembly into the alignment hole at the bottom of the handlebar. Place the top half of the assembly onto the handlebar, and secure using the two screws.

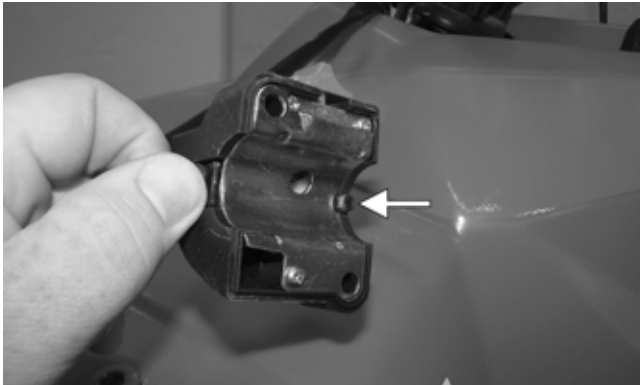

YT244A

- Connect the handlebar switch assembly wiring connector.

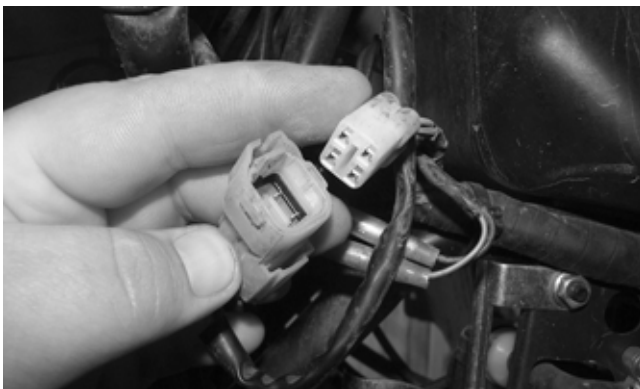

YT218

## Hand Brake Lever Assemblies

### **WARNING**

After removing and installing brake-related components, **ALWAYS** check and adjust brakes as necessary before operating the ATV.

### REMOVING

- Remove the right handlebar end then the handlebar grip.
- Remove the cover from the throttle control housing exposing the throttle cable; then remove the cable.



YT241A



YT240B

- Remove the front brake cables from their adjusters by screwing the adjusters inward to loosen the cables; then pulling them free.



YT245

- Loosen the 6 mm Allen-head screw securing the front brake lever assembly and slide the assembly off the handlebar.



YT246A

- Place a suitable container beneath the left-hand brake master cylinder.
- Remove the brakeline hose bolt; then drain brake fluid into the container. Account for two crush washers.

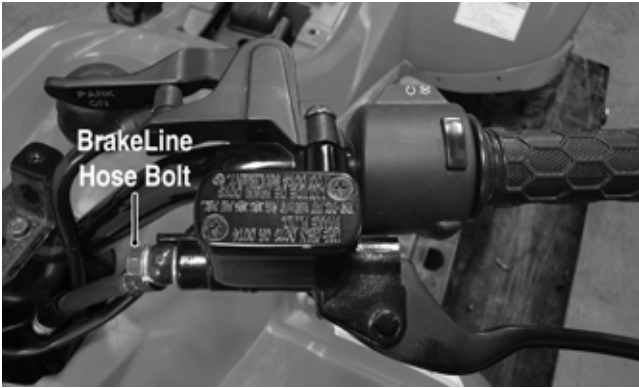

YT242C

- Remove the cap screws securing the left hand brake lever assembly to the handlebar and remove the hand brake/master cylinder assembly.



KM965A



YT246A

## INSTALLING

- Slide the right brake lever assembly onto the handlebar; do not tighten the Allen-head screw completely at this time.



YT246A

- Install the throttle cable onto the throttle lever; then install the cover and secure with the screws.



YT240B



YT241A

- Install the brake cables to the lever assembly.



YT245

4. Position the left brake lever assembly onto the handlebar and secure with the clamp and two cap screws. Tighten securely.
5. Install the brakeline hose on the master cylinder with the brakeline hose bolt and two washers. Do not tighten the bolt at this time.



YT242A

6. Remove the cover from the master cylinder and fill with DOT 4 brake fluid; then install the cover.
7. Place a suitable container under the master cylinder and compress the lever slowly. Brake fluid should flow from the loose connection.
8. Tighten the brakeline hose bolt to 20 ft-lb (from step 5); then check the rear brake operation. The brake lever should be firm and the rear brake should stop the wheels.

■NOTE: If the brake is not firm, the system must be bled (see Brake Systems in Periodic Maintenance/Tune-Up section).

■NOTE: Before installing a handlebar grip, use contact spray or alcohol to clean the inside of the grip and the handlebar of adhesive residue, oil, or any other contaminant.

9. Apply a liberal amount of Handlebar Grip Adhesive to the inside of the grip; then slide the right grip onto the handlebar. Wipe off any excess adhesive.
10. Tighten the right brake lever assembly Allen-head screw (from step 1) securely.

## Headlights

■NOTE: The bulb portion of the headlight is fragile. **HANDLE WITH CARE.** When replacing the headlight bulb, do not touch the glass portion of the bulb. If the glass is touched, it must be cleaned with a dry cloth before installing. Skin oil residue on the bulb will shorten the life of the bulb.

### **WARNING**

**Do not attempt to remove the bulb when it is hot. Severe burns may result.**

To replace a headlight bulb, use the following procedure:

1. Remove the boot from the back of the headlight housing. Push the headlight socket toward the front of the vehicle; then turn it counterclockwise 1/8 turn. Remove the bulb.



YT219

2. Install the new bulb; then align the socket to the housing. Push forward; then rotate the connector clockwise until it is fully seated.

To remove the headlight housing(s), use the following procedure:

1. Remove the headlight from the housing; then remove the four cap screws and one self-tapping screw securing the headlight housing to the body panel/fascia.

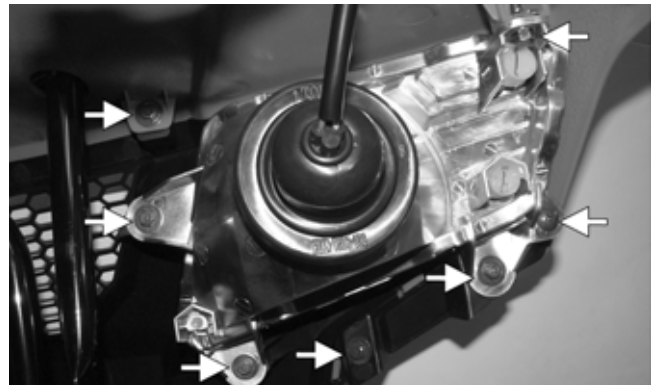

KM978B

2. Place the new housing into position. Secure the four cap screws and one self-tapping screw; then install the headlight.

---

---

## Brake Light/Taillight

---

Rotate the ignition switch to the ON position and compress both brake levers. The brake light should illuminate.

To replace the brake light bulb, use the following procedure:

1. Pull the rubber boot cover off of the brake light housing.
2. Turn the socket counterclockwise. Account for an O-ring; then remove the bulb.



YT249

3. Place the new bulb into position; then with O-ring installed onto the socket, secure by turning the socket clockwise.

4. Install the rubber boot cover.

### CAUTION

**Tighten the lens cover screws only until they are snug.**

To replace the brake light/taillight housing, use the following procedure:

1. Remove the brake light from the housing; then remove the four cap screws securing the brake light housing to the body panel.



YT250A

2. Place the housing into the body panel and secure with four cap screws. Install the brake light into the housing.

# Troubleshooting

<b>Problem: Handling too heavy or stiff</b>	
<b>Condition</b>	<b>Remedy</b>
<ol style="list-style-type: none"> <li>1. <b>Front wheel alignment</b> incorrect</li> <li>2. <b>Lubrication</b> inadequate</li> <li>3. <b>Tire inflation pressure</b> incorrect</li> <li>4. <b>Tie rod ends</b> seizing</li> <li>5. <b>Linkage connections</b> seizing</li> </ol>	<ol style="list-style-type: none"> <li>1. Adjust alignment</li> <li>2. Lubricate appropriate components</li> <li>3. Adjust pressure</li> <li>4. Replace tie rod ends</li> <li>5. Repair — replace connections</li> </ol>
<b>Problem: Steering oscillation</b>	
<b>Condition</b>	<b>Remedy</b>
<ol style="list-style-type: none"> <li>1. <b>Tires</b> inflated unequally</li> <li>2. <b>Wheel(s)</b> wobbly</li> <li>3. <b>Wheel hub cap screw(s)</b> loose — missing</li> <li>4. <b>Wheel hub bearing</b> worn — damaged</li> <li>5. <b>Tie rod ends</b> worn — loose</li> <li>6. <b>Tires</b> defective — incorrect</li> <li>7. <b>A-arm bushings</b> damaged</li> <li>8. <b>Bolts — nuts (frame)</b> loose</li> </ol>	<ol style="list-style-type: none"> <li>1. Adjust pressure</li> <li>2. Replace wheel(s)</li> <li>3. Tighten — replace cap screws</li> <li>4. Replace bearing</li> <li>5. Replace — tighten tie rod ends</li> <li>6. Replace tires</li> <li>7. Replace bushings</li> <li>8. Tighten bolts — nuts</li> </ol>
<b>Problem: Steering pulling to one side</b>	
<b>Condition</b>	<b>Remedy</b>
<ol style="list-style-type: none"> <li>1. <b>Tires</b> inflated unequally</li> <li>2. <b>Front wheel alignment</b> incorrect</li> <li>3. <b>Wheel hub bearings</b> worn — broken</li> <li>4. <b>Frame</b> distorted</li> <li>5. <b>Shock absorber</b> defective</li> </ol>	<ol style="list-style-type: none"> <li>1. Adjust pressure</li> <li>2. Adjust alignment</li> <li>3. Replace bearings</li> <li>4. Repair — replace frame</li> <li>5. Replace shock absorber</li> </ol>
<b>Problem: Steering impaired</b>	
<b>Condition</b>	<b>Remedy</b>
<ol style="list-style-type: none"> <li>1. <b>Tire pressure</b> too high</li> <li>2. <b>Steering linkage connections</b> worn</li> <li>3. <b>Cap screws (suspension system)</b> loose</li> </ol>	<ol style="list-style-type: none"> <li>1. Adjust pressure</li> <li>2. Replace connections</li> <li>3. Tighten cap screws</li> </ol>
<b>Problem: Tire wear rapid or uneven</b>	
<b>Condition</b>	<b>Remedy</b>
<ol style="list-style-type: none"> <li>1. <b>Wheel hub bearings</b> worn — loose</li> <li>2. <b>Front wheel alignment</b> incorrect</li> </ol>	<ol style="list-style-type: none"> <li>1. Replace bearings</li> <li>2. Adjust alignment</li> </ol>
<b>Problem: Steering noise</b>	
<b>Condition</b>	<b>Remedy</b>
<ol style="list-style-type: none"> <li>1. <b>Caps screws — nuts</b> loose</li> <li>2. <b>Wheel hub bearings</b> broken — damaged</li> <li>3. <b>Lubrication</b> inadequate</li> </ol>	<ol style="list-style-type: none"> <li>1. Tighten cap screws — nuts</li> <li>2. Replace bearings</li> <li>3. Lubricate appropriate components</li> </ol>



---

---

## Engine/Transmission

---

This section has been organized into sub-sections which show a progression for the complete servicing of the engine/transmission.

■NOTE: Use new gaskets, lock nuts, and seals and lubricating all internal components when servicing the engine/transmission.

■NOTE: A new ATV and an overhauled ATV engine require a “break-in” period. The first 10 hours (or 200 miles) are most critical to the life of this ATV. Proper operation during this break-in period will help ensure maximum life and performance from the ATV. Instruct the customer to follow the proper break-in procedure as described in the Operator’s Manual.

---

### Removing Engine/ Transmission

---

1. Turn the gas tank valve to the OFF position; then remove the seat and disconnect the negative battery cable securing it away from the battery.

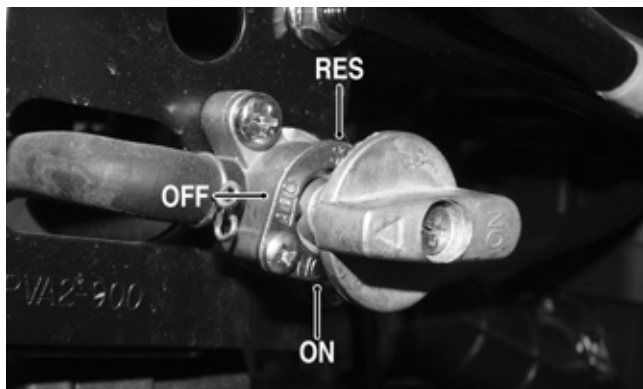

YT251A

**⚠ WARNING**

Battery acid is harmful if it contacts eyes, skin, or clothing. Care must be taken whenever handling a battery.

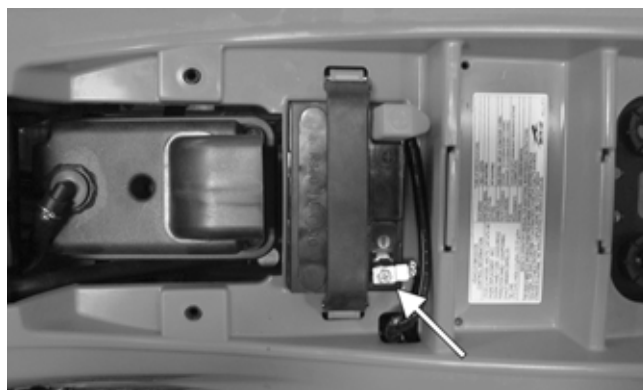

YT252A

2. Drain the transmission lubricant.

■NOTE: The drain plug is located on the bottom of the transmission.

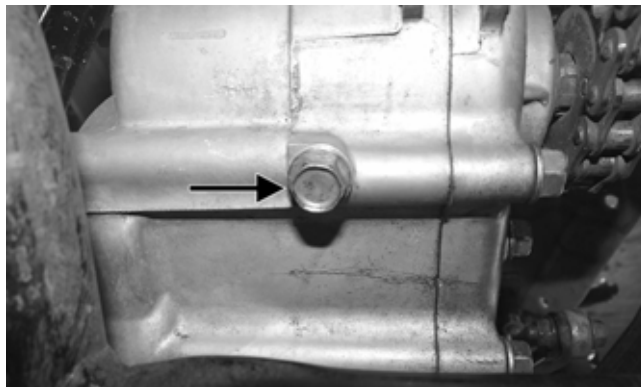

YT215A

3. Drain the engine oil.

■NOTE: The drain plug is located at the left-rear of the engine.



KM041A

4. Remove the left and right footwells and the left-side footwell mounting plate; then remove the drive sprocket and chain from the transmission output shaft.

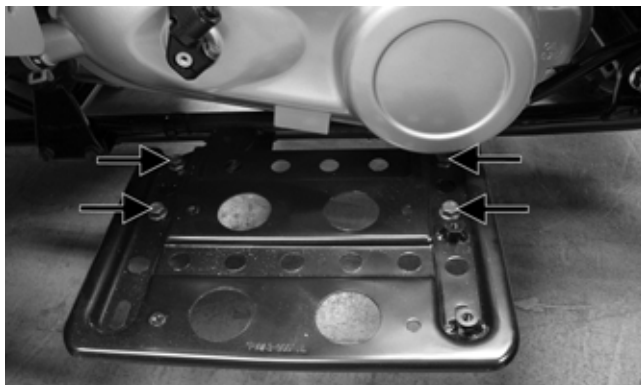

YT002A

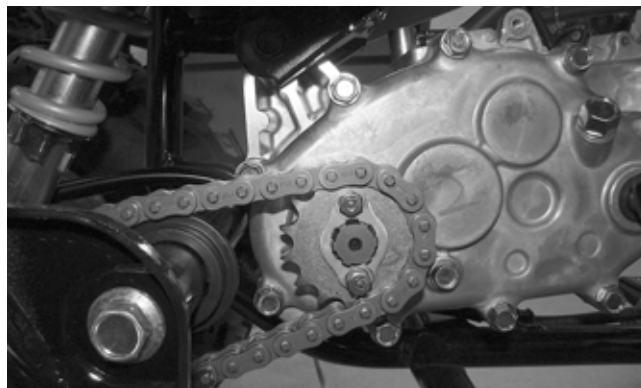

YT009

5. Remove the air filter housing cover and air filter element.
6. Remove the intake boot from the carburetor; then remove the cap screws securing the air filter housing to the crankcase and remove the air filter housing and intake boot.



YT006A



YT253

7. Remove the breather hose from the valve cover; then disconnect the large diameter hose from the AIS valve body located on the bottom of the valve cover. Remove the vacuum line from the base of the intake manifold.



YT254

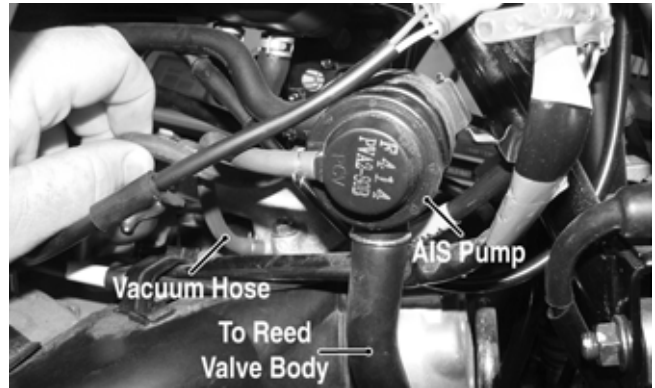

YT255A

8. Remove the exhaust pipe/muffler assembly and related mounting hardware; then remove the shift linkage. Account for a GRAFOIL seal on the exhaust pipe at the cylinder head.

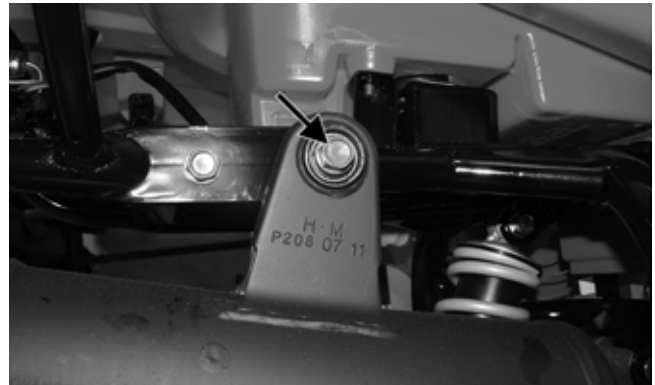

YT008A

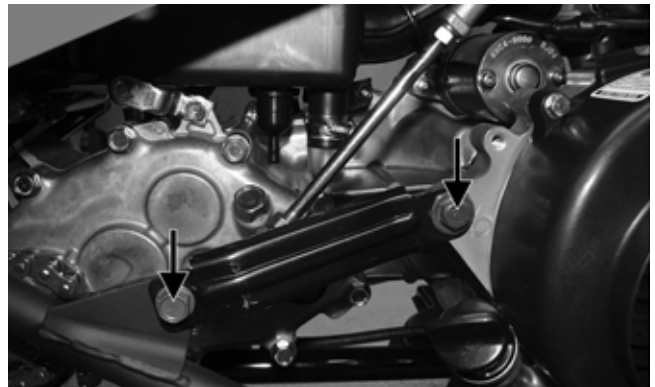

YT005A

9. Disconnect the electric choke connector (C), stator coil connector (B), and starter harness connector (A); then remove the spark plug cap.

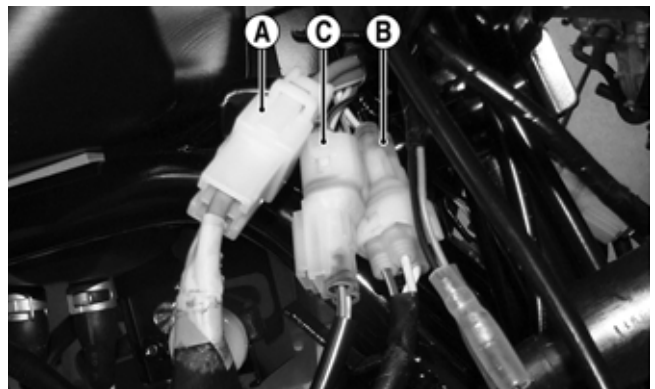

YT010A

10. Remove the fuel hose from the carburetor. Remove the cap screws securing the carburetor to the intake manifold. Account for the spacer and O-rings. Remove the carburetor.
11. Remove the nuts from the one rear and two front through bolts. Do not remove the bolts at this time.
12. Remove the cooling duct from the front of the V-belt housing; then disconnect the gear shift position switch connectors.



YT256

13. Remove the cap screws securing the front engine mounting brackets to the frame; then remove the through bolts and brackets.
14. Slide the engine/transmission forward sufficiently to clear the rear mounting brackets; then swing the rear of the assembly out the left side and remove the engine/transmission from the frame.

---



---

## Top-Side Components

---

■NOTE: For efficiency, it is preferable to remove and disassemble only those components which need to be addressed and to service only those components. The technician should use discretion and sound judgment.

👉 **AT THIS POINT**

To service any one specific component, only limited disassembly of components may be necessary. Note the AT THIS POINT information in each sub-section.

■NOTE: The engine/transmission does not need to be removed from the frame for this procedure.

---



---

## Removing Top-Side Components

---

### A. CAMSHAFT HOLDER/ROCKER ARMS

### B. CYLINDER HEAD/CAMSHAFT

■NOTE: Use new gaskets, lock nuts, and seals and lubricating all internal components when servicing the engine/transmission.

1. Remove the intake pipe. Account for an O-ring between the intake pipe and cylinder head.

2. Remove the cap screws securing the AIS reed valve and reed valve cover to the valve cover. Note the different length cap screws and orientation of the reed valve as shown.

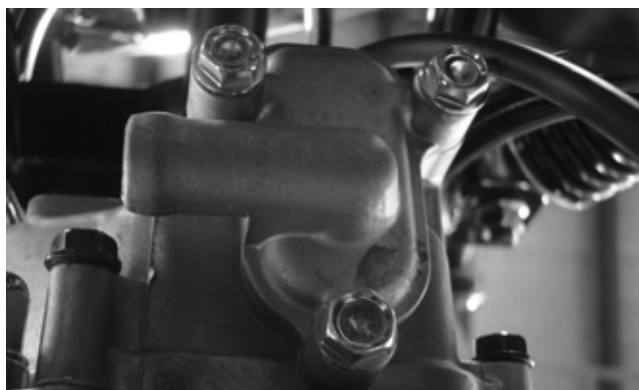

YT257



YT258

3. Remove the two chrome-plated cap screws securing the fresh air pipe to the cylinder head. Account for the gaskets at each end.



YT259

4. Remove the fan shroud; then remove the cylinder/cylinder head shroud. Note the location of the carburetor float bowl drain hose clip.

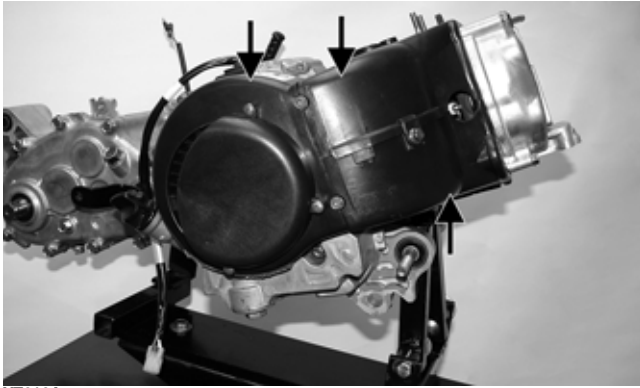

YT016A



YT017A

5. Remove the cylinder head cover. Account for the gasket.
6. Rotate the engine (clockwise) to top-dead-center (TDC) on the compression stroke. The camshaft lobes should be facing away from the rocker arms. Remove the cam chain tensioner assembly.

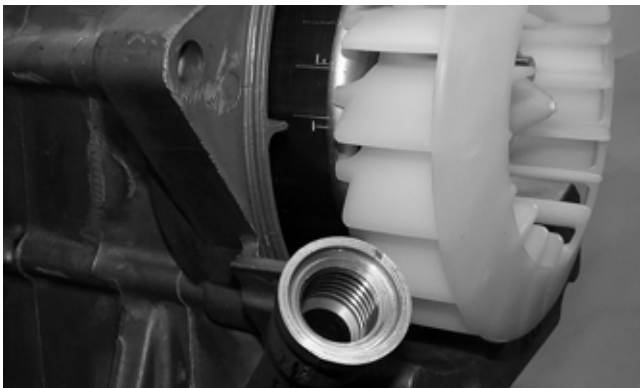

YT095

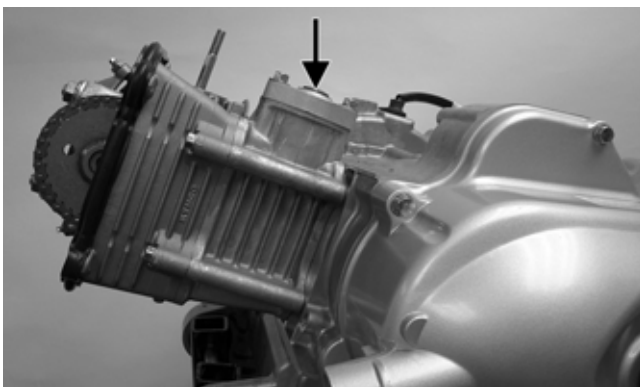

YT098A

7. Remove the cylinder head nuts on top of the camshaft holder. Account for four flat washers.

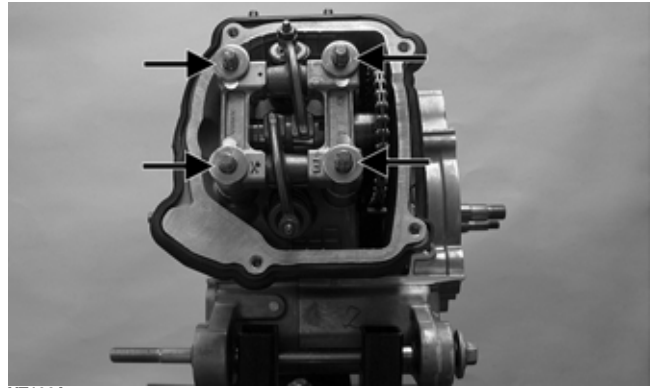

YT106A

8. Remove the camshaft holder noting the location of the two alignment pins. Do not allow the alignment pins to fall into the engine.

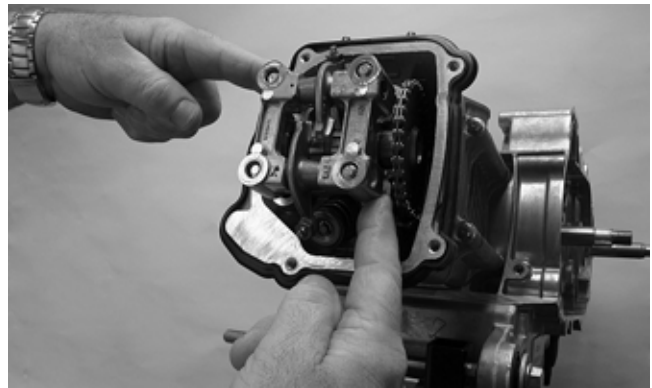

YT107

9. Remove the camshaft from the cylinder head and secure the cam chain to prevent it falling into the crankcase.

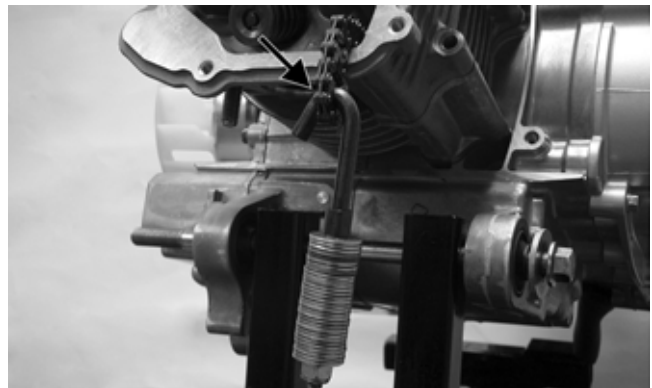

YT168A

### CAUTION

Do not rotate the crankshaft without keeping tension on the cam chain or engine damage could occur.

### 🔧 AT THIS POINT

To service valves and cylinder head, see Servicing Top-Side Components sub-section.



10. Remove the cam chain guide.

**AT THIS POINT**

To inspect cam chain guide, see Servicing Top-Side Components sub-section.



YT112

**C. CYLINDER  
D. PISTON**

■NOTE: Steps 1-8 in the preceding sub-section must precede this procedure.

11. Remove the two cap screws from the left side of the cylinder head; then remove the cylinder head. Account for two alignment pins and remove and discard the cylinder head gasket.

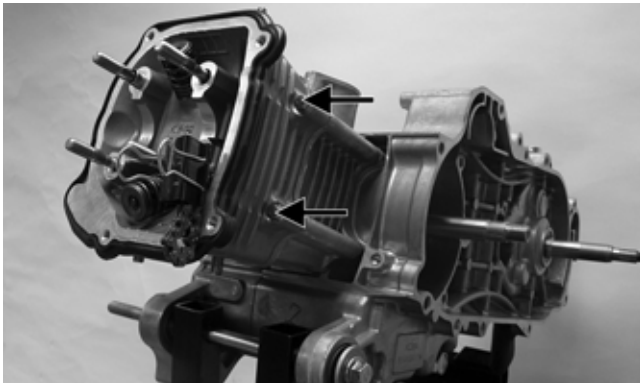

YT109B

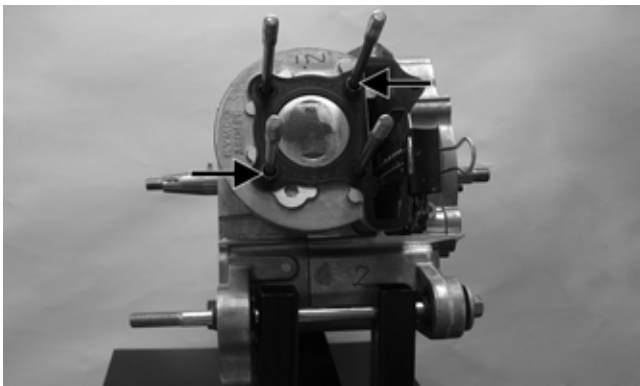

YT110A

12. Lift the cylinder off the crankcase taking care not to allow the piston to drop against the crankcase. Account for the gasket and two alignment pins.

**AT THIS POINT**

To service cylinder, see Servicing Top-Side Components sub-section.

**CAUTION**

When removing the cylinder, be sure to support the piston to prevent damage to the crankcase and piston.

13. Remove the cam chain tensioner pivot bolt; then remove the chain tensioner (see Removing Left-Side Components).

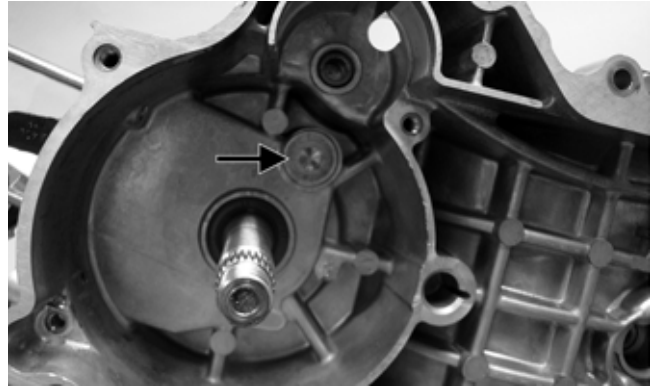

YT114A

14. Using a needle-nose pliers, remove the circlip securing the piston pin in the piston; then remove the piston pin and piston. Take care not to drop the circlip into the crankcase.



YT115

■NOTE: Support the connecting rod with rubber bands or install a connecting rod holder to avoid damaging the rod.

**CAUTION**

Do not allow the connecting rod to go down inside the crankcase. If the rod is down inside the crankcase and the crankshaft is rotated, severe damage will result.

■NOTE: If the existing rings will not be replaced with new rings, note the location of each ring for proper installation. When replacing with new rings, replace as a complete set only. If the piston rings must be removed, remove them in this sequence.

<b>🔧 AT THIS POINT</b>
To service piston, see Servicing Top-Side Components sub-section.

<b>🔧 AT THIS POINT</b>
To service center crankcase components only, proceed to Removing Left-Side Components.

## Servicing Top-Side Components

### VALVE ASSEMBLY

When servicing valve assembly, inspect valve seats, valve stems, valve faces, and valve stem ends for pits, burn marks, or other signs of abnormal wear.

■NOTE: Whenever a valve is out of tolerance, it must be replaced.

### Cleaning/Inspecting Cylinder Head Assembly

Inspect the combustion area of the cylinder head for cracks, burned valves or carbon build-up.

■NOTE: If valves are discolored, they must be replaced. Bring heads to a qualified machine shop for valve replacement or valve seat grinding.

### REMOVING VALVES

■NOTE: Keep all valves and valve components as a set. Note the original location of each valve set for use during installation. Return each valve set to its original location during installation.

1. Using a valve spring compressor, compress the valve springs and remove the valve cotters. Account for an upper spring retainer.

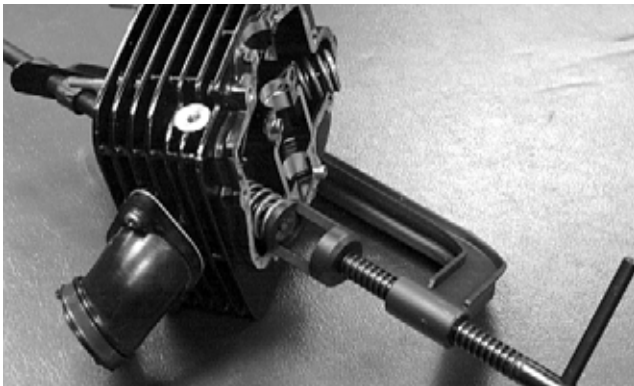

CC391D

2. Remove the valve seal and the lower remaining spring seat. Discard the valve seal.

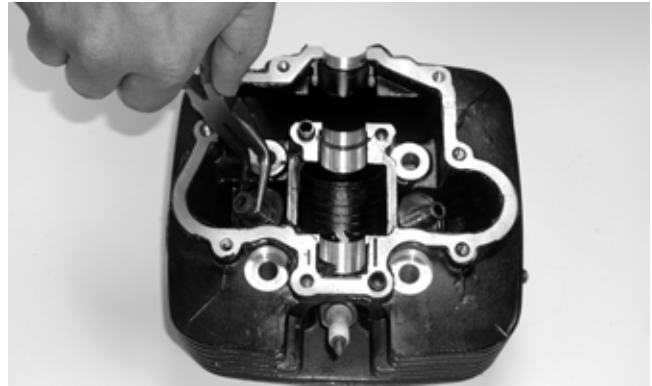

CC928

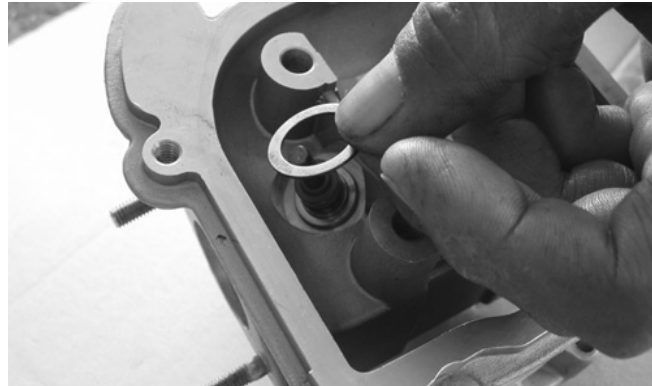

DSC2274

■NOTE: The valve seals must be replaced.

3. Remove the valve springs; then invert the cylinder head and remove the valves.

### Measuring Valve Stem to Guide Clearance

1. Insert a snap gauge 1/2 way down into each valve guide bore; then remove the gauge and measure it with a micrometer.
2. Using a micrometer, measure the valve stem outside diameter. Valve stem to guide clearance must not exceed specifications.
3. If valve stem to guide clearance exceeds specifications, the cylinder head assembly must be replaced.

### Servicing Valves/Valve Guides/Valve Seats

If valves, valve guides, or valve seats require servicing or replacement, take the components to a qualified machine shop for servicing.

<b>CAUTION</b>
If valves are discolored or pitted or if the seating surface is worn, the valve must be replaced. Do not attempt to grind the valves or severe engine damage may occur.

### Measuring Rocker Arm to Shaft Clearance

1. Using a dial calipers, measure the inside diameter of the rocker arm.
2. Using a micrometer, measure the outside diameter of the rocker arm shaft.

3. Subtract the shaft diameter from the rocker arm diameter.
4. Acceptable clearance must be within specifications.

### Installing Valves

1. Apply grease to the inside surface of the valve seals; then place a valve guide seal over each valve guide.

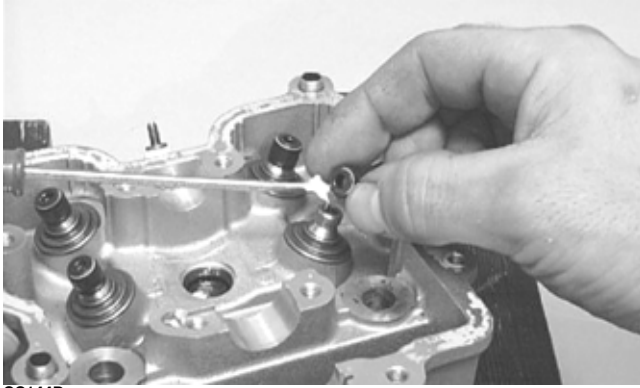

CC144D

2. Insert each valve into its original valve location.
3. Install the valve springs and seats with the closest wound end of the spring directed toward the cylinder head.

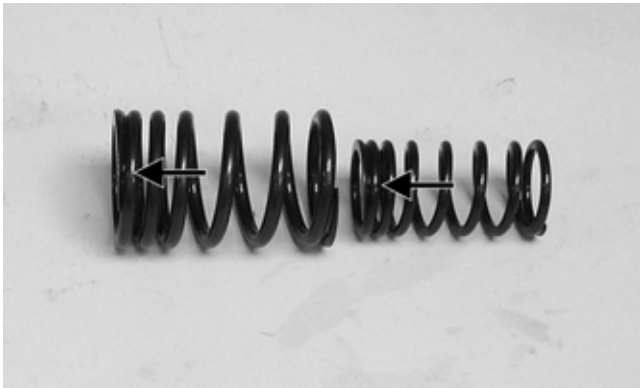

YT141A

4. Place a spring retainer over the valve springs; then using the valve spring compressor, compress the valve springs and install the valve keepers.

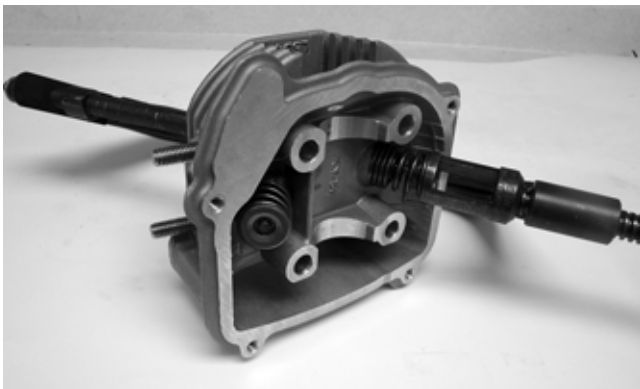

YT138

### PISTON ASSEMBLY

■NOTE: Whenever a piston, rings, or pin are out of tolerance, they must be replaced.

### Inspecting Piston

1. Inspect the piston for cracks in the piston pin, boss, top, and skirt areas.
2. Inspect the piston for seizure marks or scuffing. If piston is scored or galled, replace it with a new one.
3. Inspect the perimeter of each piston for signs of “blowby” indicated by dark discoloration. “Blowby” is caused by worn piston rings, excessive carbon in ring grooves, or an out-of-round cylinder.

### Removing Piston Rings

1. Starting with the top ring, slide one end of the ring out of the ring-groove.



CC400D

2. Remove and discard each ring by working it toward the top of the piston while rotating it out of the groove.

■NOTE: New rings must be installed as a complete set only.

### Measuring Piston-Ring End Gap (Installed)

1. Place each piston ring in the wear portion of the cylinder. Use the piston to position each ring squarely in the cylinder.
2. Using a feeler gauge, measure each piston-ring end gap. Acceptable ring end gap must be within specifications.

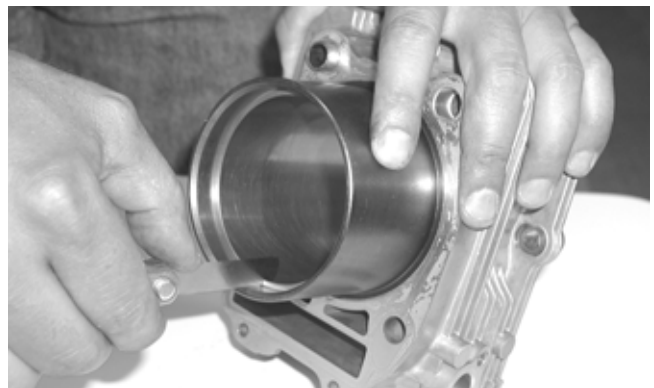

CC995

### Measuring Piston Pin, Connecting Rod Small End, and Piston-Pin Bore

1. Measure the piston pin outside diameter at each end and in the center. If measurement exceeds specifications, the piston pin must be replaced.

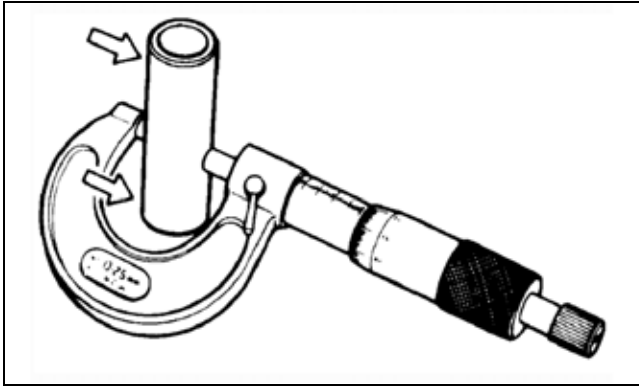

ATV-1070

2. Inspect and measure the connecting rod small end inside diameter. If the measurement exceeds specifications, the connecting rod must be replaced (see Center Crankcase Components in this section).
3. Insert an inside dial indicator into the piston-pin bore. Take two measurements to ensure accuracy. The diameter must not exceed specifications. If the diameter exceeds specifications, the piston must be replaced.

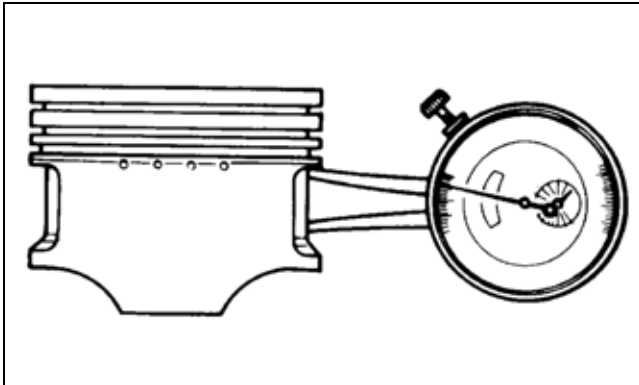

ATV-1069

### Measuring Piston Skirt/Cylinder Clearance

1. Measure the cylinder top to bottom and on an X and Y axis in six places.

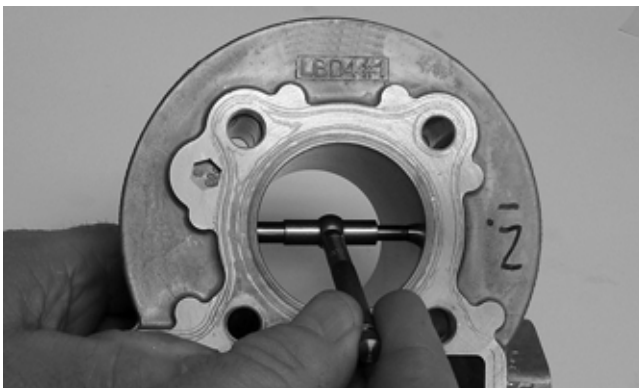

YT137

2. Measure the corresponding piston diameter at a point 15 mm above the piston skirt at a right angle to the piston-pin bore. Subtract this measurement from the measurement in step 1. The difference (clearance) must be within specifications.

### Installing Piston Rings

1. Install ring expander (4) in the bottom groove of the piston; then install the thin oil rings (3) over the expander making sure the expander ends do not overlap. Stagger the end gaps of the upper and lower thin oil rings according to the illustration.

■NOTE: Note the direction of the exhaust side of the piston (5) for correct ring end gap orientation.

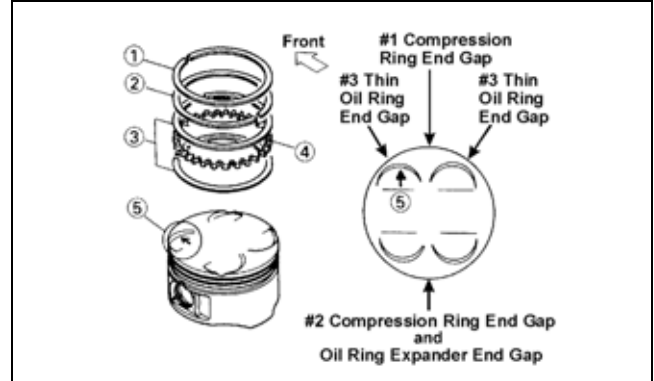

ATV-1085B

2. Install the compression rings (1 and 2) so the letter "T" on the top surface of each ring faces the dome of the piston. Rotate the rings until the ring end gaps are on directly opposite sides of the piston according to the illustration.

■NOTE: The chrome (silver) ring should be installed in the top position.

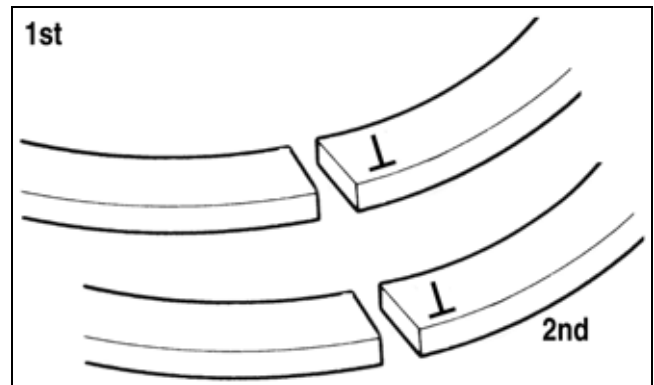

MD1343C

### CAUTION

Incorrect installation of the piston rings will result in engine damage.

### CYLINDER/CYLINDER HEAD ASSEMBLY

■NOTE: If the cylinder/cylinder head assembly cannot be trued, they must be replaced.

### Cleaning/Inspecting Cylinder Head

1. Using a non-metallic carbon removal tool, remove any carbon buildup from the combustion chamber being careful not to nick, scrape, or damage the combustion chamber or the sealing surface.
2. Inspect the spark plug hole for any damaged threads. Repair damaged threads using a "Time-Sert" insert.



- Place the cylinder head on the surface plate covered with #400 grit wet-or-dry sandpaper. Using light pressure, move the cylinder head in a figure-eight motion. Inspect the sealing surface for any indication of high spots. A high spot can be noted by a bright metallic finish. Correct any high spots before assembly by continuing to move the cylinder head in a figure-eight motion until a uniform bright metallic finish is attained.

### CAUTION

Water or parts-cleaning solvent must be used in conjunction with the wet-or-dry sandpaper or damage to the sealing surface may result.

### Measuring Cylinder Head Distortion

- Remove any carbon buildup in the combustion chamber.
- Lay a straightedge across the cylinder head; then using a feeler gauge, check the distortion between the head and the straightedge.
- Maximum distortion must not exceed specifications.



YT123

### Cleaning/Inspecting Cylinder

- Wash the cylinder in parts-cleaning solvent.
- Inspect the cylinder for pitting, scoring, scuffing, warping, and corrosion. If marks are found, repair the surface using a cylinder hone.
- Place the cylinder on the surface plate covered with #400 grit wet-or-dry sandpaper. Using light pressure, move the cylinder in a figure-eight motion. Inspect the sealing surface for any indication of high spots. A high spot can be noted by a bright metallic finish. Correct any high spots before assembly by continuing to move the cylinder in a figure-eight motion until a uniform bright metallic finish is attained.

### CAUTION

Water or parts-cleaning solvent must be used in conjunction with the wet-or-dry sandpaper or damage to the sealing surface may result.

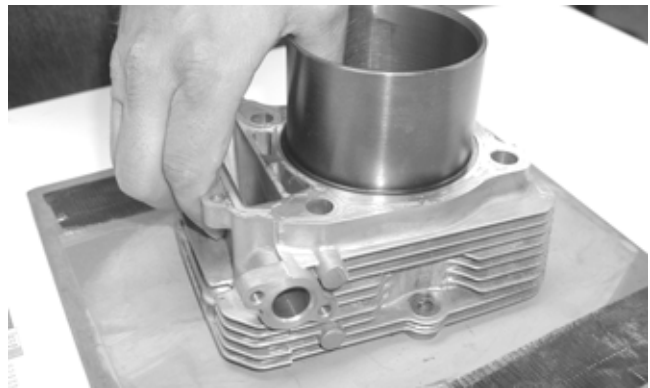

CC997

### Inspecting Cam Chain Guide

- Inspect cam chain guide for cuts, tears, breaks, or chips.
- If the chain guide is damaged, it must be replaced.

### Honing Cylinder

- Using a slide gauge and a dial indicator or a snap gauge, measure the cylinder bore diameter in three locations from top to bottom and again from top to bottom at 90° from the first measurements for a total of six measurements. The trueness (out-of-roundness) is the difference between the highest and lowest reading. Maximum trueness (out-of-roundness) must not exceed specifications.

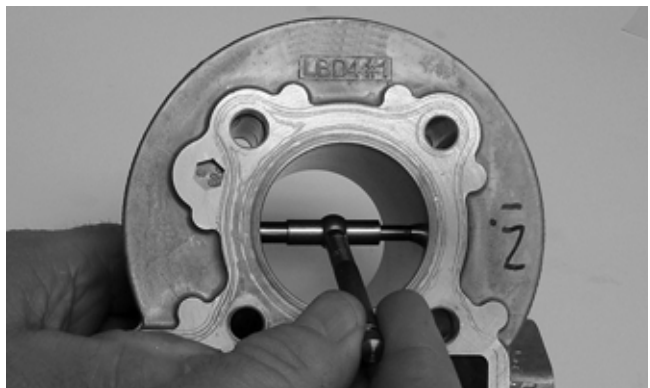

YT137

- Wash the cylinder in parts-cleaning solvent.
- Inspect the cylinder for pitting, scoring, scuffing, and corrosion. If marks are found, repair the surface using a #320 grit ball hone.

■NOTE: To produce the proper 60° crosshatch pattern, use a low RPM drill (600 RPM) at the rate of 30 strokes per minute. If honing oil is not available, use a lightweight petroleum-based oil. Thoroughly clean cylinder after honing using soap and hot water. Dry with compressed air; then immediately apply oil to the cylinder bore. If the bore is severely damaged or gouged, replace the cylinder.

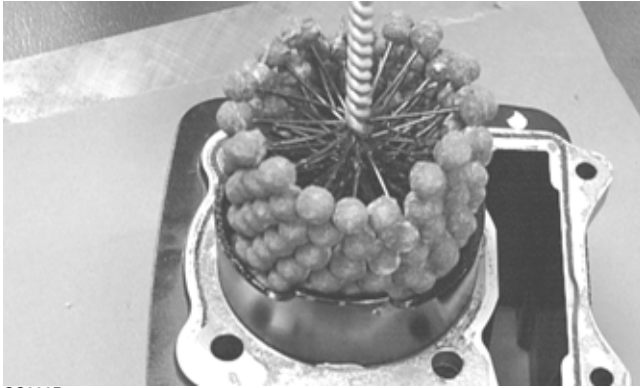

CC390D

4. At this point, repeat step 1 and if any measurement exceeds the limit, the cylinder must be replaced.

### Measuring Camshaft Lobe Height

1. Using a micrometer, measure each cam lobe height.



YT129

2. The lobe heights must exceed minimum specifications.

### Inspecting Camshaft Bearing/Sprocket

1. Inspect the camshaft bearings for roughness during rotation or signs of discoloration.

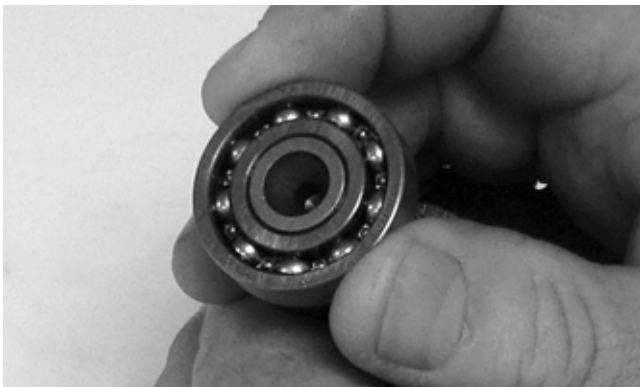

YT128

2. Inspect the timing sprocket for excessive wear.

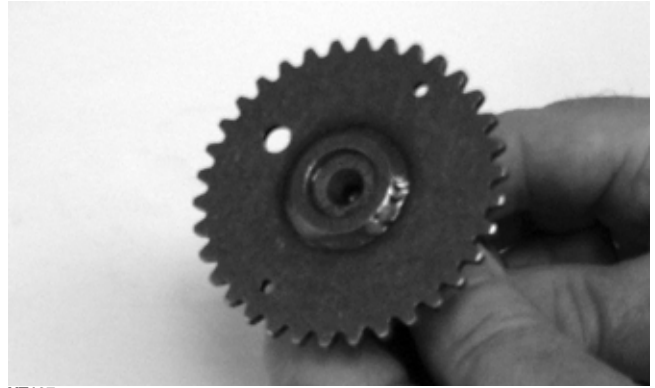

YT127

## Installing Top-Side Components

### A. PISTON

### B. CYLINDER

1. Lubricate the piston pin, connecting rod, and piston pin bore with motor oil; then install the piston on the connecting rod making sure there is a circlip on each side and the open end of the circlip is directed upwards or downwards.

■NOTE: The piston should be installed so the word "IN" points toward the intake side of the engine or upward.



YT161



YT159

2. Place the two alignment pins into position. Place a new cylinder gasket into position; then place a piston holder (or suitable substitute) beneath the piston skirt and square the piston in respect to the crankcase.



YT161A

3. Lubricate the inside wall of the cylinder; then using a ring compressor or the fingers, compress the rings and slide the cylinder over the piston. Route the cam chain up through the cylinder cam chain housing; then remove the piston holder and seat the cylinder firmly on the crankcase.

### CAUTION

The cylinder should slide on easily. Do not force the cylinder or damage to the piston, rings, cylinder, or crankshaft assembly may occur.

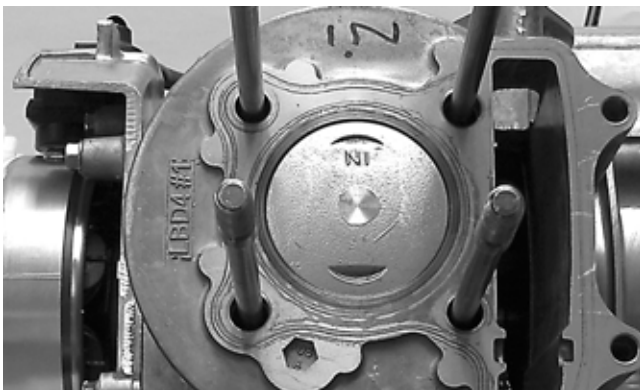

YT158

### C. CYLINDER HEAD/CAMSHAFT D. CAMSHAFT HOLDER/ROCKER ARMS

■NOTE: Steps 1-3 in the preceding sub-section must precede this procedure.

4. While keeping tension on the cam chain, place the front cam chain guide into the cylinder.

### CAUTION

Care should be taken that the bottom of the chain guide is secured in the crankcase boss.



YT112

5. Place a new gasket into position on the cylinder. Place the alignment pins into position; then place the head assembly into position on the cylinder making sure the cam chain is routed through the chain cavity.

### CAUTION

Keep tension on the cam chain to avoid damaging the crankcase boss.

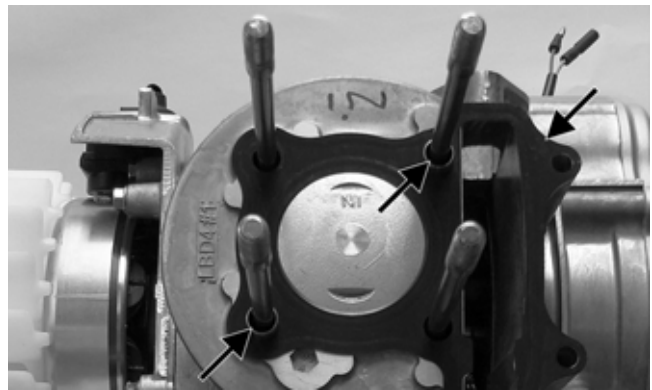

YT167A

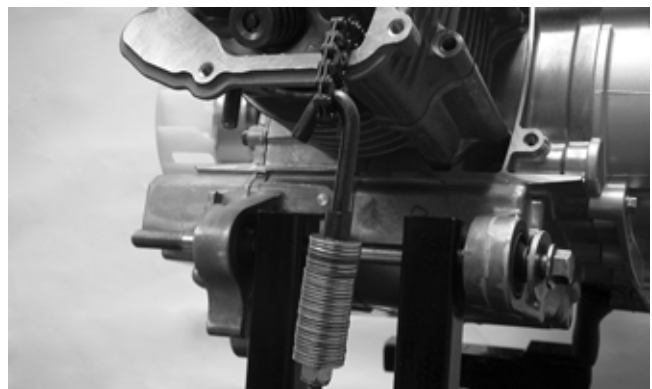

YT168

6. Install two alignment pins into the top of the cylinder head as illustrated.

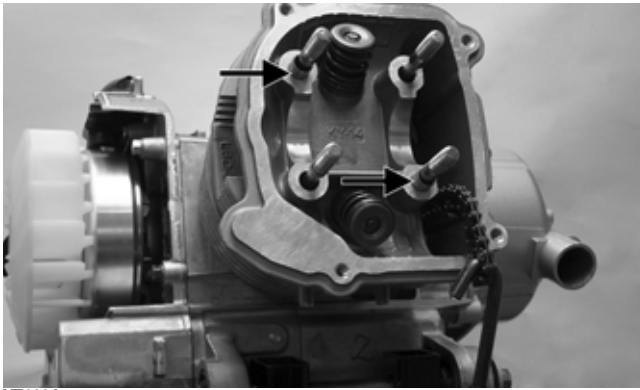

YT169A

7. Make sure the crankshaft is positioned at TDC; then install the camshaft with the single large reference hole (A) directed up and the two small timing holes (B) parallel to the top of the cylinder head.

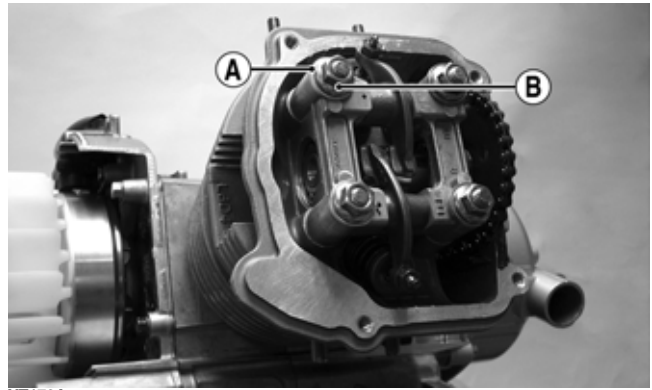

YT172A

9. Install the two cap screws securing the left side of the cylinder head and cylinder to the crankcase and tighten to 7 ft-lb.

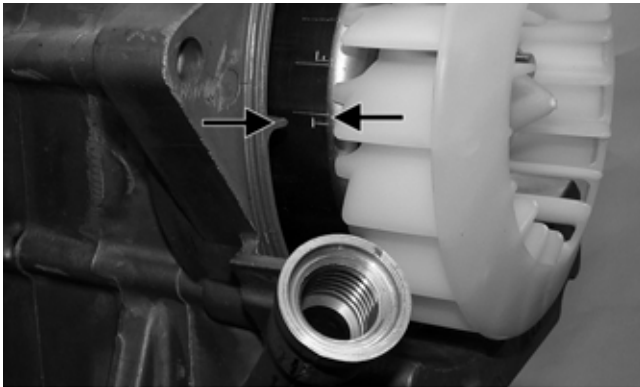

YT095A

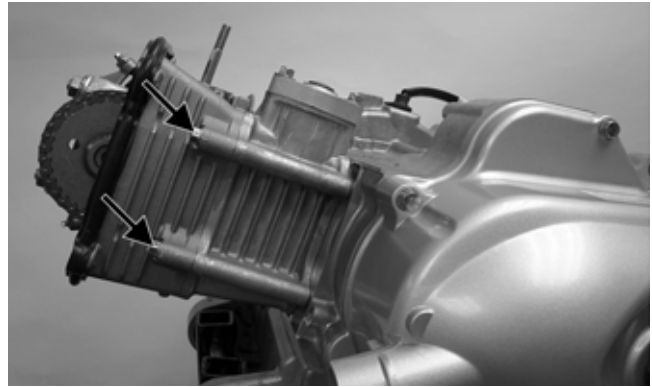

YT098B

10. Install the cam chain tensioner assembly into the cylinder using a new gasket; then secure with two cap screws and tighten to 7 ft-lb.

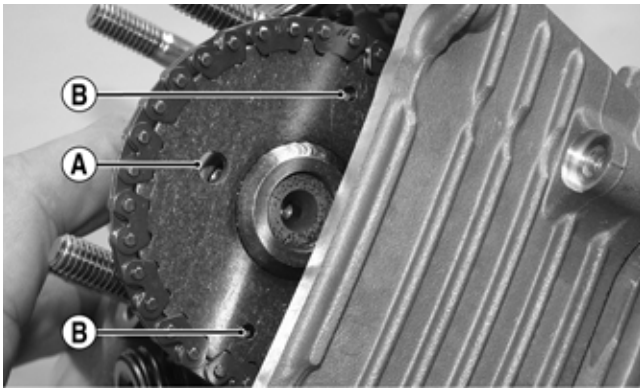

YT173A

8. Place the camshaft holder into position on the cylinder head making sure the camshaft bearings are seated correctly; then install four flat washers (A) and four nuts (B). Tighten in a crisscross pattern to 15 ft-lb.

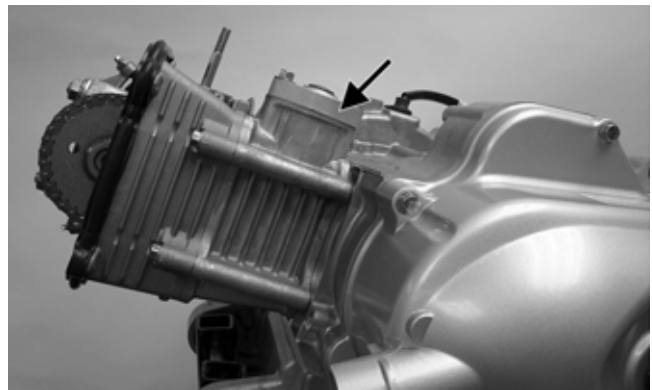

YT098C

11. Using a small flat screwdriver, release the cam chain tension spring by rotating clockwise; then install the plug bolt and tighten securely.

12. Adjust the valve/tappet clearance (see Periodic Maintenance/Tune-Up); then install the valve cover with new gasket. Tighten the cap screws to 7 ft-lb.



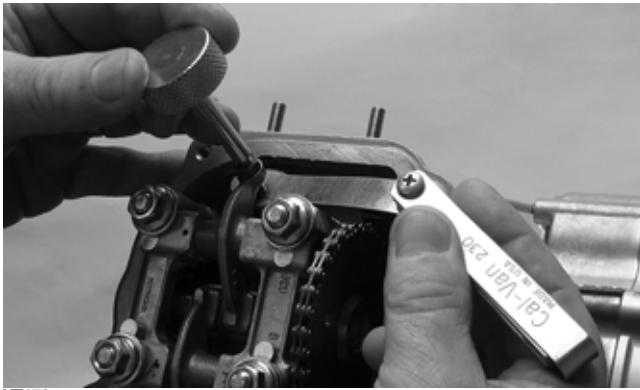

YT170

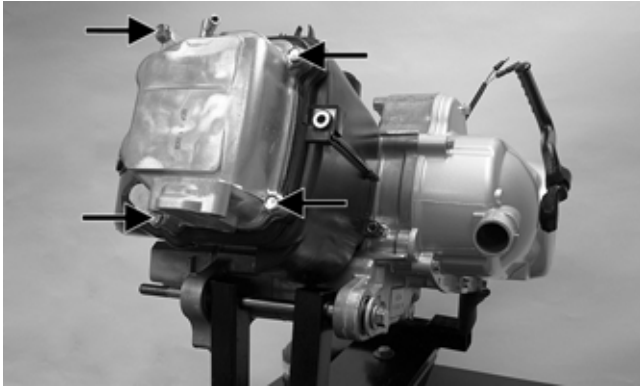

YT090A

13. With new gaskets in place on each end of the AIS fresh air pipe, set the AIS fresh air pipe into position. Loosely thread the chrome-plated nuts to the cylinder head.



YT259

14. Place the AIS reed valve and reed valve cover onto the valve cover; then secure with the three cap screws. Tighten the nuts (from step 13) to 84 in.-lb.



YT257

15. Install the intake pipe/carburetor assembly onto the cylinder head using a new O-ring. Tighten the flange nuts to 7 ft-lb.

## Left-Side Components

■NOTE: For efficiency, it is preferable to remove and disassemble only those components which need to be addressed and to service only those components. The technician should use discretion and sound judgment.

### 🔧 AT THIS POINT

To service any one specific component, only limited disassembly of components may be necessary. Note the AT THIS POINT information in each sub-section.

■NOTE: The engine/transmission does not have to be removed from the frame for this procedure.

## Removing Left-Side Components

- A. V-BELT COVER
- B. V-BELT/DRIVE CLUTCH/DRIVEN PULLEY
- C. CENTRIFUGAL CLUTCH
- D. GEAR POSITION SWITCH
- E. STARTER ONE-WAY CLUTCH

1. Remove the V-belt cover noting the location of the different-length cap screw and the location of the alignment pins. Account for a gasket.

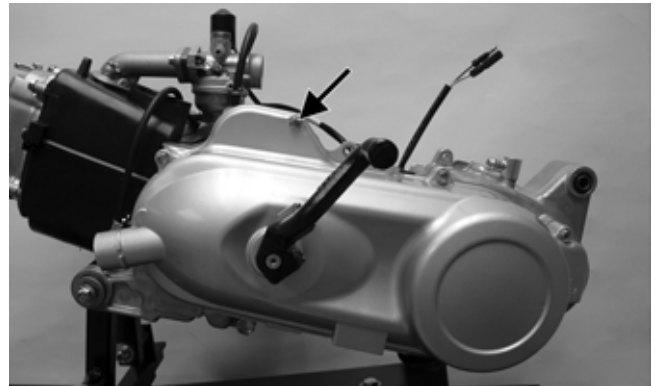

YT099A

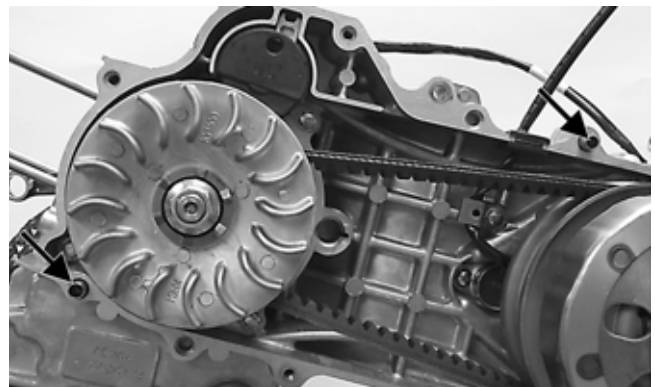

YT160A



- Remove the flange nut (A) securing the fixed drive face to the crankshaft. Account for the kick-start ratchet (B).

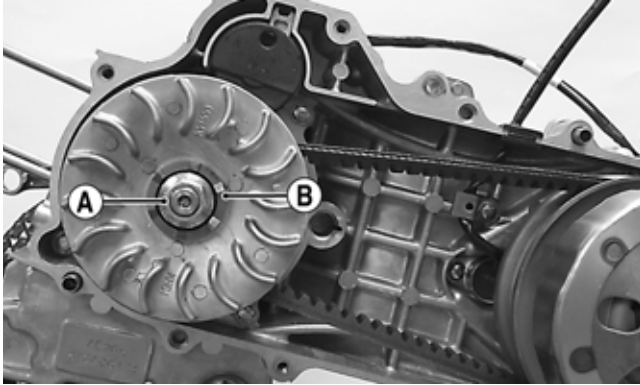

YT160B

- Remove the V-belt; then remove the movable drive face (A). Account for a bushing (B) and speed limiter spacer (C).

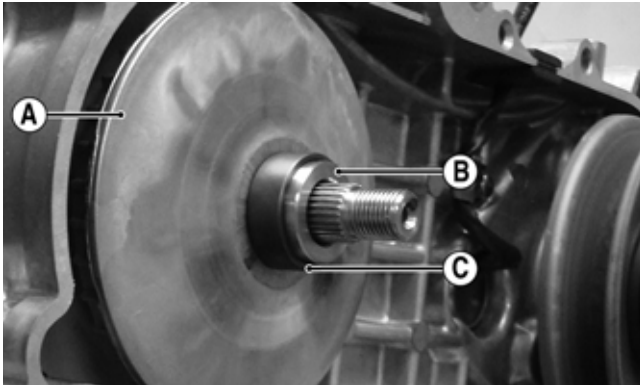

YT021A

- Remove the centrifugal clutch housing; then remove the centrifugal clutch shoe/driven pulley assembly.

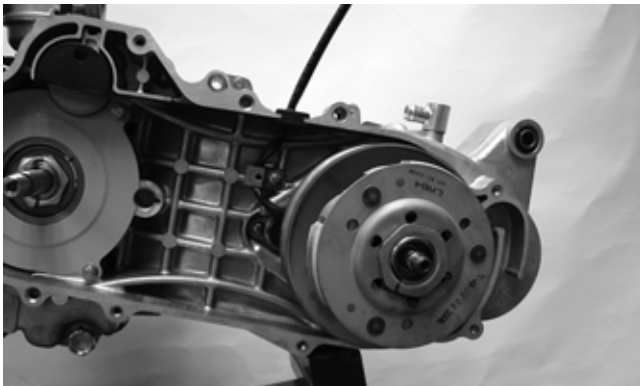

YT022

- Remove the starter reduction gear shield; then remove the starter countershaft housing. Account for a thrust washer (A) and countershaft (B).

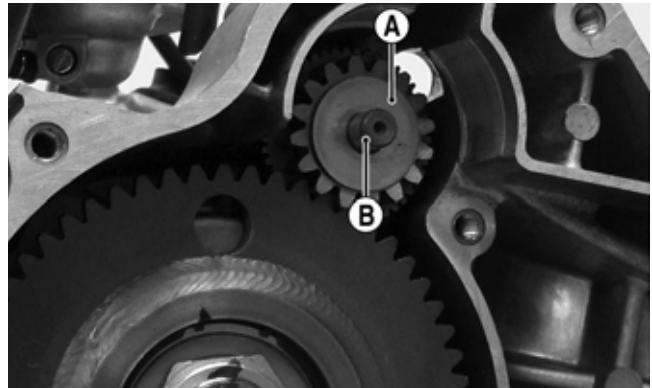

YT024A

■NOTE: The thrust washer and countershaft may come out with the countershaft housing.

- Remove the starter one-way nut using Starter One-Way Clutch Nut Wrench (p/n 0444-191); then install Starter One-Way Clutch Puller (p/n 0444-188) to the one-way housing.

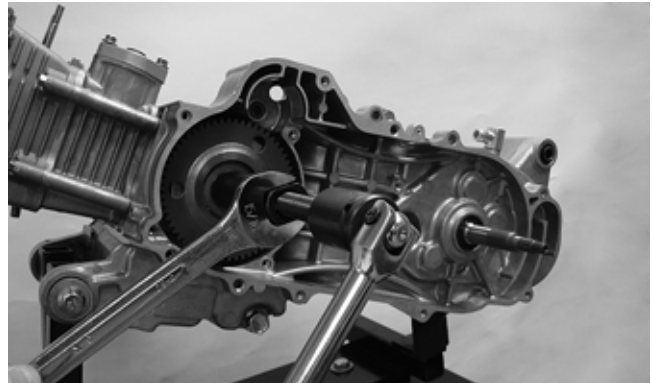

YT104

- Install the push-bolt into the puller; then using an appropriately sized wrench and breaker bar with socket as illustrated, tighten the push-bolt until the one-way clutch is free of the crankshaft.

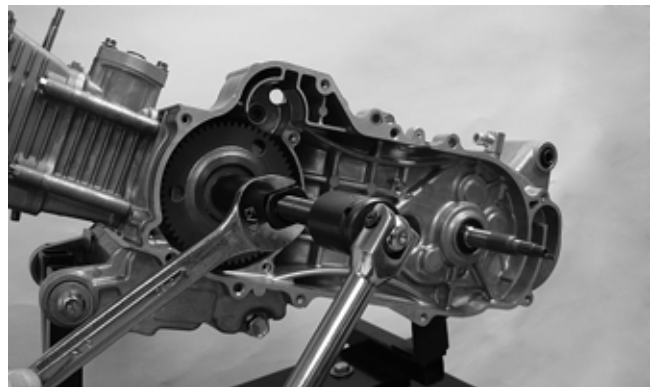

YT104

■NOTE: It may be necessary to strike the head of the bolt sharply with a hammer after tightening to free the one-way housing from the crankshaft.

- Make sure the transmission is in neutral; then remove the gear position switch noting the orientation of the drive pin. Account for an O-ring.



YT028

## Installing Left-Side Components

- A. GEAR POSITION SWITCH**
- B. STARTER ONE-WAY CLUTCH**
- C. ROTOR/FLYWHEEL**
- D. CENTRIFUGAL CLUTCH**
- E. V-BELT/DRIVE CLUTCH/DRIVEN PULLEY**

1. With the transmission in neutral, install a new O-ring on the gear position switch; then orient the pin as shown and install the switch into the gear case. Secure with a cap screw and tighten securely.



YT028

2. Secure the gear position switch wire as shown; then tighten the cap screw on the hold-down clip securely.

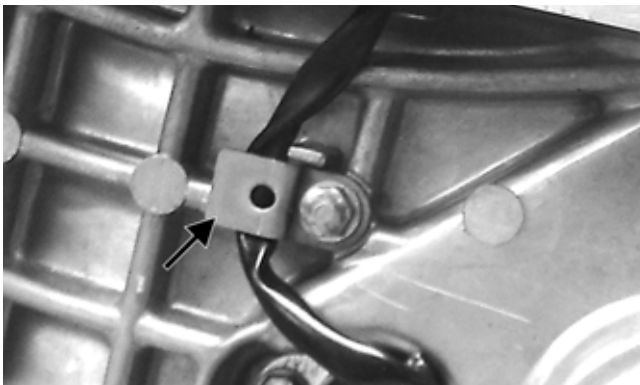

YT165A

3. Install the starter one-way clutch/gear assembly on the crankshaft; then with a thrust washer on each side of the starter countershaft gear, install the starter countershaft gear/countershaft into the crankcase.



YT024B

4. Install the starter countershaft housing; then install the starter one-way clutch cover. Tighten the cap screws securely.



YT023A

5. Install the driven pulley/centrifugal clutch assembly onto the transmission input shaft; then install the centrifugal clutch housing and secure with a flange nut (coated with red Loctite #271). Tighten to 40 ft-lb.

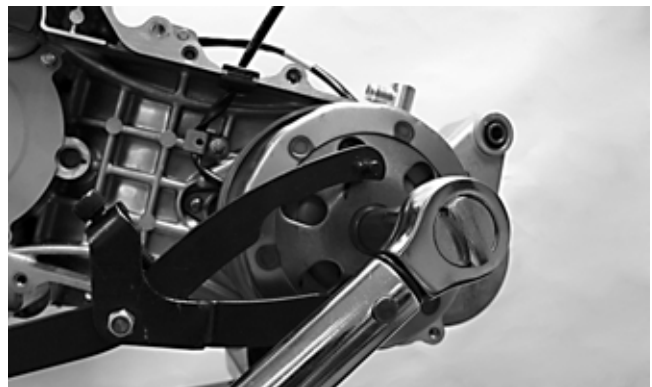

YT147

6. Install the movable drive face, bushing, and speed limiter spacer.

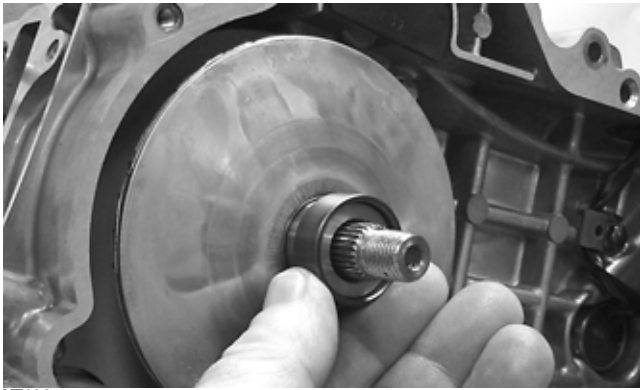

YT164

- Place the V-belt over the driven pulley; then over the bushing/spacer. Pinch the belt in the middle to draw it down into the driven pulley approximately 1 inch.

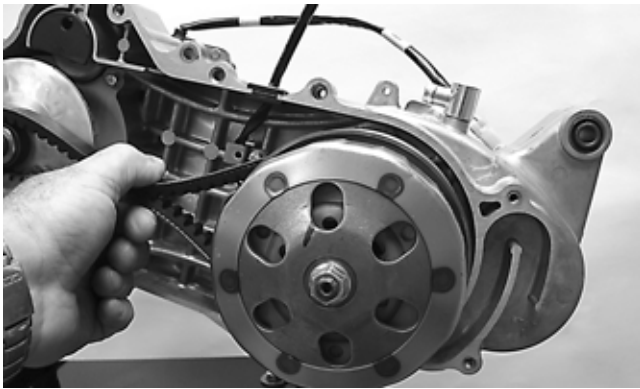

YT157

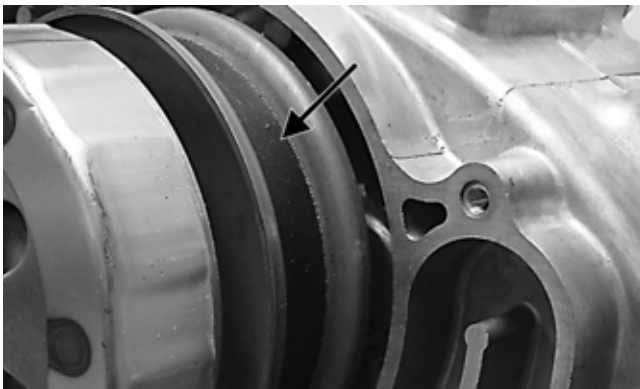

YT163A

- Install the fixed drive face onto the crankshaft and make sure sufficient splines are protruding to allow the kick-start ratchet to slide onto the splines; then install the ratchet (B) and secure with the flange nut (A) coated with red Loctite #271. Tighten to 27.5 ft-lb.

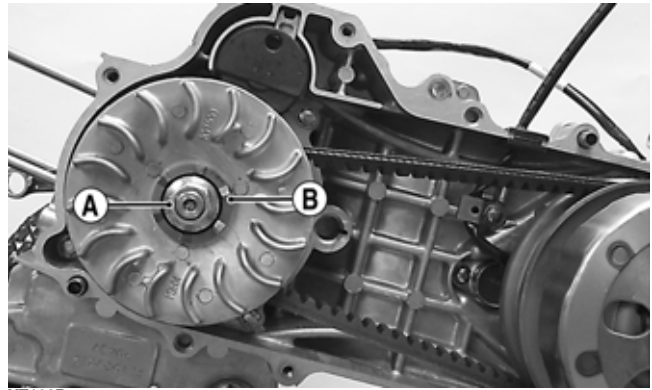

YT160B

### CAUTION

Failure to fully engage the splines with the kick-start ratchet could cause false torque reading and crankshaft damage.

- Install two alignment pins and the gasket; then secure the V-belt cover to the crankcase and tighten the cap screws in a crisscross pattern to 7 ft-lb. Make sure the different-length cap screw is located as illustrated.

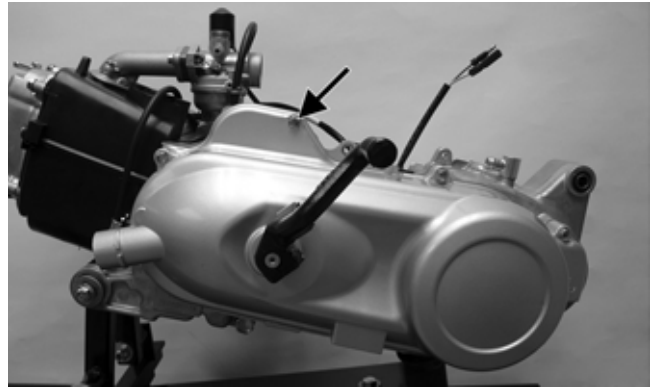

YT099A

## Right-Side Components

### ⚠ AT THIS POINT

To service center crankcase components only, proceed to Removing Right-Side Components.

■NOTE: For efficiency, it is preferable to remove and disassemble only those components which need to be addressed and to service only those components. The technician should use discretion and sound judgment.

### ⚠ AT THIS POINT

To service any one specific component, only limited disassembly of components may be necessary. Note the AT THIS POINT information in each sub-section.

■NOTE: The engine/transmission does not have to be removed from the frame for this procedure.

---

---

## Removing Right-Side Components

---

- A. COOLING FAN
- B. ROTOR/FLYWHEEL
- C. STATOR COIL
- D. OIL PUMP

1. Remove the intake pipe/carburetor. Account for an O-ring in the intake pipe.
2. Remove the cooling fan shroud; then remove the cooling shroud from the cylinder and cylinder head.



YT091A

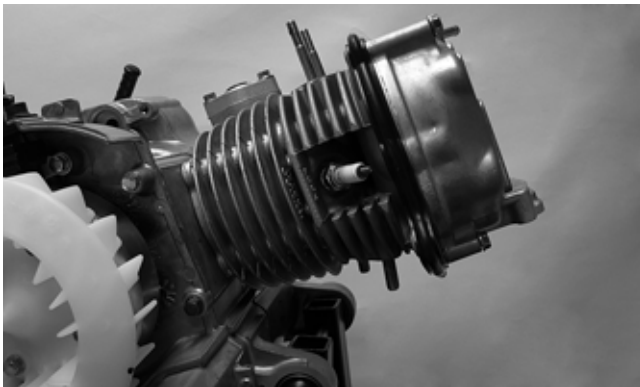

YT092

3. Remove the cooling fan; then remove the nut securing the rotor/flywheel.

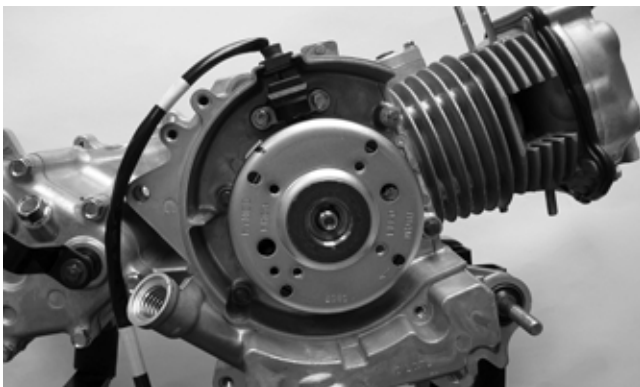

YT029

4. Remove the rotor/flywheel using the rotor/flywheel puller. Account for a key.

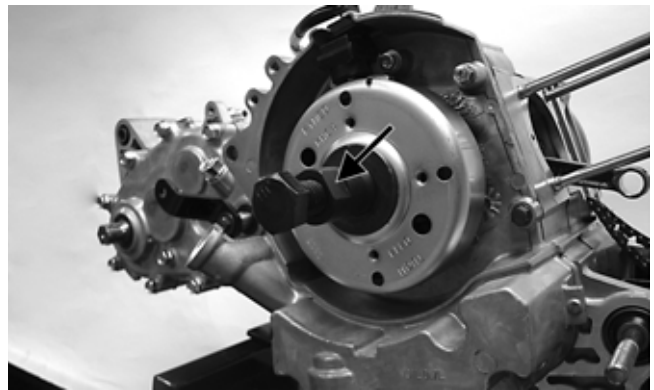

YT145A

5. Remove the stator coil/trigger coil assembly.

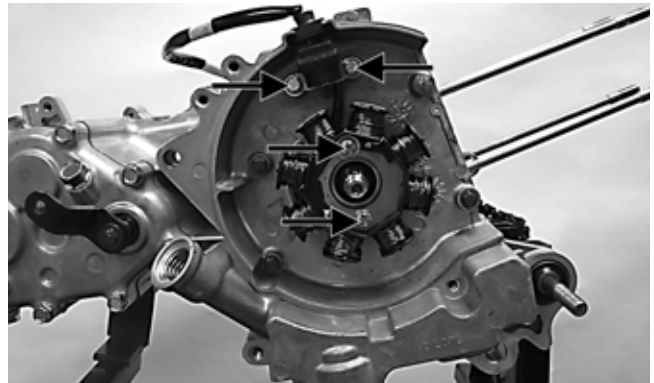

YT155A

6. Remove the five internal and three external cap screws securing the inner magneto housing to the crankcase; then remove the housing. Account for two alignment pins and a gasket.

■NOTE: Some engine oil will spill when the cap screws are loosened.

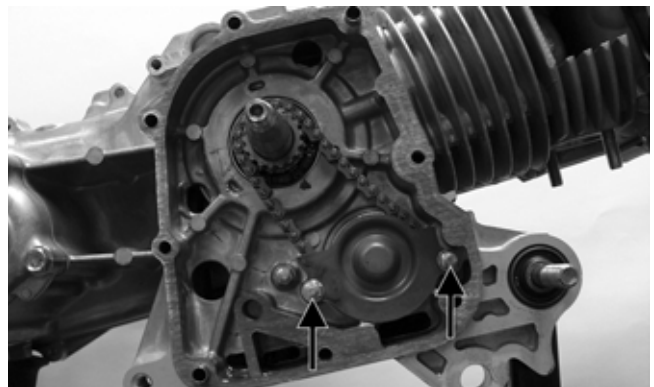

YT032A

7. Remove the oil pump baffle; then remove the nut from the oil pump shaft and remove the driven gear and drive chain.



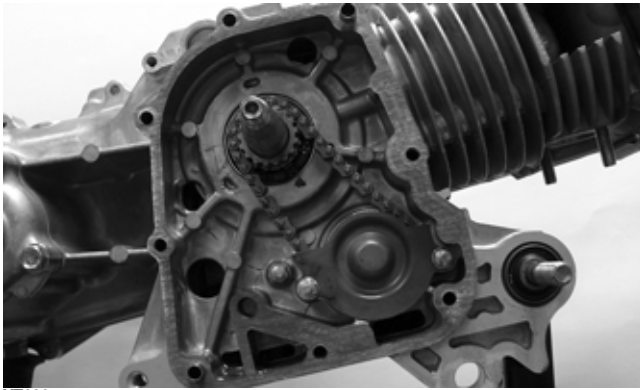

YT032

8. Remove the oil pump assembly being careful not to drop the oil pump driveshaft.



YT033

## E. TRANSMISSION

### Removing

1. Note the orientation of the shift arm for assembly; then remove the shift arm from the shift shaft.



YT035

2. Loosen the shift detent plug (A) approximately eight turns; then remove the cap screws securing the transmission case cover. Note the location of two longer cap screws (B).

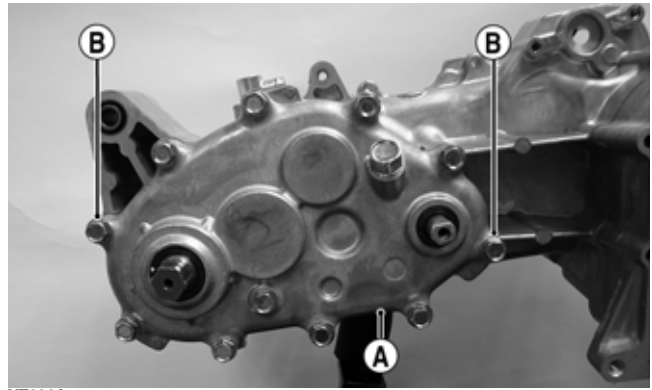

YT036A



YT220A

3. Carefully remove the transmission case cover while pressing in on the output driveshaft and shift shaft to leave components in the transmission case. Account for two alignment pins and gasket.



YT038



YT041A

■NOTE: The driveshaft thrust washer may be stuck to the cover. Make sure to install it on the driveshaft and keep together for assembly.



## Disassembling

■NOTE: For steps 4-8 refer to illustration YT041B.

4. Remove the output driveshaft (A); then remove the shift fork shaft (G).

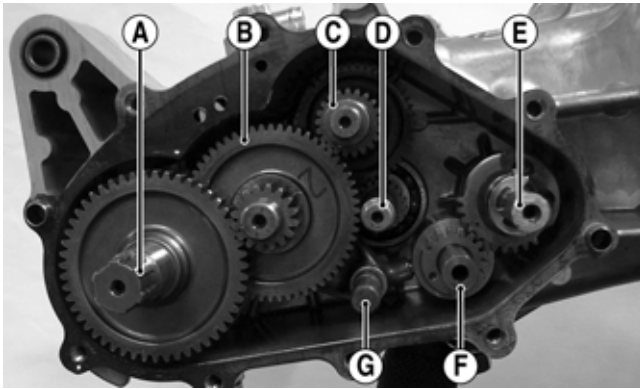

YT041B

5. Remove the main shaft (B) and shift fork together. Account for the shift fork, a spacer, and a thrust washer.



YT051

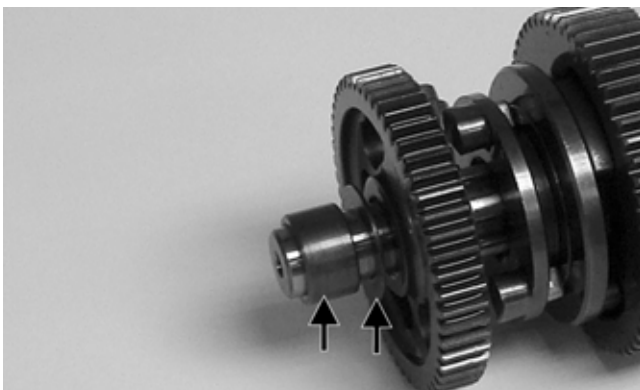

YT042A

6. Remove the countershaft (C). Account for one thrust washer.

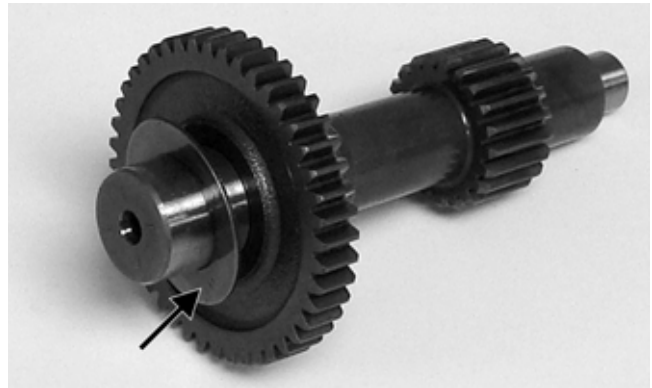

YT043A

7. Remove the shift shaft (E); then remove the shift cam/detent assembly (F).

8. Using a plastic mallet, drive the input driveshaft (D) and bearing from the transmission case.



YT037

## F. MAIN SHAFT

■NOTE: Unless absolutely necessary to replace components, do not disassemble the main shaft.

To disassemble the main shaft components, use the following procedure:

1. Remove the forward gear spacer and thrust washer; then remove the forward gear. Account for the forward gear bushing and washer.



YT063

---

---

## Servicing Right-Side Components

---

### TRANSMISSION COMPONENTS

1. Inspect all gears for chipping, excessive wear, flaking, or discoloration.

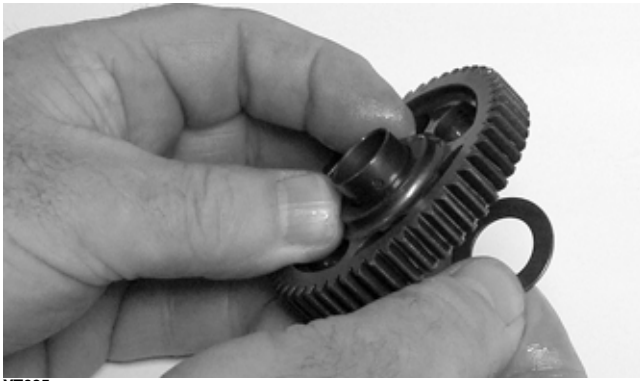

YT085

2. Remove the forward/reverse shift dog.

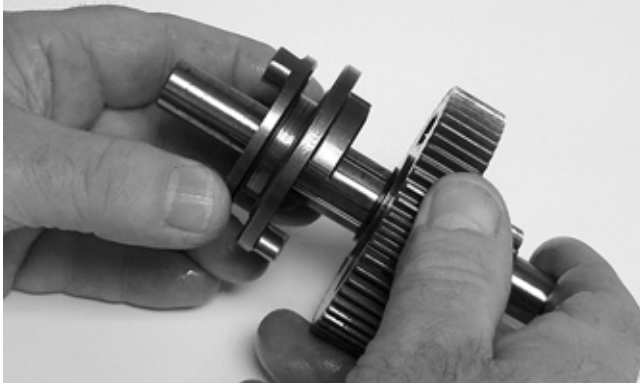

YT081

3. Remove the reverse gear snap ring and splined washer; then remove the reverse gear and thrust washer.



YT080



YT053

#### AT THIS POINT

The main shaft is now completely disassembled for inspection.

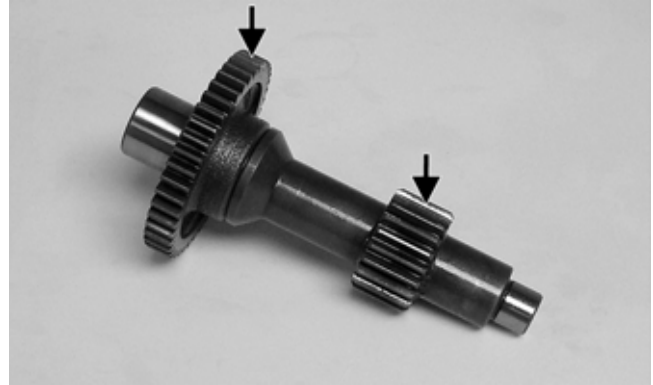

YT048A

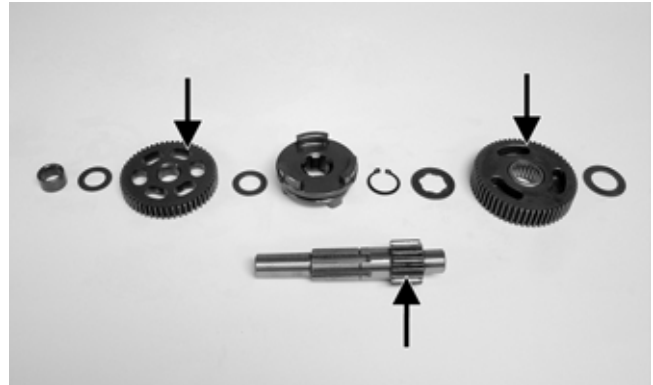

YT100A

2. Inspect the shift dog and mating gears for chipping, flaking, discoloration, or signs of excessive wear.



YT100B

3. Inspect all splined shafts for excessive spline wear, twisting, or discoloration.
4. Inspect the shift fork and shift dog mating surfaces for galling, discoloration, or excessive wear.
5. Inspect the shift shaft and shift cam/detent assembly for wear, chipping, or broken spring.
6. Rotate all bearings to check for roughness, discoloration, or looseness in the transmission case or cover.

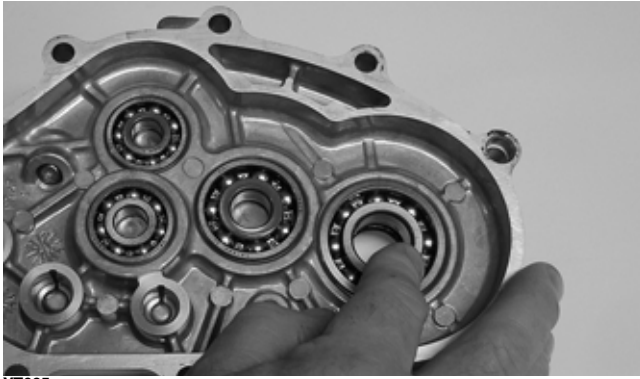

YT065

7. Inspect the detent spring and ball. Replace any worn or broken component.
8. Examine the transmission case and cover for cracks, discoloration, or chipped bearing bosses.

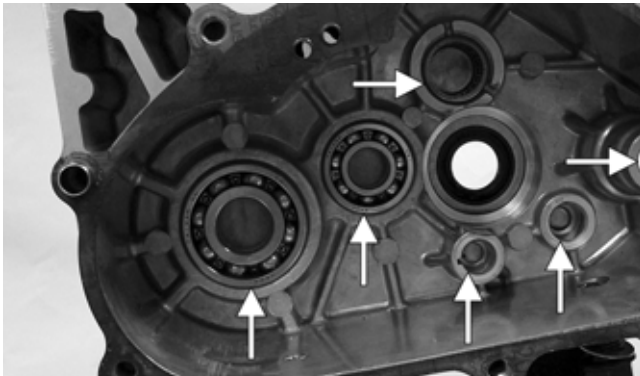

YT064B

### OIL PUMP

1. Inspect the pump for damage.
2. If the oil pump is damaged, it must be replaced.

■NOTE: The oil pump is a non-serviceable component and must be replaced as a complete assembly.

## Installing Right-Side Components

■NOTE: For steps 1-3, refer to illustration YT100C.

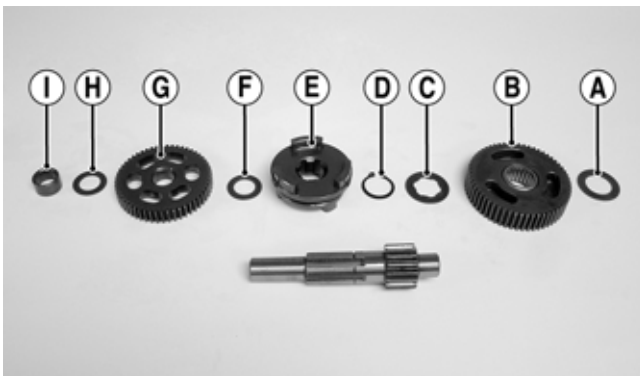

YT100C

### A. MAIN SHAFT

1. Install the non-splined reverse thrust washer (A) on the main shaft; then install the reverse gear (B) and splined thrust washer (C). Secure with the snap ring (D) pressing firmly toward the reverse gear to seat in the groove.



YT080

2. Install the forward/reverse shift dog (E), forward gear thrust washer (F), and forward gear bushing (G); then install the forward gear with the flat side toward the shift dog.

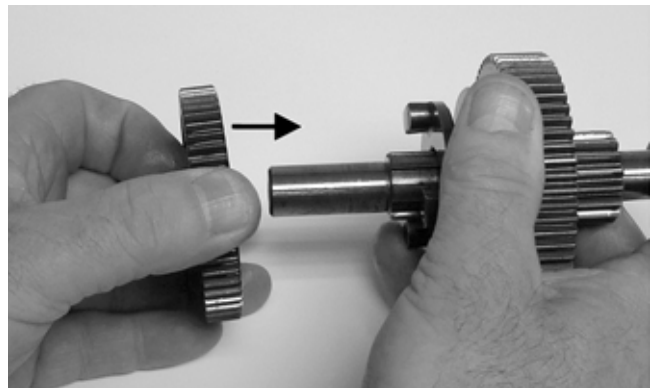

YT084A

3. Install the forward gear thrust washer (H) and the spacer (I).

#### 🔧 AT THIS POINT

The main shaft is now ready for installation into the transmission.

### B. TRANSMISSION

#### Assembling

1. Install new oil seals in the transmission case and cover; then coat the inner surfaces of the seals with multi-purpose grease.
2. Making sure the bearing is properly aligned in the transmission case, drive the input driveshaft and bearing into place with a plastic mallet.

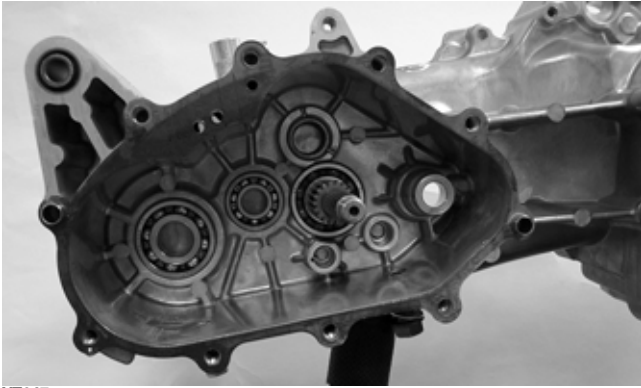

YT047

3. Install the countershaft with thrust washer into the transmission case.

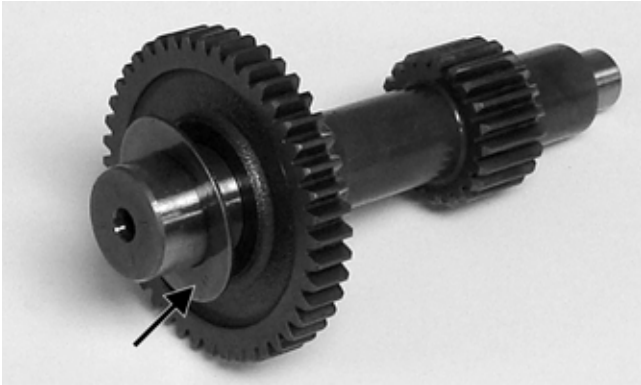

YT043A

4. Place the shift fork into position on the shift dog; then install the main shaft assembly into the transmission case with the shift fork oriented as shown. Make sure the spacer and thrust washer do not fall off the shaft.



YT072



YT083

5. Install the shift cam/detent assembly; then install the shift shaft aligning the timing index marks.

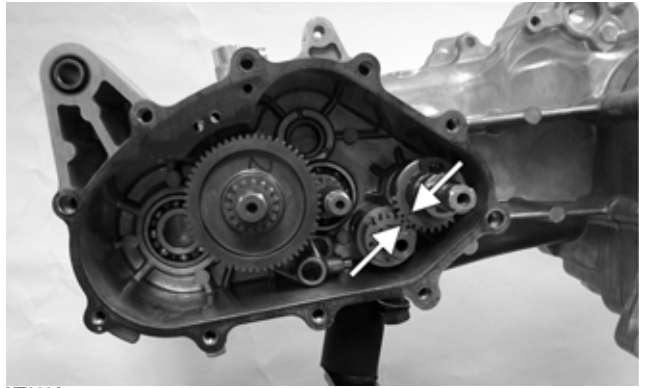

YT069A

6. Engage the shift fork into the shift cam/detent assembly; then secure with the shift fork shaft.

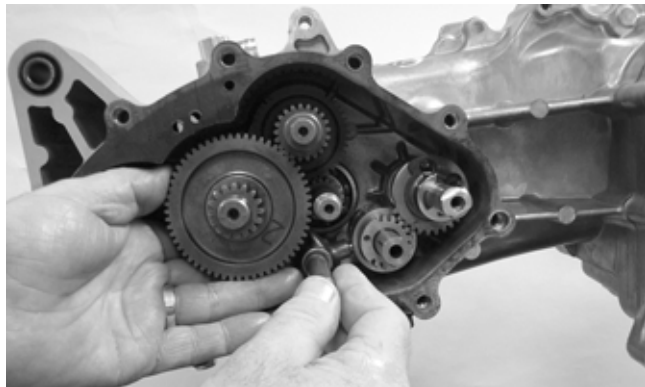

YT075

7. Install the output driveshaft; then install the thrust washer on the input driveshaft.



YT077

8. Place the alignment pins in the correct locations; then install a new gasket on the transmission case.



YT041A

9. Making sure the input driveshaft thrust washer is installed, carefully install the transmission case cover.

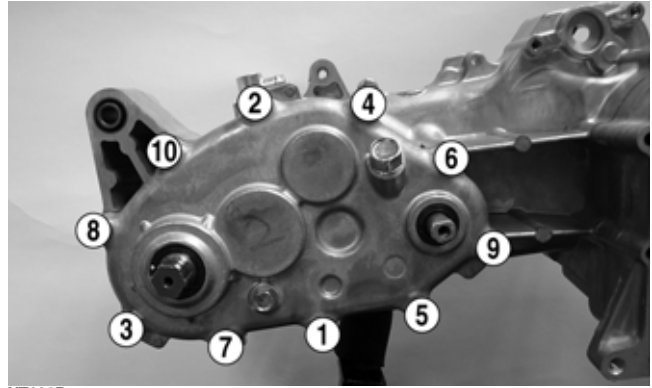

YT036B

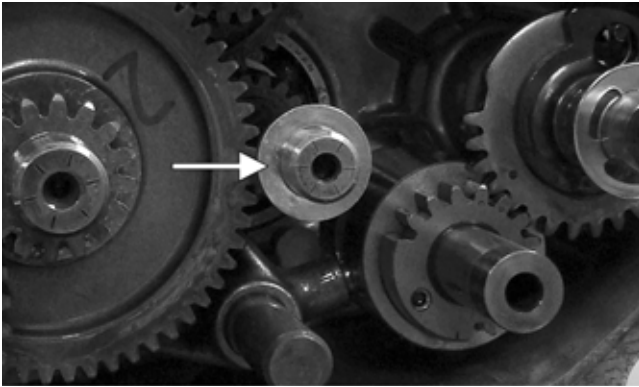

YT039A



YT220A

11. Install the shift arm on the shift shaft and secure with the cap screw. Tighten securely.



YT078



YT035

### CAUTION

Care must be taken to protect the lips of the shift shaft seal when installing the cover or seal damage may occur.

10. Secure the cover with the cap screws and tighten using the pattern shown to 22 ft-lb; then install the shift detent ball, spring, and plug and tighten securely.

## Center Crankcase Components

■NOTE: This procedure cannot be done with the engine/transmission in the frame. Complete Removing procedures for Top-Side, Left-Side, and Right-Side must precede this procedure.

■NOTE: For efficiency, it is preferable to remove and disassemble only those components which need to be addressed and to service only those components. The technician should use discretion and sound judgment.



---

---

## Disassembling Crankcase Halves

---

1. Remove one remaining cap screw from the right-side crankcase half; then tap the right-side crankcase half from the left side leaving the crankshaft in the left side. Account for a gasket and two alignment pins.

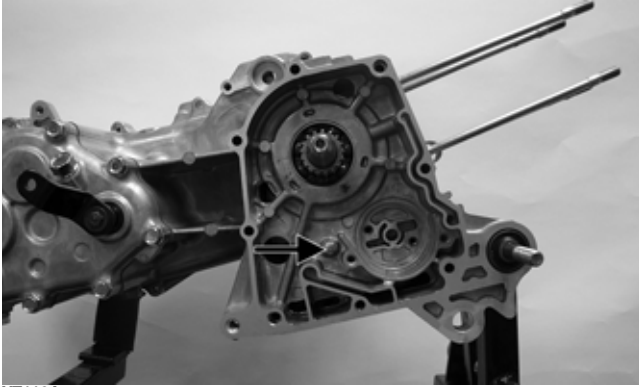

YT118A



YT119

2. Carefully remove the crankshaft from the left-side crankcase half while holding the timing chain clear of the timing sprocket; then remove the timing chain.



YT121



YT122

### AT THIS POINT

The center components are now disassembled for inspection.

---

## Servicing Crankcase Components

---

1. Inspect the crankshaft, crankshaft bearings, and connecting rod for excessive wear, damage, or discoloration.
2. Using a thickness gauge, check for the side-to-side clearance between the connecting rod and crankshaft. Clearance must not be greater than 0.05 mm.

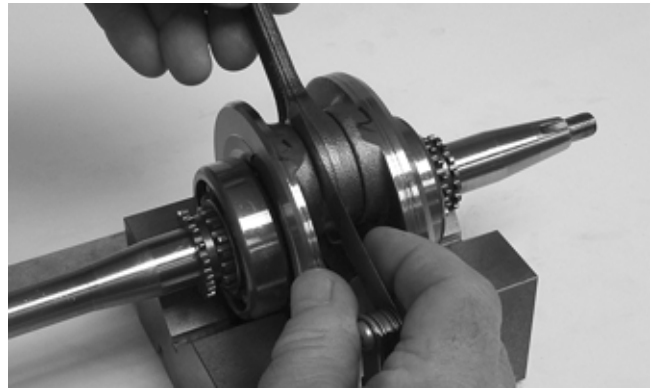

YT134

3. Place the crankshaft assembly on a set of V blocks; then using a dial indicator, measure crankshaft runout. Runout must not exceed 0.10 mm.

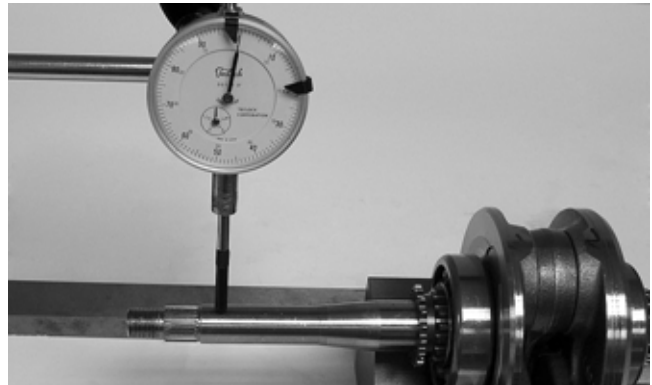

YT133

- Using an appropriate caliper, measure crankshaft web-to-web distance. Measurement must not exceed 45.15-45.20 mm.

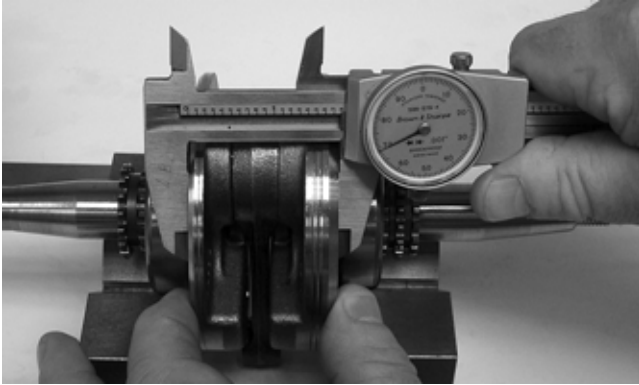

YT136

- Examine crankcase halves for discoloration in bearing bosses, cracks, or signs of warping.



YT122A

- Replace all oil seals with new seals and coat wear surfaces with clean, fresh grease.



YT153A



YT122B

## Assembling Crankcase Half

- Place the timing chain into the crankcase; then install the crankshaft assembly into the crankcase half.



YT120

- Install two alignment pins and a gasket; then install the right-side crankcase half. Secure with a cap screw (threads coated with red Loctite #271) and tighten to 8 ft-lb.

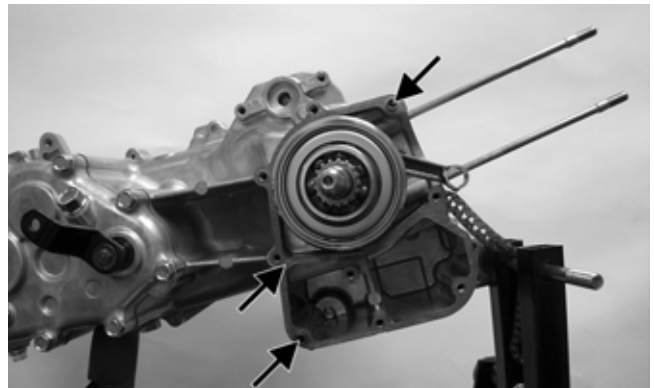

YT119A

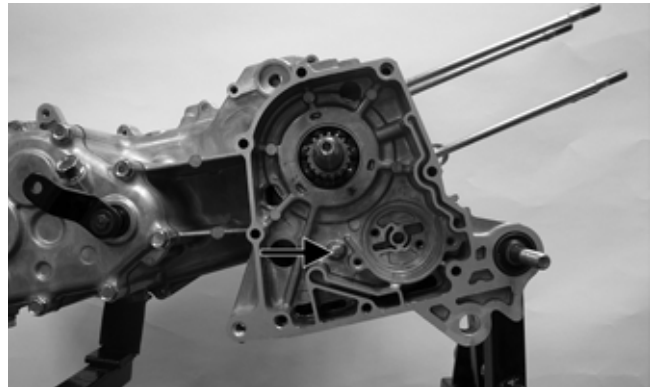

YT118A

- Install the oil pump into the crankcase with the arrow and dot directed upward; then secure with two cap screws and tighten to 7 ft-lb.

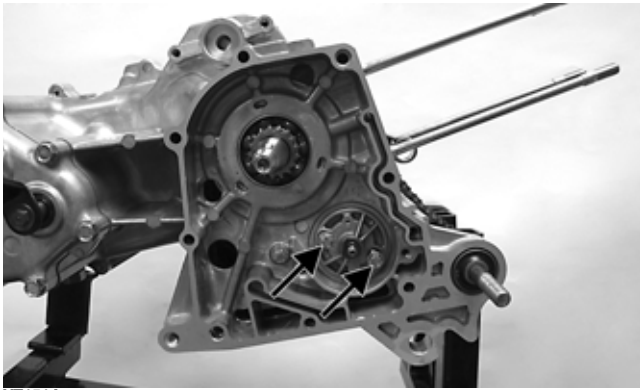

YT151A

4. Install the oil pump drive chain and driven gear and secure the gear to the pump shaft with the nut tightened to 7 ft-lb; then install the oil pump baffle and secure with the cap screws. Tighten securely.

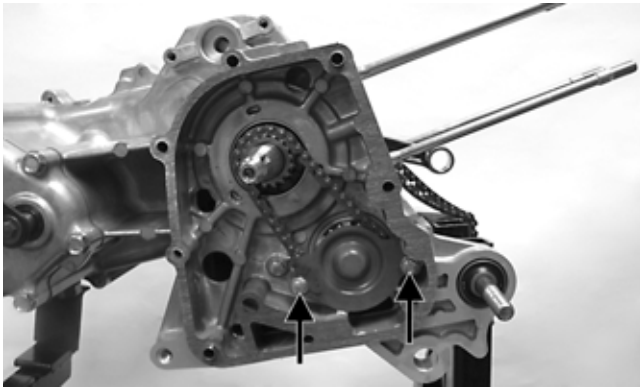

YT152A

5. Install the inner magneto housing using a new gasket making sure the alignment pins are correctly located; then secure with the five internal and three external cap screws.

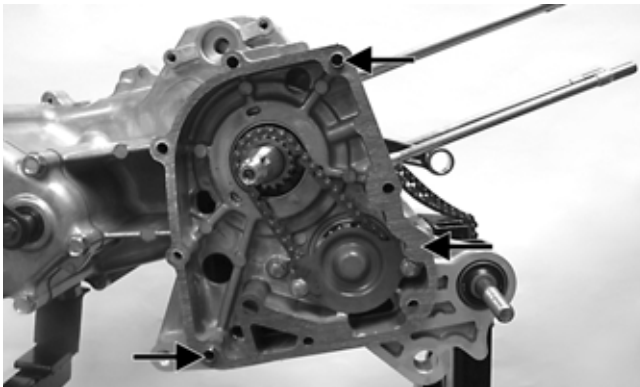

YT152B

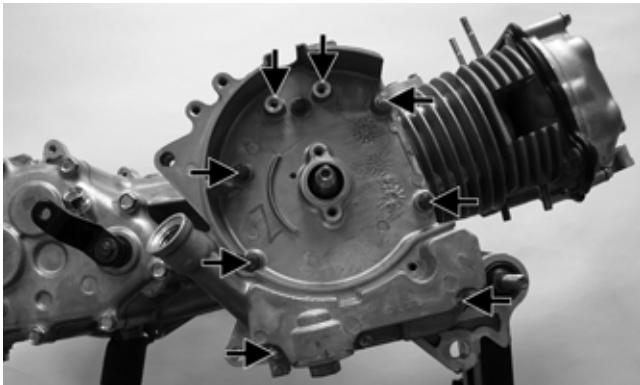

YT031A

6. Install the stator/trigger coil assembly and secure with four cap screws. Tighten securely.

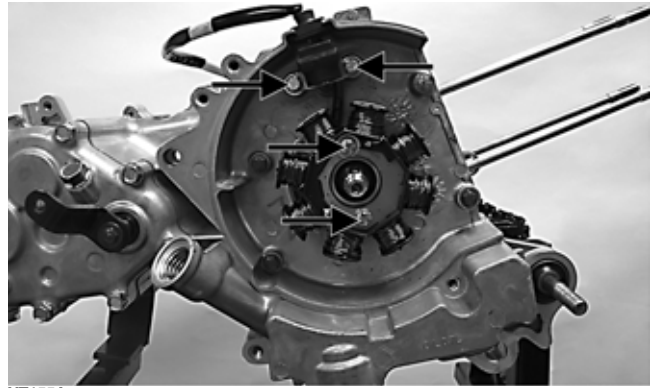

YT155A

7. Install the rotor flywheel making sure the crankshaft and flywheel bore are clean and free of any oil; then with the key in place, secure with the flywheel nut coated with red Loctite #271. Tighten to 30 ft-lb.



YT143

8. Install the cooling fan and secure with four cap screws; then install the fan shroud.

---

## Installing Engine/ Transmission

---

1. From the left side, place the engine/transmission into the frame tilting the top-side forward to clear the frame member.
2. Install the two front engine mounting brackets on the frame and tighten the cap screws securely; then install the two front through-bolts. Do not tighten at this time.

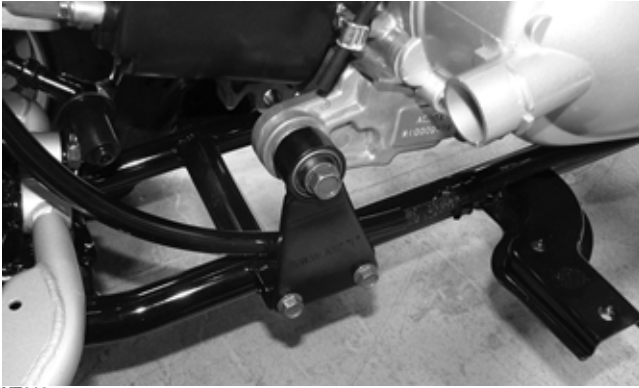

YT012

3. Install the rear engine mounting through-bolt and nut; then tighten the front and rear nuts to 32.5 ft-lb.
4. Install the drive sprocket and chain and secure with the spline-lock; then install the cap screws and tighten to 8 ft-lb.

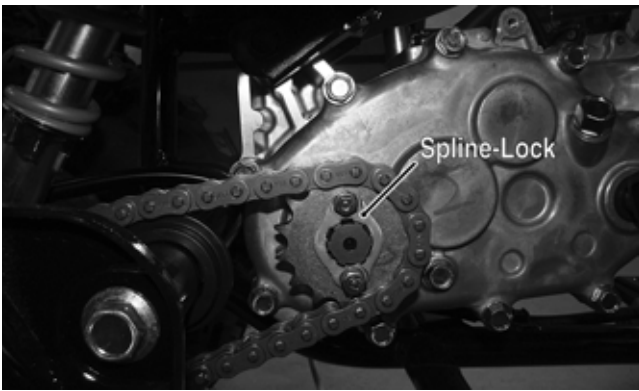

YT009A

5. Install the V-belt housing cooling duct and secure with the clamp; then install the exhaust pipe/muffler assembly using a new GRAFOIL seal in the cylinder head. Tighten the exhaust pipe to cylinder head nuts to 7 ft-lb and the muffler mounting cap screws to 32 ft-lb.

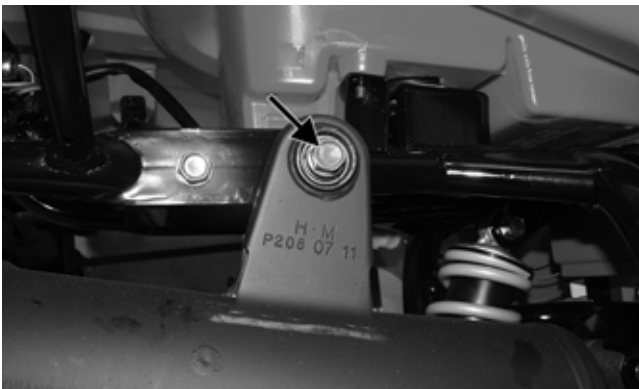

YT008A

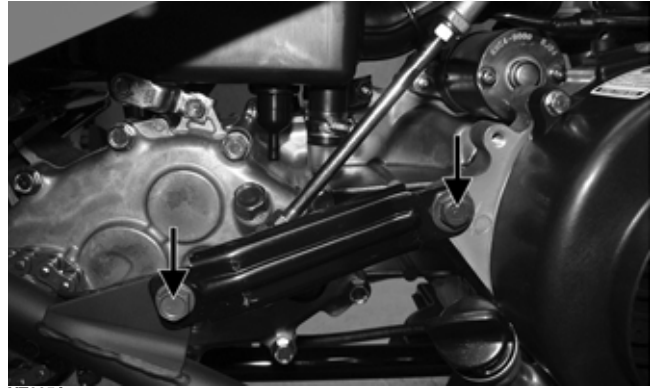

YT005A

6. With the O-rings installed, position the intake spacer and carburetor into place; then secure the carburetor to the manifold using the two cap screws.
7. Connect the large diameter AIS pump hose to the reed valve cover and the vacuum hose to the intake manifold.

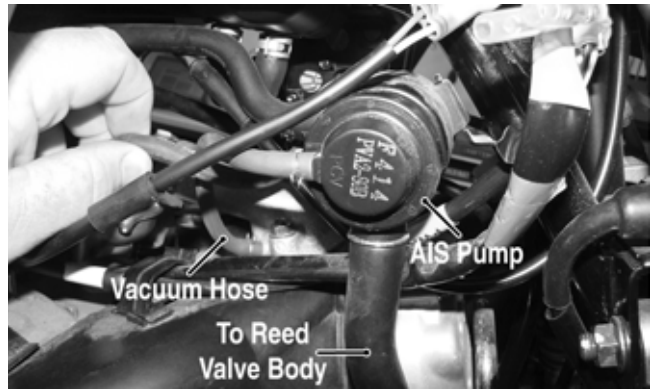

YT255A

8. Connect the shift linkage; then install the air filter housing and air filter. Tighten all hardware securely.



YT253

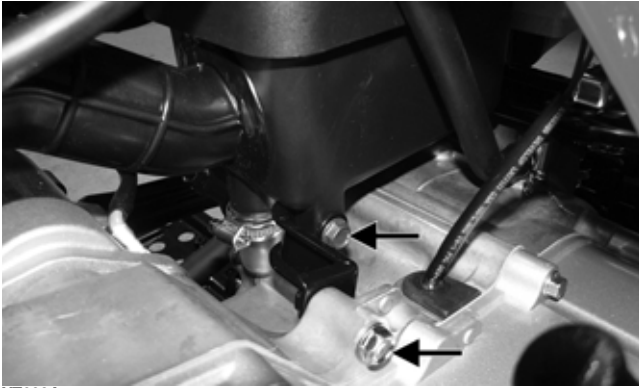

YT003A

9. Connect the starter harness connector (A), stator coil connector (B), and electric choke connector (C); then install the spark plug cap.

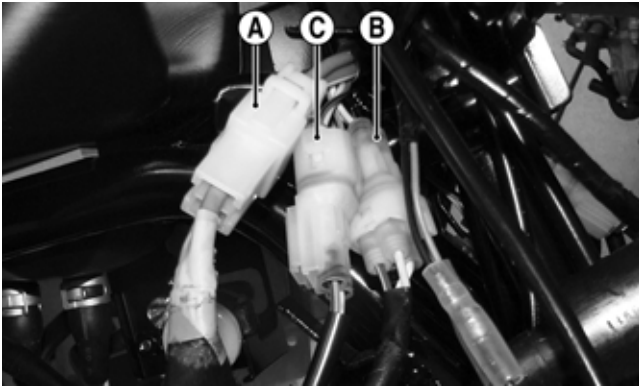

YT010A

10. Connect the fuel hose (A) to the carburetor; then connect the valve cover breather hose (B) to the air filter housing.

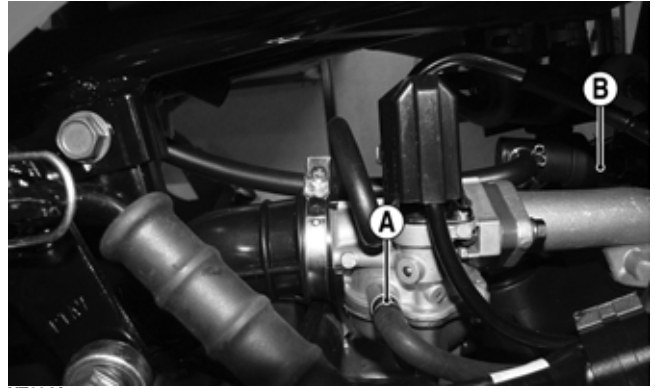

YT004A

11. Connect the gear shift position switch connectors to the main harness.

12. Install the left-side footwell mounting plate to the frame; then install the left and right footwells and secure to the mountings and fenders. Tighten all hardware securely.

13. Pour the recommended quantity of engine oil into the crankcase; then install the level stick and fill the transmission with the recommended amount of gear lubricant. Install the level plug and fill plug.

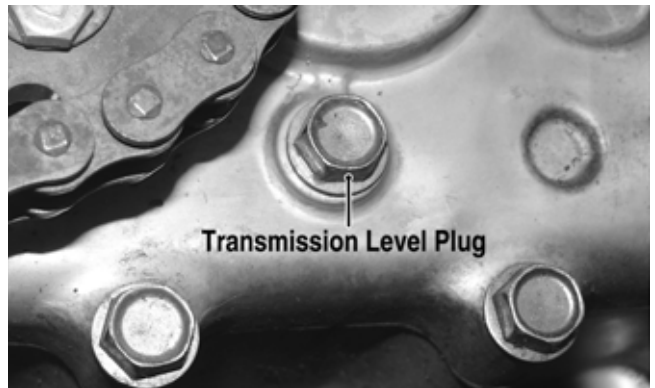

YT221A

14. Start the engine and check for any fluid leaks. After a short "test-ride," shut off the engine and check the fluid levels. Add fluids as required.



# Troubleshooting

Problem: Engine will not start or is hard to start (Compression too low)	
Condition	Remedy
<ol style="list-style-type: none"> <li>1. <b>Piston rings</b> worn excessively</li> <li>2. <b>Cylinder bore</b> worn</li> <li>3. <b>Spark plug</b> seating poorly</li> <li>4. <b>Starter motor</b> cranks too slowly — does not turn</li> <li>5. <b>Valves</b> burned — <b>tappets</b> adjusted too tight</li> </ol>	<ol style="list-style-type: none"> <li>1. Replace rings</li> <li>2. Replace — re-bore cylinder</li> <li>3. Tighten plug</li> <li>4. See Electrical System section</li> <li>5. Replace valves — adjust tappets</li> </ol>
Problem: Engine will not start or is hard to start (No spark)	
Condition	Remedy
<ol style="list-style-type: none"> <li>1. <b>Spark plug</b> fouled</li> <li>2. <b>Spark plug</b> wet</li> <li>3. <b>Magneto</b> defective</li> <li>4. <b>CDI unit</b> defective</li> <li>5. <b>Ignition coil</b> defective</li> <li>6. <b>High-tension lead</b> open — shorted</li> </ol>	<ol style="list-style-type: none"> <li>1. Clean — replace plug</li> <li>2. Clean — dry plug</li> <li>3. Replace magneto</li> <li>4. Replace CDI unit</li> <li>5. Replace ignition coil</li> <li>6. Replace high tension lead</li> </ol>
Problem: Engine will not start or is hard to start (No fuel reaching the carburetor)	
Condition	Remedy
<ol style="list-style-type: none"> <li>1. <b>Gas tank vent hose</b> obstructed</li> <li>2. <b>Carburetor inlet needle</b> defective</li> <li>3. <b>Fuel hose</b> obstructed</li> <li>4. <b>Fuel screens</b> obstructed</li> </ol>	<ol style="list-style-type: none"> <li>1. Clean vent hose</li> <li>2. Replace needle</li> <li>3. Clean — replace hose</li> <li>4. Clean — replace inlet screen — valve screen</li> </ol>
Problem: Engine stalls easily	
Condition	Remedy
<ol style="list-style-type: none"> <li>1. <b>Spark plug</b> fouled</li> <li>2. <b>Magneto</b> defective</li> <li>3. <b>CDI unit</b> defective</li> <li>4. <b>Carburetor jets</b> obstructed</li> </ol>	<ol style="list-style-type: none"> <li>1. Clean plug</li> <li>2. Replace magneto</li> <li>3. Replace CDI unit</li> <li>4. Clean jets</li> </ol>
Problem: Engine noisy (Noise seems to come from piston)	
Condition	Remedy
<ol style="list-style-type: none"> <li>1. <b>Piston — cylinder</b> worn</li> <li>2. <b>Combustion chamber</b> carbon buildup</li> <li>3. <b>Piston pin — piston pin bore</b> worn</li> <li>4. <b>Piston rings — ring groove(s)</b> worn</li> </ol>	<ol style="list-style-type: none"> <li>1. Replace — service piston — cylinder</li> <li>2. Clean chamber</li> <li>3. Replace — service pin — bore</li> <li>4. Replace rings — piston</li> </ol>
Problem: Engine noisy (Noise seems to come from clutch)	
Condition	Remedy
<ol style="list-style-type: none"> <li>1. <b>Clutch shoe(s)</b> worn</li> <li>2. <b>Driven clutch hub</b> warped — worn</li> </ol>	<ol style="list-style-type: none"> <li>1. Replace clutch shoe(s)</li> <li>2. Replace clutch</li> </ol>
Problem: Engine noisy (Noise seems to come from crankshaft)	
Condition	Remedy
<ol style="list-style-type: none"> <li>1. <b>Bearing</b> worn — burned</li> <li>2. <b>Lower rod-end bearing</b> worn — burned</li> <li>3. <b>Connecting rod side clearance</b> too large</li> <li>4. <b>Engine oil</b> low — incorrect grade</li> </ol>	<ol style="list-style-type: none"> <li>1. Replace bearing</li> <li>2. Replace bearing</li> <li>3. Replace thrust washer(s)</li> <li>4. Fill crankcase with recommended engine oil</li> </ol>
Problem: Engine idles poorly	
Condition	Remedy
<ol style="list-style-type: none"> <li>1. <b>Magneto</b> defective</li> <li>2. <b>CDI unit</b> defective</li> <li>3. <b>Spark plug</b> fouled — <b>gap</b> too wide</li> <li>4. <b>Ignition coil</b> defective</li> <li>5. <b>Float level</b> out of adjustment</li> <li>6. <b>Carburetor jets</b> obstructed</li> <li>7. <b>Pilot screw setting</b> improper</li> </ol>	<ol style="list-style-type: none"> <li>1. Replace magneto</li> <li>2. Replace CDI unit</li> <li>3. Adjust gap — replace plug</li> <li>4. Replace ignition coil</li> <li>5. Adjust float height</li> <li>6. Clean jets</li> <li>7. Adjust pilot screw</li> </ol>
Problem: Engine runs poorly at high speed	
Condition	Remedy
<ol style="list-style-type: none"> <li>1. <b>Spark plug gap</b> too narrow</li> <li>2. <b>Ignition coil</b> defective</li> <li>3. <b>Float level</b> too low</li> <li>4. <b>Air cleaner element</b> obstructed</li> <li>5. <b>Fuel hose</b> obstructed</li> <li>6. <b>Carburetor jets</b> obstructed</li> <li>7. <b>Air filter inlet pipe</b> obstructed</li> </ol>	<ol style="list-style-type: none"> <li>1. Adjust gap</li> <li>2. Replace ignition coil</li> <li>3. Adjust float arm height</li> <li>4. Clean element</li> <li>5. Clean — prime hose</li> <li>6. Clean jets</li> <li>7. Remove obstruction</li> </ol>

<b>Problem: Exhaust smoke dirty or heavy</b>	
<b>Condition</b>	<b>Remedy</b>
<ol style="list-style-type: none"> <li>1. <b>Piston rings</b> — cylinder worn</li> <li>2. <b>Cylinder wall</b> scored — scuffed</li> <li>3. <b>Crankcase</b> over-full of oil</li> <li>4. <b>Air filter</b> too much air filter element oil</li> <li>5. <b>Carburetor jets</b> incorrect size (too big)</li> </ol>	<ol style="list-style-type: none"> <li>1. Replace — service rings — cylinder</li> <li>2. Replace — service cylinder</li> <li>3. Drain excess oil from crankcase — recheck oil level</li> <li>4. Use recommended type and quantity air filter element oil</li> <li>5. Use recommended carburetor jets</li> </ol>
<b>Problem: Engine lacks power</b>	
<b>Condition</b>	<b>Remedy</b>
<ol style="list-style-type: none"> <li>1. <b>Piston ring(s)</b> — cylinder worn</li> <li>2. <b>Spark plug</b> fouled</li> <li>3. <b>Spark plug gap</b> incorrect</li> <li>4. <b>Carburetor jets</b> obstructed</li> <li>5. <b>Float level</b> out of adjustment</li> <li>6. <b>Air filter element</b> obstructed</li> <li>7. <b>Intake manifold</b> leaking air</li> <li>8. <b>Brake(s)</b> dragging</li> <li>9. <b>Drive axle</b> bent — worn bearings</li> <li>10. <b>Drive chain</b> — sprockets stretched — worn</li> </ol>	<ol style="list-style-type: none"> <li>1. Replace — service rings — cylinder</li> <li>2. Clean — replace plug</li> <li>3. Adjust gap — replace plug</li> <li>4. Clean jets</li> <li>5. Adjust float arm height</li> <li>6. Clean element</li> <li>7. Tighten — replace manifold</li> <li>8. Adjust brake(s)</li> <li>9. Straighten — replace axle</li> <li>10. Replace sprocket — chain</li> </ol>
<b>Problem: Engine overheats</b>	
<b>Condition</b>	<b>Remedy</b>
<ol style="list-style-type: none"> <li>1. <b>Carbon deposit (piston crown)</b> excessive</li> <li>2. <b>Engine oil</b> low</li> <li>3. <b>Octane</b> low — gasoline poor</li> <li>4. <b>Oil pump</b> defective</li> <li>5. <b>Oil filter/screen</b> obstructed</li> <li>6. <b>Float level</b> low</li> <li>7. <b>Intake manifold</b> leaking air</li> <li>8. <b>Air filter element</b> obstructed</li> </ol>	<ol style="list-style-type: none"> <li>1. Clean piston</li> <li>2. Add engine oil</li> <li>3. Drain — replace gasoline</li> <li>4. Replace pump</li> <li>5. Clean filter/screen</li> <li>6. Adjust float arm height</li> <li>7. Tighten — replace manifold</li> <li>8. Clean element</li> </ol>

---

---

## Fuel/Lubrication

---

This section has been organized for servicing the fuel system. The technician should use discretion and sound judgment when removing/disassembling and assembling/installing components.

**⚠ WARNING**

Whenever any maintenance or inspection is made on a fuel system when there may be fuel leakage, there should be no welding, smoking, open flames, etc., in the area.

---

---

### Carburetor

---

#### REMOVING

1. Turn the gas tank valve to the OFF position; then disconnect the gas hose from the carburetor.



CD590

2. Disconnect the float chamber drain hose and the vent hose from the carburetor.
3. Loosen the air intake boot clamp.



YT260

4. Remove the cap screws securing the carburetor to the intake manifold; then remove the carburetor. Account for the spacer and O-rings.

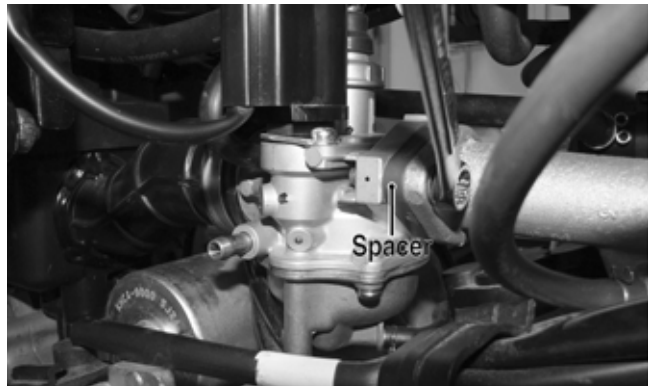

YT261A

5. Unscrew the carburetor cap; then lift the cap removing the throttle valve, spring, and jet needle. Account for a gasket, a needle clip plate, and a needle clip.

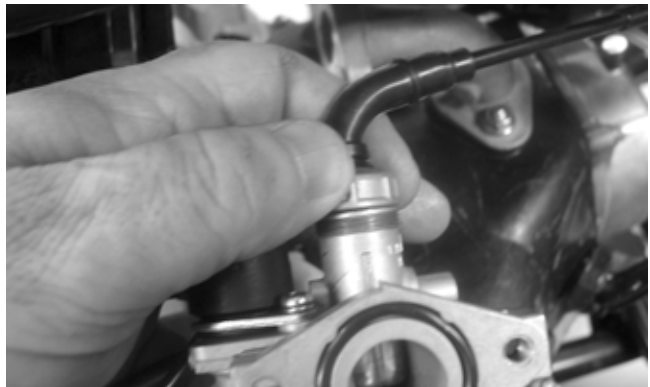

CD594

6. Disconnect the choke assembly connector; then remove the carburetor.



YT222

#### DISASSEMBLING

1. Remove the two Phillips-head screws securing the choke assembly; then remove the assembly. Account for the washers and the O-ring.
2. Remove the Phillips-head screws securing the float chamber; then remove the chamber. Account for the seal and the washers.



CD600

3. Remove the float pin; then lift the float with needle valve from the carburetor body.



CD605

6. Remove the slow jet.

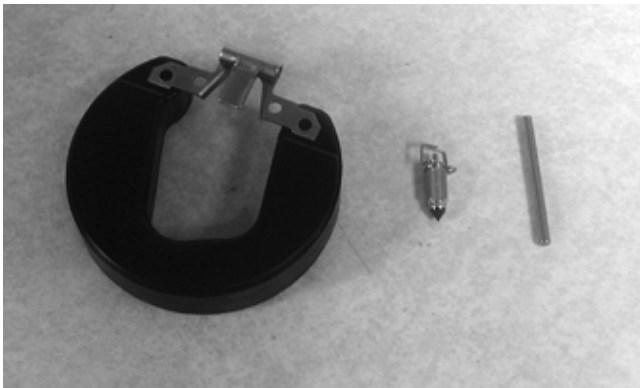

CD603

4. Remove the idle adjustment screw assembly. Account for a spring.

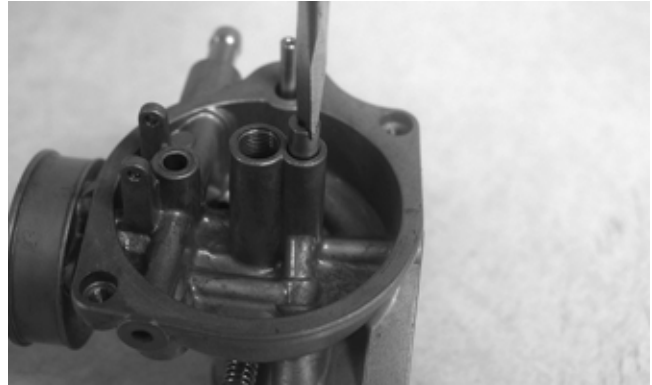

CD606

## CLEANING AND INSPECTING

### **⚠ WARNING**

When drying components with compressed air, always wear safety glasses.

### **CAUTION**

DO NOT place any non-metallic components in parts-cleaning solvent because damage or deterioration will result.



CD610

5. Remove the jet holder; then remove the main jet from the jet holder.

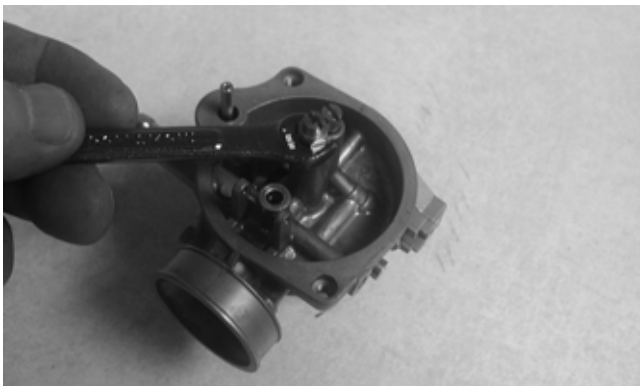

CD604

1. Place all metallic components in a wire basket and submerge in carburetor cleaner.
2. Soak for 30 minutes; then rinse with fresh parts-cleaning solvent.
3. Wash all non-metallic components with soap and water. Rinse thoroughly.
4. Dry all components with compressed air only making sure all holes, orifices, and channels are unobstructed.
5. Inspect the carburetor body for cracks, nicks, stripped threads, and any other imperfections in the casting.
6. Inspect float for damage.
7. Inspect gasket, seal, and O-rings for distortion, tears, or noticeable damage.
8. Inspect tips of the jet needle, pilot screw, and the needle valve for wear, damage, or distortion.
9. Inspect the slow jet and main jet for obstructions or damage.

■NOTE: If the slow jet is obstructed, the mixture will be extremely lean at idle and part-throttle operation.

10. Inspect the choke assembly for wear or damage.

## ASSEMBLING

1. Install the slow jet.

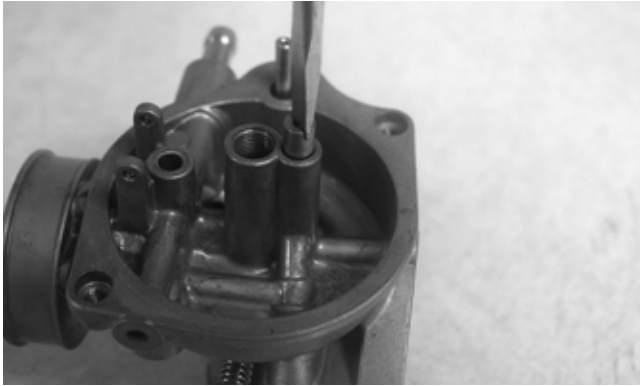

CD606

2. Install the main jet by threading it into the jet holder; then install the jet holder into the carburetor. Tighten both components securely.

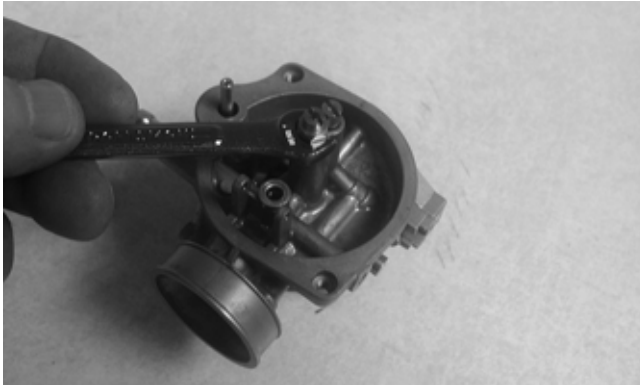

CD604

3. Install the idle adjustment screw with the spring.

■NOTE: Turn the idle adjustment screw clockwise until lightly seated; then turn it counterclockwise 2-1/2 turns out.

4. Install the float and needle valve assembly into the carburetor; then install the float pin.



CD763

■NOTE: Check float height by inverting the carburetor freeing the float arm; then measure with a ruler the height when the float arm is in contact with the needle valve. Float height should be 10.2 mm (0.40 in.). To adjust, bend the actuator arm tab.

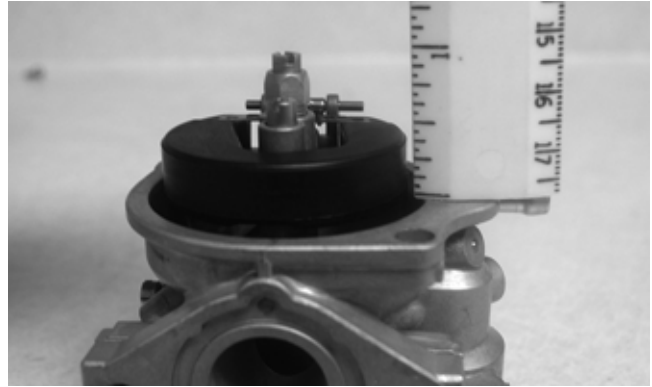

CD615

5. Install the float chamber seal.



CD601

6. Place the float chamber into position making sure the seal is properly seated; then secure with the Phillips-head screws and washers.



CD600

7. Install the choke assembly. Tighten the two Phillips-head screws (with washers) securely.



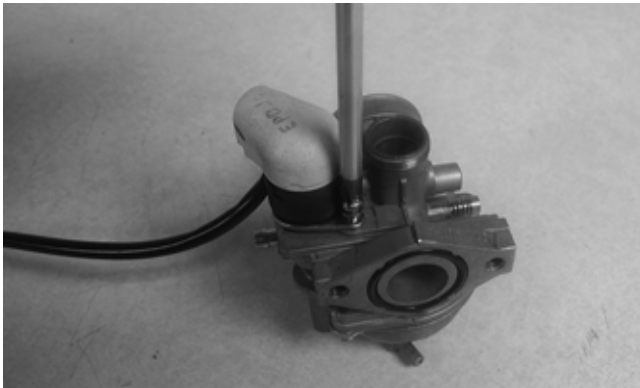

CD598

8. Insert the throttle cable into the top of the cap assembly and through the spring.
9. Compress the spring to expose the end of the throttle cable; then hook the end of the cable into the throttle valve. Release tension on the spring to hold the throttle cable.

### INSTALLING

1. Install the throttle valve into the carburetor with the machined groove engaging the guide pin; then install the jet needle, needle clip, needle clip plate, and gasket.
2. Thread the carburetor cap onto the carburetor; then tighten securely.

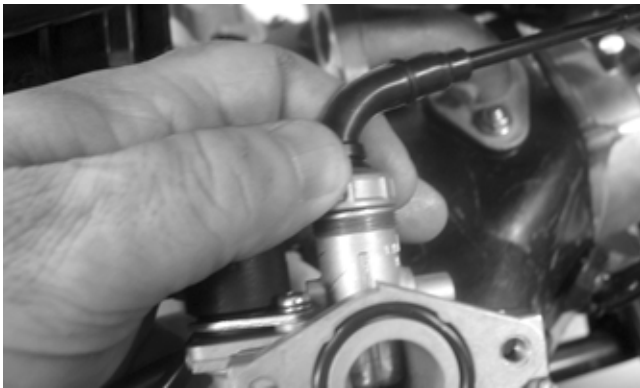

CD594

3. Connect the choke assembly connector.



YT222

4. Install the carburetor onto the intake manifold; then tighten the cap screws securely.

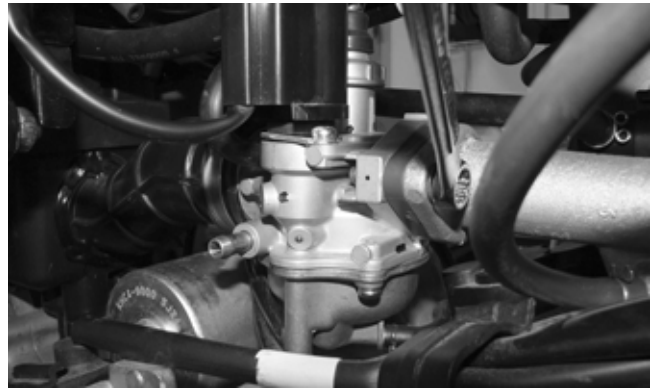

YT261

5. Install the air intake boot between the air filter and the carburetor. Secure with the clamp.



YT260

6. Install the float chamber drain hose and the vent hose to the carburetor.
7. Install the gas hose onto the carburetor.

---

## Throttle Cable Free-Play

---

To adjust the throttle cable free-play, use the following procedure:

1. Pull back rubber boot to access cable adjustment nut.



KM071A

2. Loosen jam nut to allow cable adjustment nut to be adjusted.
3. Turn cable adjustment nut clockwise to increase free-play in the cable. Turn the adjustment nut counterclockwise to decrease free-play in the cable.

- There should be approximately 6 mm (0.25 in.) free-play in the cable.
- Tighten the jam nut to secure the adjustment; then slide the rubber boot back into position.

---

## Engine RPM (Idle)

---

■NOTE: To properly adjust the idle RPM, a tachometer is necessary.

- Set the brake lever locks. Start the engine and warm it up to normal operating temperature.

### CAUTION

Make sure the engine is fully warm before adjusting the idle RPM.

- Turn the idle adjustment screw in or out until the engine idles at 1700 RPM. Turning the screw clockwise will increase RPM; turning counterclockwise will decrease RPM.



YT015B

---

## Gas Tank

---

### ⚠ WARNING

Whenever any maintenance or inspection is made on the fuel system during which there may be fuel leakage, there should be no welding, smoking, open flames, etc., in the area.

### REMOVING

- Turn the gas tank valve to the OFF position.
- Remove the gas hose from the carburetor by removing the spring clamp; then funnel the gas hose into an appropriate container of sufficient size to catch all the gas from the gas tank.
- Turn the gas tank valve to the RES position and drain the gas from the gas tank.
- Remove the main body panel (see Steering/Body/Controls — Body).
- Remove the gas hoses from the gas tank valve.

■NOTE: Mark the gas hoses for assembling purposes.



YT229

- Remove the two cap screws securing the gas tank; then remove gas tank from vehicle.

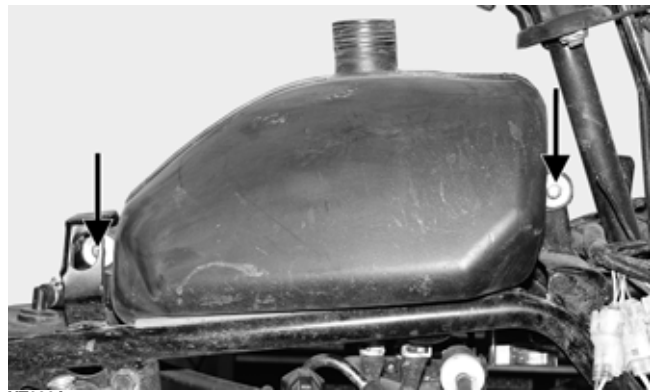

YT230A

### CLEANING AND INSPECTING

- Clean all gas tank components with parts-cleaning solvent.
- Inspect all hoses for cracks or leaks.
- Inspect gas tank cap and tank for leaks, holes, and damaged threads.

### INSTALLING

- Place the gas tank into position on the frame; then install the gas hoses to the gas tank valve on the frame according to the marks made during removing.



YT229

2. Install and tighten the gas tank cap screws securely.

### CAUTION

Do not over-tighten the cap screws securing the gas tank.

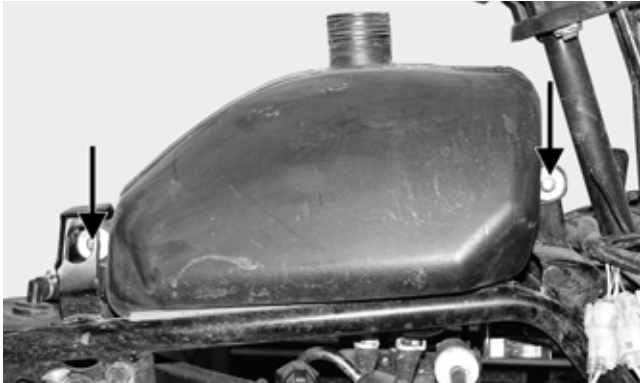

YT230A

3. Install the main body panel (see Steering/Body/Controls — Body).

---

## Gas Tank Valve

---

This ATV has a valve mounted on the side of the frame separate from the gas tank. There are three positions: ON, RES, and OFF.

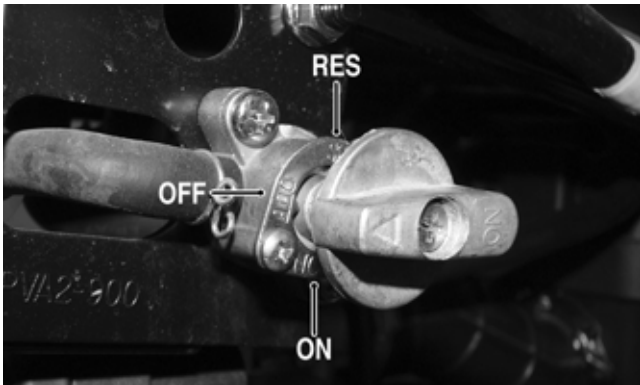

YT251A

In the OFF position, the valve will not allow gasoline to flow to the carburetor. In the ON position (the normal operating position), gasoline will flow from the tank to the carburetor. In this position, 1.3 L (0.34 U.S. gal.) of gasoline will remain in the tank as a reserve quantity. Moving the valve to the RES position will allow the operator to use the remaining gasoline in the tank. When turning the valve to any of the three positions, be sure the indicator is pointed directly at the position desired.

### REMOVING/INSPECTING

#### ⚠ WARNING

Drain the gas tank prior to this procedure.

1. Remove the cap screws securing the valve to the frame; then pull the valve out far enough to gain access to the three gas hoses (two to the gas tank, one to the carburetor).
2. Remove the gas hoses from the valve by releasing the spring clamps.
3. Inspect for and remove any obstructions in the valve.

### INSTALLING

1. Install the gas hoses onto the valve with the spring clamps.
2. Place the valve into position on the frame and secure with the cap screws. Tighten securely.

---



---

## Troubleshooting

---

<b>Problem: Starting impaired</b>	
<b>Condition</b>	<b>Remedy</b>
1. <b>Carburetor</b> leaking air 2. <b>Choke</b> not operating properly	1. Tighten — adjust carburetor — replace gasket 2. Check choke assembly
<b>Problem: Idling or low speed impaired</b>	
<b>Condition</b>	<b>Remedy</b>
1. <b>Slow jet</b> obstructed — loose 2. <b>Needle jet</b> obstructed 3. <b>Pilot screw setting</b> incorrect 4. <b>Float level</b> incorrect	1. Clean — tighten jet 2. Clean jet 3. Adjust pilot screw 4. Adjust float arm height
<b>Problem: Medium or high speed impaired</b>	
<b>Condition</b>	<b>Remedy</b>
1. <b>Main jet</b> obstructed 2. <b>Needle jet</b> obstructed 3. <b>Throttle valve</b> not operating properly 4. <b>Filter</b> obstructed 5. <b>Float level</b> incorrect	1. Clean main jet 2. Clean needle jet 3. Check throttle valve operation 4. Clean filter 5. Adjust float arm height
<b>Problem: Overflow and fuel level fluctuations</b>	
<b>Condition</b>	<b>Remedy</b>
1. <b>Needle valve</b> worn — damaged — dirty 2. <b>Float</b> not working properly 3. <b>Float level</b> too high — too low	1. Clean — replace needle valve 2. Adjust float arm height — replace float 3. Adjust float arm height

---

---

## Electrical System

---

The electrical connections should be checked periodically for proper function. In case of an electrical failure, check fuse, connections (for tightness, corrosion, damage), and/or bulb.

Each time the ATV is used, switches should be checked for proper operation. Use the following list for reference:

- A. Ignition switch — engine will start (with brake lever compressed).
- B. Emergency stop switch — engine will stop.
- C. Brake light switch — brake light will illuminate with brake lever(s) compressed.

### Testing Electrical Components

All of the electrical tests should be made using the Fluke Model 77 Multimeter. If any other type of meter is used, readings may vary due to internal circuitry. When troubleshooting a specific component, always verify first the fuse is good, the bulb is good, the connections are clean and tight, the battery is fully charged, and all appropriate switches are activated.

■NOTE: For absolute accuracy, all tests should be made at room temperature (approximately 68° F).

---

---

## Battery

---

The battery is located under the seat.

After being in service, batteries require regular cleaning and recharging in order to deliver peak performance and maximum service life. The following procedure is recommended for cleaning and maintaining a sealed battery. Always read and follow instructions provided with battery chargers and battery products.

■NOTE: Refer to all warnings and cautions provided with the battery or battery maintainer/charger.

Loss of battery charge may be caused by ambient temperature, ignition OFF current draw, corroded terminals, self discharge, frequent start/stops, and short engine run times. Extended low RPM operation, short trips, and high amperage accessory usage are also reasons for battery discharge.

### Maintenance Charging

■NOTE: Use the CTEK Multi US 800 or the CTEK Multi US 3300 for battery maintenance charging. Maintenance charging is required on all batteries not used for more than two weeks or as required by battery drain.



800A

1. When charging a battery in the vehicle, be sure the ignition switch is in the OFF position.
2. Clean the battery terminals with a solution of baking soda and water.

■NOTE: The sealing strip should NOT be removed and NO fluid should be added.

3. Be sure the charger and battery are in a well-ventilated area. Be sure the charger is unplugged from the 110-volt electrical outlet.
4. Connect the red terminal lead from the charger to the positive terminal of the battery; then connect the black terminal lead of the charger to the negative terminal of the battery.

■NOTE: Optional battery charging adapters are available from your authorized dealer to connect directly to your vehicle from the recommended chargers to simplify the maintenance charging process. Check with your authorized dealer for proper installation of these charging adapter connectors.

5. Plug the battery charger into a 110-volt electrical outlet.
6. If using the CTEK Multi US 800, there are no further buttons to push. If using the CTEK Multi US 3300, press the Mode button (A) at the left of the charger until the Maintenance Charge Icon (B) at the bottom illuminates. The Normal Charge Indicator (C) should illuminate on the upper portion of the battery charger.

■NOTE: The maintainer/charger will charge the battery to 95% capacity at which time the Maintenance Charge Indicator (D) will illuminate and the maintainer/charger will change to pulse/float maintenance. If the battery falls below 12.9 DC volts, the charger will automatically start again at the first step of the charge sequence.



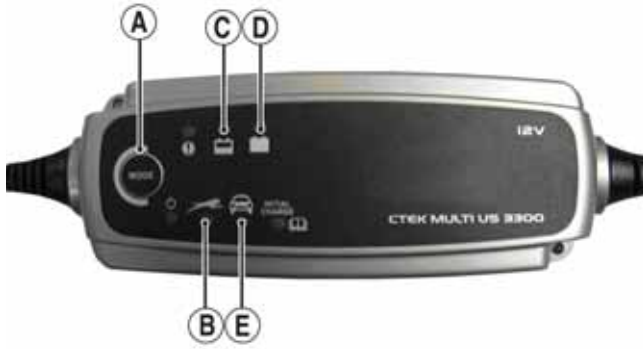

3300C

■NOTE: Not using a battery charger with the proper float maintenance will damage the battery if connected over extended periods.

### Charging

■NOTE: Use the CTEK Multi US 800 or the CTEK Multi US 3300 for battery maintenance charging.

1. Be sure the battery and terminals have been cleaned with a baking soda and water solution.

■NOTE: The sealing strip should NOT be removed and NO fluid should be added.

2. Be sure the charger and battery are in a well-ventilated area. Be sure the charger is unplugged from the 110-volt electrical outlet.
3. Connect the red terminal lead from the charger to the positive terminal of the battery; then connect the black terminal lead of the charger to the negative terminal of the battery.
4. Plug the charger into a 110-volt electrical outlet.
5. By pushing the Mode button (A) on the left side of the charger, select the Normal Charge Icon (E). The Normal Charge Indicator (C) should illuminate on the upper left portion of the charger.
6. The battery will charge to 95% of its capacity at which time the Maintenance Charge Indicator (D) will illuminate.

■NOTE: For optimal charge and performance, leave the charger connected to the battery for a minimum 1 hour after the Maintenance Charge Indicator (D) illuminates. If the battery becomes hot to the touch, stop charging. Resume after it has cooled.

7. Once the battery has reached full charge, unplug the charger from the 110-volt electrical outlet.

■NOTE: If, after charging, the battery does not perform to operator expectations, bring the battery to an authorized dealer for further troubleshooting.

---



---

## Ignition Switch

---

The connector is accessible below the front fender panel in front of the steering post.

## VOLTAGE

■NOTE: Perform this test on the harness side of the connector.

1. Set the meter selector to the DC Voltage position.
2. Connect the red meter lead to the red wire; then connect the black meter lead to a suitable ground.
3. Meter must read battery voltage.

■NOTE: If the meter reads no battery voltage, troubleshoot the battery, fuse, or the main wiring harness.

## RESISTANCE

### CAUTION

Always disconnect the battery when performing resistance tests to avoid damaging the multimeter.

■NOTE: Perform this test on the switch side of the connector.

1. Turn the ignition switch to the ON position.
2. Set the meter selector to the OHMS position.
3. Connect the red tester lead to the red wire; then connect the black tester lead to the black wire.
4. The meter must read less than 1 ohm.
5. With the switch in the OFF position, connect the red tester lead to the green wire and the black tester lead to the black/white wire. The meter must read an open circuit on both wires.

■NOTE: If the meter reads more than 1 ohm of resistance, troubleshoot or replace the switch/ component, the connector, or the switch wiring harness.

---



---

## Ignition Coil

---

The ignition coil is attached to the frame above the front right shock absorber.

### CAUTION

Always disconnect the battery when performing resistance tests to avoid damaging the multimeter.

■NOTE: For these tests, the meter selector should be set to the OHMS position.

## PRIMARY WINDING RESISTANCE

1. Disconnect the black/yellow and green wires from the coil.
2. Connect the red tester lead to one terminal; then connect the black tester lead to the other terminal.
3. The meter must read less than 1 ohm.

■NOTE: If the meter does not read as specified, replace ignition coil.

## PRIMARY VOLTAGE

1. Set the meter to DCV. Disconnect the black/yellow wire and green wire from the ignition coil; then turn the ignition switch to the ON position.

2. Connect the black meter lead to the black/yellow wire and the red meter lead to the green wire.
3. The reading must show approximately battery voltage.

### SECONDARY WINDING RESISTANCE

1. Remove both primary wires.
2. Connect the red tester lead to the high tension lead (plug cap removed); then connect the black tester lead to either primary lead.
3. The meter must read 2830-3170 ohms.

■NOTE: If the meter does not read as specified, replace the ignition coil.

### SECONDARY VOLTAGE

1. Remove the spark plug cap from the spark plug.
2. Connect the spark plug cap to Ignition Test Plug or other suitable tool; then ground the tool away from the spark plug hole. While turning the engine over, check for sufficient spark.

### SPARK PLUG CAP RESISTANCE

1. Connect the red tester lead to one end of the cap; then connect the black tester lead to the other end of the cap.
2. The meter must read 4725-5775 ohms.

■NOTE: If the meter does not read as specified, replace the spark plug cap.

## Ignition Timing

The ignition timing cannot be adjusted; however, verifying ignition timing can aid in troubleshooting other components. To verify ignition timing, use the following procedure:

1. Attach a timing light to the spark plug high tension lead; then remove the right footwell and the right-side fan cover.
2. Using a tachometer, start the engine and run at 1800 RPM; ignition timing should be 13° BTDC ("F" mark).
3. Install the fan cover and right footwell.

If ignition timing cannot be verified, the rotor may be damaged, the key may be sheared, the trigger coil bracket may be bent or damaged, or the CDI unit may be faulty.

## Handlebar Control Switches

The connector is in front of the steering post. The connector is accessible beneath the front fender.

■NOTE: These tests should be made on the switch side of the connector.

### CAUTION

Always disconnect the battery when performing resistance tests to avoid damaging the multimeter.

### RESISTANCE (Starter Button)

1. Set the meter selector to the OHMS position.
2. Connect the red tester lead to the yellow/red wire; then connect the black tester lead to the green wire.
3. With the starter button depressed, the meter must read less than 1 ohm.
4. With the starter button released, the meter must read an open circuit.

■NOTE: If the meter does not read as specified, replace the switch/component, connector, or switch harness.

### RESISTANCE (Emergency Stop)

1. Set the meter selector to the OHMS position.
2. Connect the red tester lead to the blue/yellow wire; then connect the black tester lead to the green wire.
3. With the switch in the OFF position, the meter must read an open circuit.
4. With the switch in the RUN position, the meter must read less than 1 ohm.

■NOTE: If the meter reads more than 1 ohm of resistance, troubleshoot or replace the switch/component, the connector, or the switch wiring harness.

## Brake Light Switches

The left brake switch can be tested at the handlebar. The right brake switch connector is located under the right front fender.

■NOTE: The ignition switch must be in the ON position.

### VOLTAGE (Wiring Harness Connector)

1. Set the meter selector to the DC Voltage position; then turn the ignition switch to the ON position.
2. Connect the red tester lead to the black wire; then connect the black tester lead to a suitable ground.
3. The meter must read battery voltage.

■NOTE: If the meter reads no battery voltage, troubleshoot the battery, fuse, switch, or the main wiring harness.

■NOTE: If the meter reads battery voltage, the main wiring harness is good; test the switch/component, the connector, and the switch wiring harness for resistance.

## RESISTANCE (Brake Light Switch Connectors)

### CAUTION

Always disconnect the battery when performing resistance tests to avoid damaging the multimeter.

■NOTE: The brake lever must be compressed for this test. Also, the ignition switch must be in the OFF position. Disconnect the switches.

1. Set the meter selector to the OHMS position.
2. Connect the red tester lead to the black wire; then connect the black tester lead to the green/yellow wire.
3. When the lever is compressed, the meter must read less than 1 ohm.

■NOTE: If the meter reads more than 1 ohm of resistance, troubleshoot or replace the switch/component, the connector, or the switch wiring harness.

---

---

## Headlights

---

The two-pin white connectors are located under the front fender assembly.

### BULB VERIFICATION

Visually inspect the bulb for broken filaments, blackening, or loose bulb base.

### VOLTAGE

■NOTE: Perform this test on the main harness side of the connectors. The engine must be running for this test.

1. Set the meter to the AC Voltage position.
2. Connect the black tester lead to one side of the connector and the red tester lead to the other side.
3. With the engine running, the meter must show 9.0-13.5 AC volts.

■NOTE: If the meter shows no voltage, inspect wiring harness or connectors. If normal, perform a stator coil test.

■NOTE: The resistor is mounted to the frame on the left side of the vehicle above the CVT housing.

### LIGHTING RELAY RESISTOR

1. Set the meter to Ohms.
2. Disconnect the resistor from the main harness.
3. Place the red meter lead to the green/black wire and the black meter lead to a suitable ground.
4. The meter should read approximately 10.2 ohms.

---

---

## Stator Coil

---

Disconnect the three-wire connector in front of the steering post; then insert a jumper wire to connect the timing sensor to the harness (blue/yellow wire).

### VOLTAGE (No Load)

1. Set the meter selector to the AC Voltage position.
2. Connect the red tester lead to the white wire; then connect the black tester lead to a suitable ground.
3. With the transmission in neutral, start the engine and run at 3000 RPM or to the RPM limiter. The meter must read 13.5-16.5 AC volts.

### RESISTANCE

1. Set the meter selector to the OHMS position.
2. Connect the red tester lead to the yellow wire; then connect the black tester lead to a suitable ground.
3. The meter must read less than 1 ohm.
4. Move the red test lead to the white wire. The meter must read approximately 1 ohm.

---

---

## Regulator/Rectifier

---

The regulator/rectifier is located near the front left top shock mount.

### VOLTAGE

1. Set the meter selector to the DC Voltage position.
2. Connect the red tester lead to the red wire and the black tester lead to the green wire (with the regulator/rectifier plugged in).
3. With the engine running at a constant 3000 RPM, the meter must read 12.1-15.2 DC volts.

---

---

## Timing Sensor

---

Disconnect the three-wire connector next to the steering post.

### VOLTAGE

Set the meter to VAC. Connect the timing sensor connector; then connect the red tester lead to the blue/yellow wire and the black tester lead to a suitable ground. At idle, the meter will read approximately 0.35 VAC and should increase up to 0.7 VAC as RPM is increased.

### RESISTANCE

1. Set the meter selector to the OHMS position.
2. Connect the red tester lead to the blue/yellow wire; then connect the black tester lead to a suitable ground.
3. The meter must read 80-160 ohms.

---

---

## Starter Motor

---

■NOTE: The starter motor is not a serviceable component. If the motor is defective, it must be replaced.

### REMOVING

1. Disconnect the battery.

<b>CAUTION</b>
----------------

Always disconnect the negative battery cable from the battery first; then disconnect the positive cable.
--

2. Remove the starter motor from the engine (see Engine/Transmission).
3. Remove the nut securing the positive cable to the starter; then remove the cable from the starter. Account for an O-ring.

### INSTALLING

Install the starter motor (see Engine/Transmission).

---

---

## Choke Circuit

---

Disconnect the white two-pin connector adjacent to the steering post.

### VOLTAGE

■NOTE: The battery must be at full charge for this test.

1. Set the meter selector to the AC Voltage position.

2. Connect the red tester lead to the yellow wire; then connect the black tester lead to the green/black wire.
  3. Crank the engine over using the electric starter. The meter must read 3.5-4.5 AC volts.
- 
- 

## Fuse

---

The main (7 amp) fuse is located on the frame near the battery under the seat.

■NOTE: To remove the fuse, separate the fuse case and lift out.

If there is any type of electrical system failure, always check the fuse first.

<b>CAUTION</b>
----------------

Always replace a blown fuse with a fuse of the same type and rating.
--

<b>CAUTION</b>
----------------

Always disconnect the battery when performing resistance tests to avoid damaging the multimeter.
--

1. Set the meter selector to the OHMS position.
2. Connect the red tester lead to one end of the fuse; then connect the black tester lead to the other end.
3. The meter must read less than 1 ohm resistance. If the meter reads open, replace the fuse.

■NOTE: Make sure the fuse is returned to its proper position according to amperage.

# Troubleshooting

<b>Problem: Spark absent or weak</b>	
<b>Condition</b>	<b>Remedy</b>
<ol style="list-style-type: none"> <li>1. <b>Ignition coil</b> defective</li> <li>2. <b>Spark plug</b> defective</li> <li>3. <b>Magneto</b> defective</li> <li>4. <b>CDI unit</b> defective</li> </ol>	<ol style="list-style-type: none"> <li>1. Replace ignition coil</li> <li>2. Replace plug</li> <li>3. Replace magneto</li> <li>4. Replace CDI unit</li> </ol>
<b>Problem: Spark plug fouled with carbon</b>	
<b>Condition</b>	<b>Remedy</b>
<ol style="list-style-type: none"> <li>1. <b>Idle RPM</b> too high</li> <li>2. <b>Gasoline</b> incorrect</li> <li>3. <b>Air filter element</b> dirty</li> <li>4. <b>Spark plug</b> incorrect (too cold)</li> </ol>	<ol style="list-style-type: none"> <li>1. Adjust carburetor</li> <li>2. Change to correct gasoline</li> <li>3. Clean element</li> <li>4. Replace plug with proper heat range</li> </ol>
<b>Problem: Spark plug electrodes overheat or burn</b>	
<b>Condition</b>	<b>Remedy</b>
<ol style="list-style-type: none"> <li>1. <b>Spark plug</b> incorrect (too hot)</li> <li>2. <b>Engine</b> overheats</li> <li>3. <b>Spark plug</b> loose</li> </ol>	<ol style="list-style-type: none"> <li>1. Replace plug</li> <li>2. Check cooling fan air intake blockage — damage to fan — cooling shroud</li> <li>3. Tighten plug</li> </ol>
<b>Problem: Magneto does not charge</b>	
<b>Condition</b>	<b>Remedy</b>
<ol style="list-style-type: none"> <li>1. <b>Lead wires — connections</b> shorted — loose — open</li> <li>2. <b>Magneto coils</b> shorted — grounded — open</li> <li>3. <b>Regulator/rectifier</b> shorted — punctured</li> </ol>	<ol style="list-style-type: none"> <li>1. Repair — replace — tighten lead wires</li> <li>2. Replace magneto coils</li> <li>3. Replace regulator/rectifier</li> </ol>
<b>Problem: Magneto charges, but charging rate is below the specification</b>	
<b>Condition</b>	<b>Remedy</b>
<ol style="list-style-type: none"> <li>1. <b>Lead wires</b> shorted — open — loose (at terminals)</li> <li>2. <b>Stator coils (magneto)</b> grounded — open</li> <li>3. <b>Regulator/rectifier</b> defective</li> <li>4. <b>Cell plates (battery)</b> defective</li> </ol>	<ol style="list-style-type: none"> <li>1. Repair — tighten lead wires</li> <li>2. Replace stator coils</li> <li>3. Replace regulator/rectifier</li> <li>4. Replace battery</li> </ol>
<b>Problem: Magneto overcharges</b>	
<b>Condition</b>	<b>Remedy</b>
<ol style="list-style-type: none"> <li>1. <b>Internal battery</b> short circuited</li> <li>2. <b>Regulator/rectifier resistor</b> damaged — defective</li> <li>3. <b>Regulator/rectifier</b> poorly grounded</li> </ol>	<ol style="list-style-type: none"> <li>1. Replace battery</li> <li>2. Replace resistor</li> <li>3. Clean — tighten ground connection</li> </ol>
<b>Problem: Charging unstable</b>	
<b>Condition</b>	<b>Remedy</b>
<ol style="list-style-type: none"> <li>1. <b>Lead wire</b> intermittently shorting</li> <li>2. <b>Magneto</b> internally shorted</li> <li>3. <b>Regulator/rectifier</b> defective</li> </ol>	<ol style="list-style-type: none"> <li>1. Replace lead wire</li> <li>2. Replace magneto</li> <li>3. Replace regulator/rectifier</li> </ol>



<b>Problem: Starter button not effective</b>	
<b>Condition</b>	<b>Remedy</b>
1. <b>Battery charge</b> low 2. <b>Switch contacts</b> defective 3. <b>Starter motor brushes</b> not seating 4. <b>Starter relay</b> defective 5. <b>Emergency stop — ignition switch</b> off 6. <b>Wiring connections</b> loose — disconnected	1. Charge — replace battery 2. Replace switch 3. Repair — replace brushes 4. Replace relay 5. Turn on switches 6. Connect — tighten — repair connections
<b>Problem: Battery “sulfation” (Acidic white powdery substance or spots on surfaces of cell plates)</b>	
<b>Condition</b>	<b>Remedy</b>
1. <b>Charging rate</b> too low — too high 2. <b>Specific gravity</b> too high — too low 3. <b>Battery</b> run down — damaged 4. <b>Electrolyte</b> contaminated	1. Replace battery 2. Charge battery 3. Replace battery 4. Replace battery
<b>Problem: Battery discharges too rapidly</b>	
<b>Condition</b>	<b>Remedy</b>
1. <b>Electrolyte</b> contaminated 2. <b>Specific gravity</b> too high 3. <b>Charging system (charging operation)</b> not set properly  4. <b>Cell plates</b> overcharged — damaged 5. <b>Battery</b> short circuited 6. <b>Specific gravity</b> too low 7. <b>Electrolyte</b> contaminated	1. Replace battery 2. Charge battery 3. Check magneto — regulator/rectifier — circuit connections — adjust for specified charging operation 4. Replace battery — correct charging system 5. Replace battery 6. Charge battery 7. Replace battery
<b>Problem: Battery polarity reversed</b>	
<b>Condition</b>	<b>Remedy</b>
1. <b>Battery</b> incorrectly connected	1. Reverse connections — replace battery

---

---

# Drive System

---

---

## Drive Chain/Sprockets

---

### CHECKING DRIVE CHAIN AND SPROCKETS

The following drive system components should be inspected periodically to ensure proper operation:

- A. Chain (excessive stretch or slack).
- B. Sprockets (excessive wear/hooks, missing or broken teeth).

### ADJUSTING DRIVE CHAIN

1. Loosen the four cap screws (A) securing the rear axle housing to the rear swing arm.

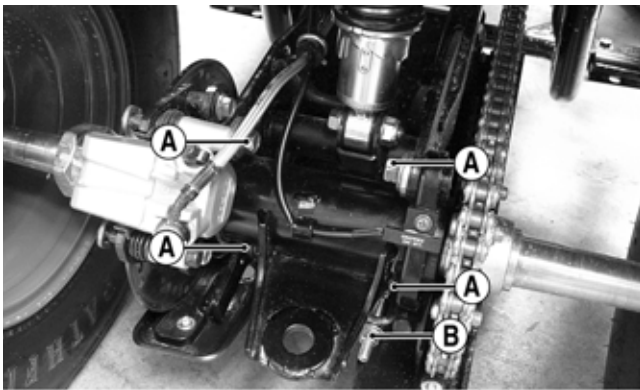

KM831A

2. Tighten the adjuster nut (B) on the adjusting bolt until approximately 30 mm (1.18 in.) of slack is present at mid-span of the chain.

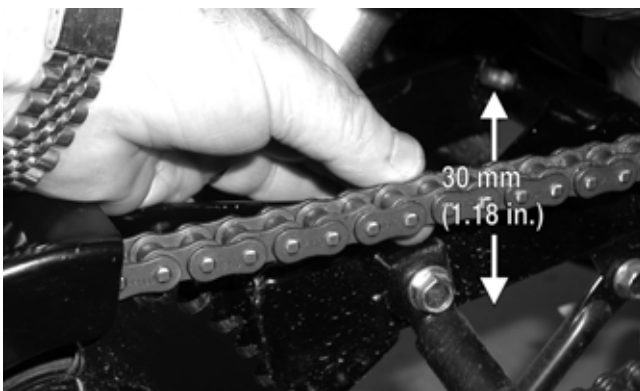

KM218A

3. Tighten the four cap screws.

### REMOVING DRIVE CHAIN

1. Remove the drive chain master link clip.

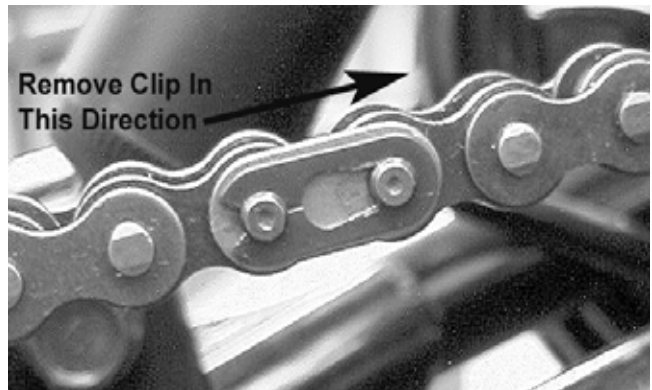

MD2357

2. Remove the link plate and link noting the position of the O-rings; then remove the chain.

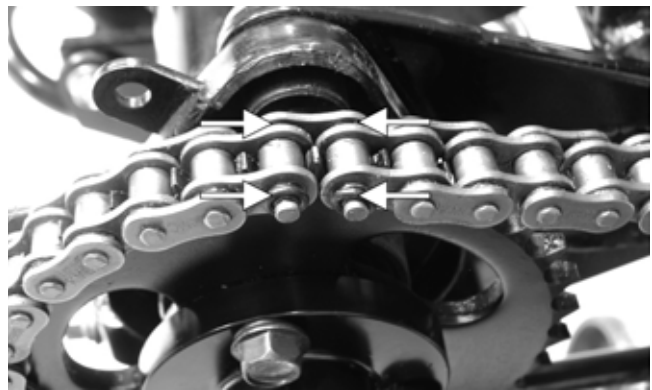

KM238A

### INSTALLING DRIVE CHAIN

1. Place the drive chain into position on the sprockets.
2. Making sure to place the O-rings into position, install the master link, link plate, and link clip.



KM238A

■NOTE: Make sure the closed end of the master link clip faces the direction of the rotation of the chain.

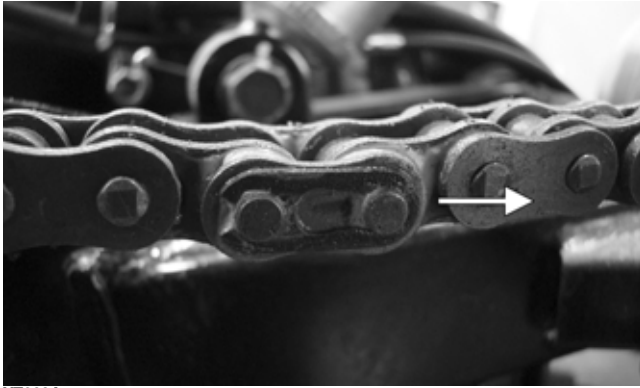

YT263A

### REMOVING FRONT DRIVE SPROCKET

1. With the chain installed and with the rear brake applied, remove the two cap screws securing the spline-lock to the drive sprocket.

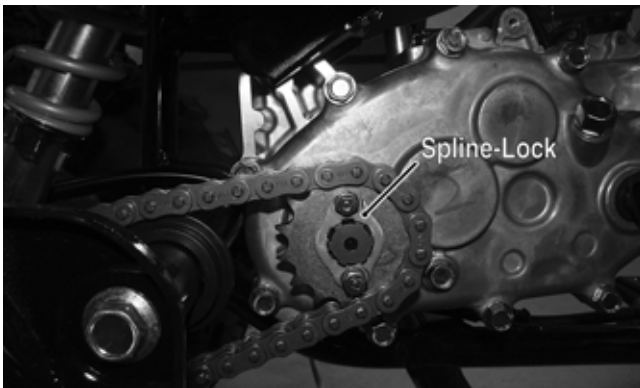

YT009A

2. Loosen the drive chain.
3. Remove the drive sprocket and chain; then remove the sprocket from the chain.

### INSTALLING FRONT DRIVE SPROCKET

1. Place the drive sprocket into the drive chain; then slide onto the driveshaft.
2. Install the spline-lock and two cap screws.
3. Adjust the drive chain.
4. With the rear brake lever lock applied, tighten the cap screws to 8 ft-lb.

### REMOVING REAR SPROCKET

1. Secure the ATV on a support stand to elevate the rear wheels. Remove the hub nut dust covers.

#### **⚠ WARNING**

**Make sure the ATV is solidly supported on the support stand to avoid injury.**

2. Remove the cotter pins from the axle shaft and discard; then apply the parking brake and remove the castle nuts from the axle. Account for the flat washer.

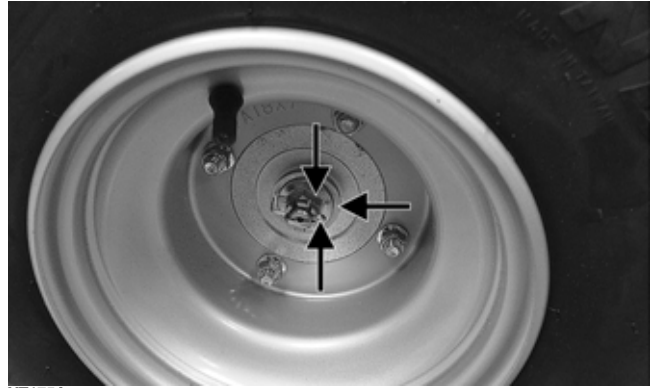

YT175A

3. Remove the left and right rear wheels.
4. Remove the two axle nuts securing the brake hub to the axle; then remove three cap screws securing the rear sprocket to the sprocket retainer.

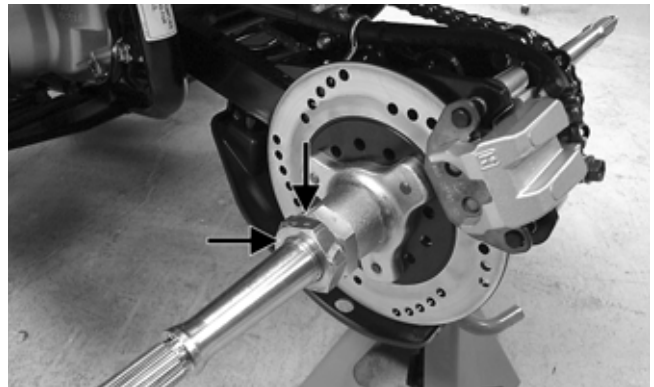

YT195A

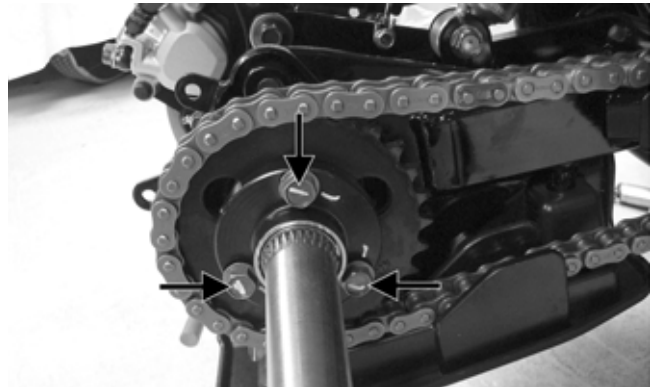

YT197A

**NOTE:** It is not necessary to remove the drive chain in order to remove the rear sprocket.

5. Slide the axle shaft out of the housing from left to right leaving the brake disc and hub and rear sprocket in place. Remove the two cap screws securing the rear chain guard to the axle housing; then lift the rear sprocket out of the chain.



YT198

■NOTE: It is not necessary to remove the chain guard to remove the rear sprocket.

### INSTALLING REAR SPROCKET

■NOTE: Grease all splines with multi-purpose grease and inspect all O-rings in the brake hub and sprocket retainer. O-rings should be replaced whenever disassembled.

1. Position the sprocket into the chain; then slide the axle with sprocket retainer into the housing from the right side. Install the rear chain guard.
2. Secure the rear sprocket to the sprocket retainer with three cap screws and blue Loctite #242 and tighten to 20 ft-lb.

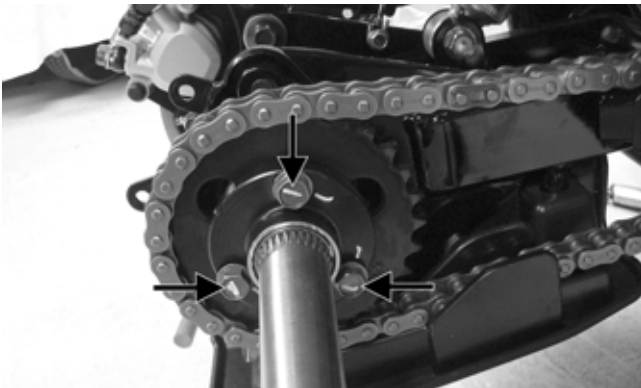

YT197A

3. Coat the axle threads with red Loctite #271 and install one axle nut; then using an appropriate rear axle nut wrench, tighten the inner axle nut to 86 ft-lb.

■NOTE: Set the parking brake to prevent the rear axle from turning.

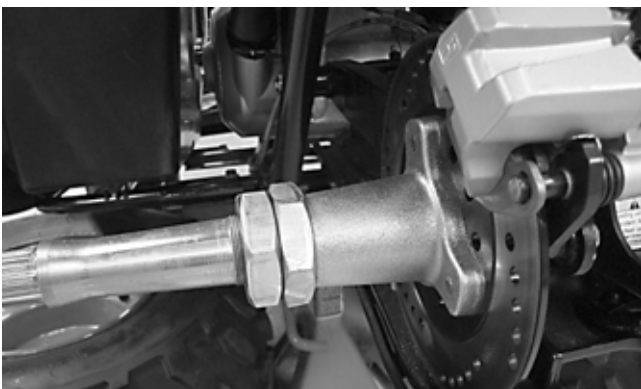

TR235

■NOTE: When using a beam-style torque wrench, it is necessary to calculate the torque value using the following formula due to the offset of the special tool used to tighten the axle nuts. If using a clicker or electronic torque wrench, install the torque wrench at a 90° angle away from the opening of the axle nut wrench.

$$\frac{L \times T_s}{L + L_s} = T$$

T: Torque wrench reading to be calculated

Ts: Specified torque value (86 ft-lb)

Ls: Tool offset length (center to center)

L: Length of torque wrench (handle pivot to headcenter)

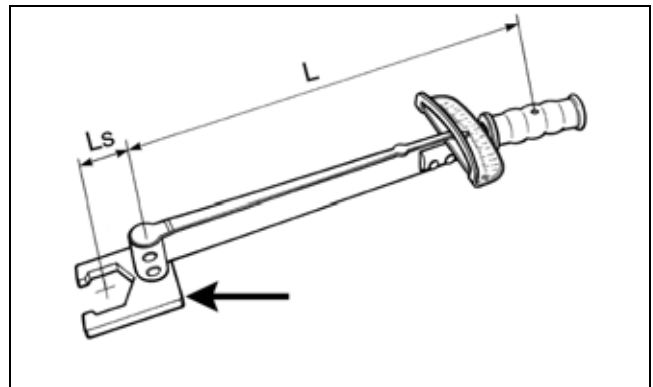

ATV2189

4. Install the outer axle nut and tighten to 86 ft-lb.

5. Adjust the chain.

6. Install the rear wheels/hubs and secure with two flat washers and castle nuts. Tighten to 58 ft-lb; then install new cotter pins.

■NOTE: If cotter pin hole and notch in castle nut do not align, tighten the nut until the first notch will align with the cotter pin hole.

7. Install the rubber hub nut covers and remove the ATV from the support stand.

## Rear Hub/Drive Axle

### REMOVING REAR HUB/DRIVE AXLE

1. Secure the ATV on a support stand to elevate the rear wheels. Remove the hub nut dust covers.

#### ⚠ WARNING

Make sure the ATV is solidly supported on the support stand to avoid injury.

2. Remove the cotter pins from the castle nuts on the rear wheel hubs.
3. Remove the rear wheel hub castle nuts; then slide the rear wheels and hubs off together. Account for the washers.
4. Remove the two axle nuts securing the brake hub to the axle. Remove the chain guard.



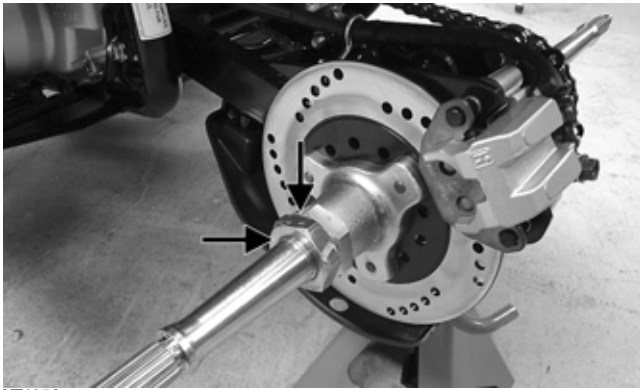

YT195A

5. Remove the drive chain.
6. Remove the rear sprocket.
7. Remove the drive axle by sliding it out the right side of the axle housing.

### **AT THIS POINT**

If the technician's objective is to service/replace the drive axle, the axle housing does not have to be removed from the swing arm. The axle can be pulled out the right side of the axle housing. Axle bearings can also be replaced without removing the axle housing from the swing arm, but the rear axle housing cover and brake hub will need to be removed. The axle housing should only be removed if it needs to be serviced or replaced.

### **REMOVING BEARINGS AND SEALS**

1. Secure the ATV on a support stand to elevate the rear wheels.

### **WARNING**

Make sure the ATV is solidly supported on the support stand to avoid injury.

2. Remove the wheels and hubs.
3. Using an appropriate prying tool, carefully pry out the seals from each side of the axle housing.



KM232

4. Drive out the bearings from the axle housing. Account for center axle housing spacer.

### **REMOVING AXLE HOUSING**

1. Secure the ATV on a support stand to elevate the rear wheels.

### **WARNING**

Make sure the ATV is solidly supported on the support stand to avoid injury.

2. Remove two cap screws securing the brake caliper to the axle housing; then lift the caliper off the disc.

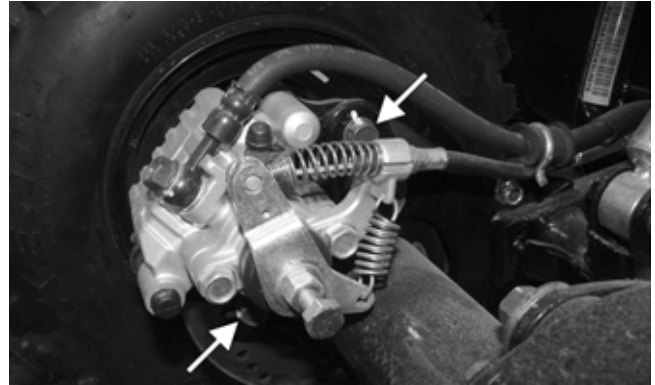

YT235A

3. Remove drive chain, wheels, hubs, and axle as necessary.

**NOTE:** Do not remove more components than necessary to perform the intended service. The axle housing will separate from the swing arm with all components attached if necessary.

4. Remove the four cap screws (A) securing the axle housing to the swing arm; then remove the axle housing.

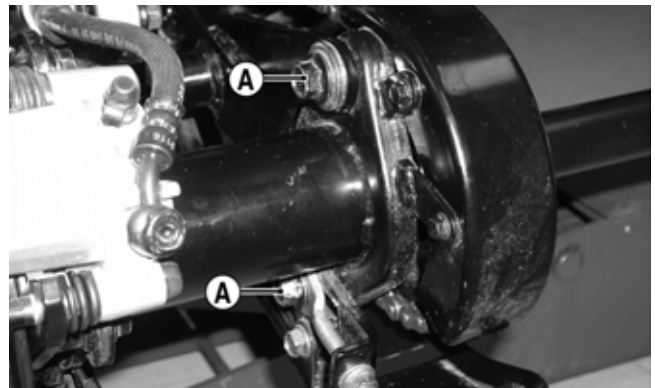

KM217B

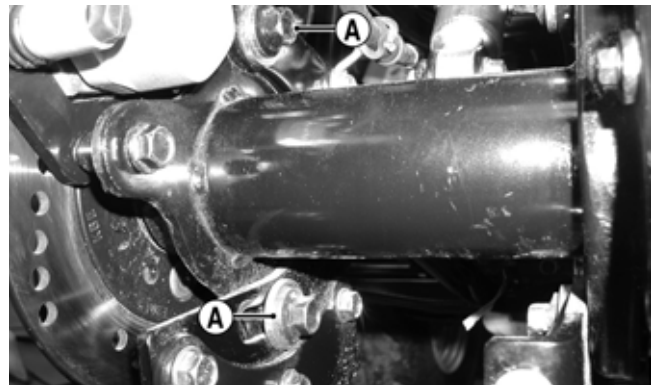

KM212A



## CLEANING AND INSPECTING

■NOTE: Always clean and inspect the drive axle components to determine if any service or replacement is necessary. Replace all components showing signs of wear or damage.

1. Using a clean towel, wipe away any oil or grease.
2. Inspect bearings for smooth operation.
3. Inspect seals for tears, cracks, or deterioration.
4. Inspect splines on axle for damage or wear.
5. Inspect threads on end of axle for damage or stripped threads.
6. Inspect axle for straightness by rolling it on a flat surface and checking for wobble.
7. Inspect axle housing for dents or warpage that might interfere with bearing bore or alignment.

## INSTALLING BEARINGS AND SEALS

1. Using a plastic mallet and bearing driver or appropriate size socket, carefully install the first bearing into the axle housing.



KM226

2. Place the center axle housing spacer in the axle housing; then using a plastic mallet, install the second bearing.

■NOTE: It may be helpful to insert the axle through the previously installed bearing and into the axle housing to align the center axle housing spacer with the bearing bore. Axle installation may be difficult if the spacer is offset from the bearing bore.

3. Apply a light coat of axle bearing grease to the inside (mating surface) of the seals; then using a plastic mallet, install the seals.



KM223

## INSTALLING AXLE HOUSING

1. Position axle housing in swing arm; then install and finger-tighten the four cap screws securing the axle housing to the swing arm.
2. Install the brake caliper to the axle housing.

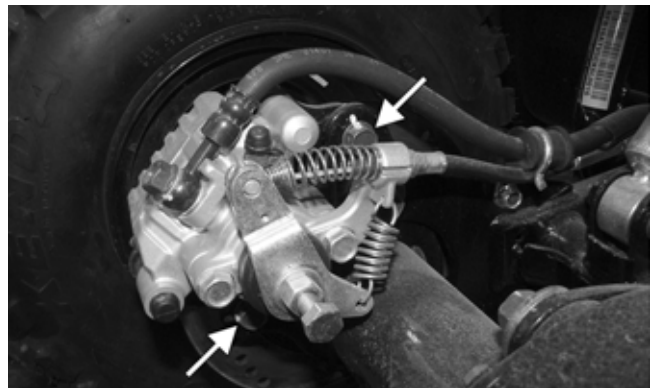

YT235A

3. Install the drive chain.
4. Adjust the drive chain slack; then tighten the four cap screws (from step 1) to 29 ft-lb.

## INSTALLING DRIVE AXLE/REAR HUB

1. Slowly slide the axle into the axle housing.

■NOTE: The axle may have to be turned from side-to-side slightly during installing to get the axle through the center axle housing spacer.

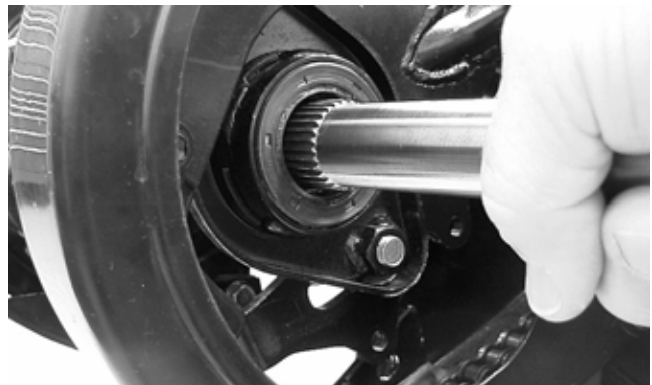

MD2374

2. Slide the axle through the brake disc.



KM234

- Secure the rear sprocket to the sprocket retainer. Tighten the three cap screws (threads coated with blue Loctite #242) to 20 ft-lb. Install the chain guard.

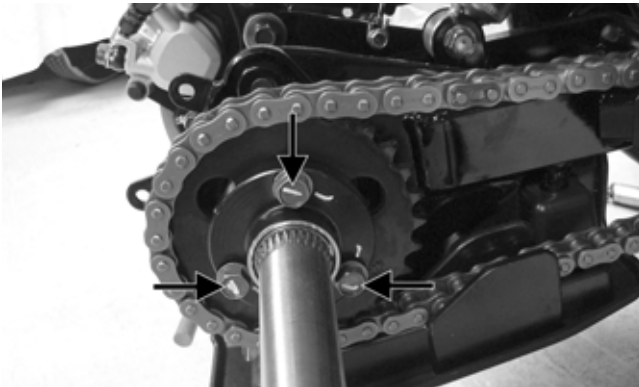

YT197A

- Install the axle nuts securing the brake hub to the axle.
- Install the drive chain.
- Install the rear wheel/hub assemblies. Tighten the castle nuts to 58 ft-lb; then install new cotter pins.

---

## Front Hub

---

### REMOVING HUB

- Secure the ATV on a support stand to elevate the front wheels. Remove the hub nut dust covers; then remove the wheels.

**⚠ WARNING**

**Make sure the ATV is solidly supported on the support stand to avoid injury.**

- Remove the cotter pin from the castle nut.

**NOTE:** During installation, a new cotter pin should be installed.

- Remove the castle nut securing the hub. Account for a washer.

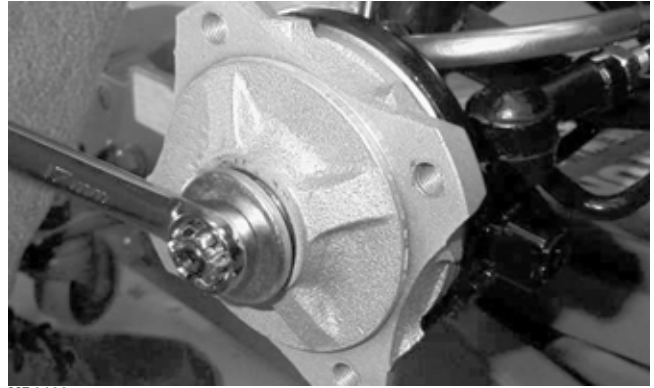

MD2133

- Remove the hub assembly. Account for outer hub spacer.
- Repeat procedure for other hub.

### CLEANING AND INSPECTING

- Clean all hub components.
- Inspect all threads for stripping or damage.
- Inspect the brake shoes for excessive wear or gouges.
- Inspect the sealing area of the hub for pits.
- Inspect the hub splines for signs of wear.
- Inspect the hub for cracks.
- Verify the bearings turn freely.

### REMOVING HUB BEARINGS AND SEALS

- Carefully pry out inner and outer seals.

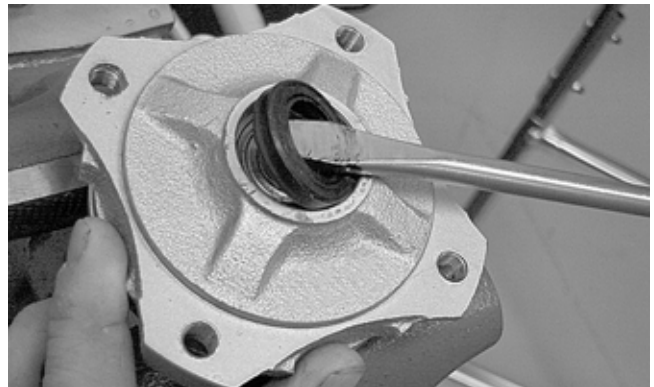

MD2385

- Drive out the inner and outer bearings. Account for a spacer.

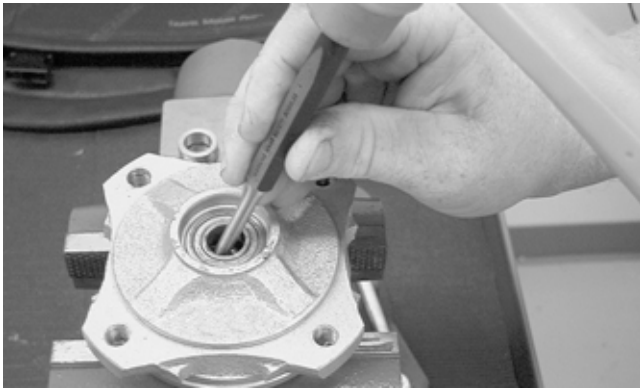

MD2384A

3. Repeat procedure for the other hub.

### INSTALLING HUB BEARINGS AND SEALS

1. Lightly lubricate the bearings with bearing grease; then using a plastic mallet and a bearing driver or appropriate size socket, install the inner bearing into the hub.



YT231

2. Install the inner hub spacer; then install the outer bearing.



YT232

3. Using a plastic mallet, install the inner and outer seals into the hub.

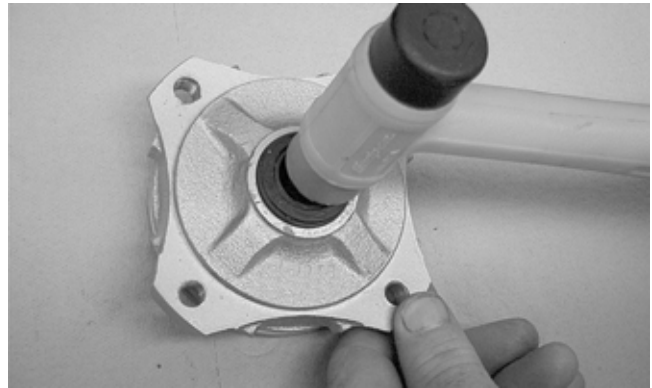

MD2380

4. Repeat procedure for the other hub.

### INSTALLING HUB

1. Lightly lubricate the seals with bearing grease; then install the hub assembly.
2. Install the outer spacer, washer, and castle nut. Tighten the castle nut to 45 ft-lb; then install a new cotter pin. Install the dust cover.

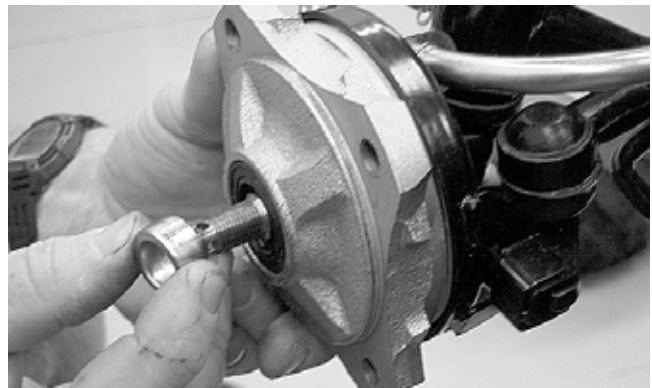

MD2388



MD2354

3. Install wheel. Tighten the four cap screws to 30 ft-lb.
4. Repeat procedure for other hub assembly.

---

## Brake Systems

---

For information regarding the brake systems, see Periodic Maintenance/Tune-Up section.

---



---

## Troubleshooting Drive System

---

Problem: Power not transmitted from engine to wheels	
Condition	Remedy
1. <b>Drive chain</b> worn — broken 2. <b>Countershaft sprocket</b> worn — broken 3. <b>Rear sprocket</b> worn — broken 4. <b>Chain</b> slipped off sprockets 5. <b>Master link</b> worn — broken — missing	1. Replace chain 2. Replace countershaft sprocket 3. Replace rear sprocket 4. Replace — adjust drive chain 5. Replace master link
Problem: Clutch slipping	
Condition	Remedy
1. <b>Clutch shoes</b> worn — damaged	1. Replace clutch shoes
Problem: Clutch dragging	
Condition	Remedy
1. <b>Clutch return springs</b> weak 2. <b>Clutch</b> worn — damaged	1. Replace return springs 2. Replace clutch

---



---

## Troubleshooting Brake System

---

Problem: Braking poor	
Condition	Remedy
1. <b>Brake shoe(s) — pad(s)</b> worn 2. <b>Lever free-play</b> excessive 3. <b>Brake drum(s)</b> worn	1. Replace brake shoe(s) — pad(s) 2. Adjust free-play 3. Replace brake drum(s)
Problem: Brakes drag	
Condition	Remedy
1. <b>Lever free-play</b> less than minimum 2. <b>Brake shoe return spring(s)</b> loose — sprung	1. Adjust free-play 2. Connect — replace return spring(s)

---

---

## Suspension

---

The following suspension system components should be inspected periodically to ensure proper operation:

- A. Shock absorber rods bent, pitted, or damaged.
- B. Rubber damper cracked, broken, or missing.
- C. Shock absorber body damaged, punctured, or leaking.
- D. Shock absorber eyelets broken, bent, or cracked.
- E. Shock absorber eyelet bushings worn, deteriorated, cracked, or missing.
- F. Shock absorber spring broken or sagging.

---

---

## Shock Absorbers

---

### REMOVING FRONT SHOCK ABSORBERS

1. Secure the ATV on a support stand to elevate the wheels and to release the load on the suspension.

**⚠ WARNING**

**Make sure the ATV is solidly supported on the support stand to avoid injury.**

2. Remove the cap screw and self-locking nut securing each front shock absorber to the frame.



MD2131

3. Remove the cap screw and self-locking nut securing each front shock to the A-arms.



MD2132

4. Remove the front shock absorbers.

### REMOVING REAR SHOCK ABSORBER

1. Secure the ATV on a support stand to elevate the wheels and to release the load on the suspension.

**⚠ WARNING**

**Make sure the ATV is solidly supported on the support stand to avoid injury.**

**CAUTION**

**Additional support stands are necessary to support the rear axle when the shock absorbers are removed or damage may occur.**

2. Remove the cap screw securing the rear shock absorber to the frame.



MD2314

3. Remove the cap screw securing the rear shock absorber to the swing arm; then remove the rear shock absorber.

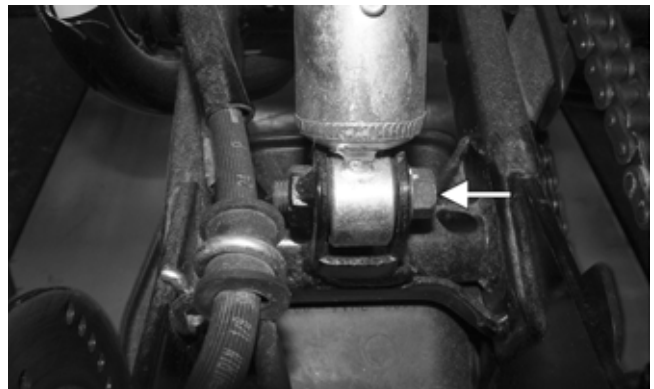

YT264A

4. Compress the shock absorber spring and remove the spring retainer. Remove the spring and spring preload adjuster.

### CLEANING AND INSPECTING

1. Clean all shock absorber components.
2. Inspect each shock rod for nicks, pits, rust, bends, and oily residue.
3. Inspect all springs, spring retainers, shock rods, dampers, bushings, shock bodies, and eyelets for cracks, leaks, and bends.



## INSTALLING FRONT SHOCK ABSORBERS

1. Place a shock absorber into position on the frame and A-arm and install the two cap screws and self-locking nuts. Tighten the nuts to 29 ft-lb.



MD2131



MD2132

2. Repeat the procedure for the other front shock absorber.

### CAUTION

Do not tighten the nuts beyond the 29 ft-lb specification or the shock eyelet or mount WILL be damaged.

3. Remove the ATV from the support stand.

## INSTALLING REAR SHOCK ABSORBER

1. Place the spring preload adjuster and spring over the shock absorber. Compress the spring and install the retainer.
2. Place the shock absorber into position on the frame and swing arm and install the two cap screws. Tighten the cap screws to 29 ft-lb.



MD2314

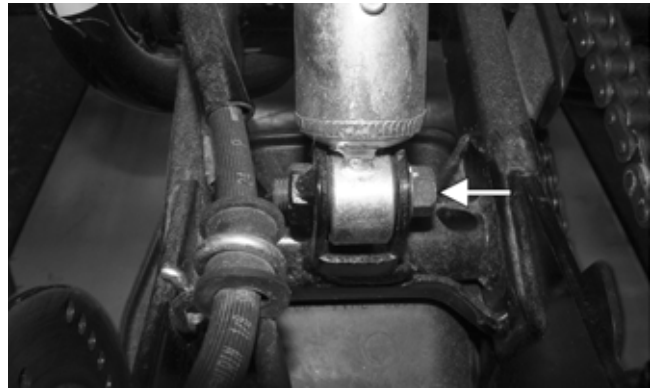

YT264A

### CAUTION

Do not tighten the cap screws beyond the 29 ft-lb specification or the shock eyelet or mount WILL be damaged.

3. Remove the ATV from the support stand.

## A-Arm

### REMOVING

1. Secure the ATV on a support stand to elevate the front wheel; then remove the wheel.

### WARNING

Make sure the ATV is solidly supported on the support stand to avoid injury.

2. Remove the cotter pin, castle nut, and washer; then remove the hub assembly.



MD2133

3. Slide brake backing plate assembly off the spindle shaft and secure it out of the way.
4. Remove the cotter pin from the outer tie rod end; then while holding the flat on the tie rod end, remove the castle nut.



MD2428

5. Remove the tie rod end from the steering knuckle.
6. Remove the rubber spindle pin boot; then remove the cotter pin and flanged castle nut from the spindle pin. Lower the steering knuckle assembly from the A-arm.



MD2113

7. Remove the cap screw and self-locking nut securing the shock absorber to the A-arm.



MD2132

8. Remove the cap screws and self-locking nuts securing the A-arm to the frame.



YT265A

9. Remove the A-arm.



MD2119

## CLEANING AND INSPECTING

1. Clean all A-arm components in parts-cleaning solvent.
2. Clean the tie rod mounting hole of all residual Loctite, grease, oil, or dirt for installing purposes.
3. Inspect the A-arm for bends, cracks, and worn bushings.
4. Inspect the tie rod mounting holes for cracks or damage.
5. Inspect the frame mounts for signs of damage or wear.

## INSTALLING

■NOTE: During installation, new cotter pins should be installed.

1. Lubricate the A-arm bushings with grease; then install the A-arm into the frame. Install the cap screws and self-locking nuts. Tighten the nuts to 29 ft-lb.



MD2425

- Secure the shock absorber to the A-arm with the cap screw and self-locking nut. Tighten the nut to 29 ft-lb.

### CAUTION

Do not tighten the nut beyond the 29 ft-lb specification or the shock eyelet or mount WILL be damaged.



MD2424

- Lubricate the steering knuckle assembly with grease; then install it into the A-arm and secure with the flanged castle nut. Tighten the nut to 29 ft-lb; then install a new cotter pin and the rubber spindle pin boot.

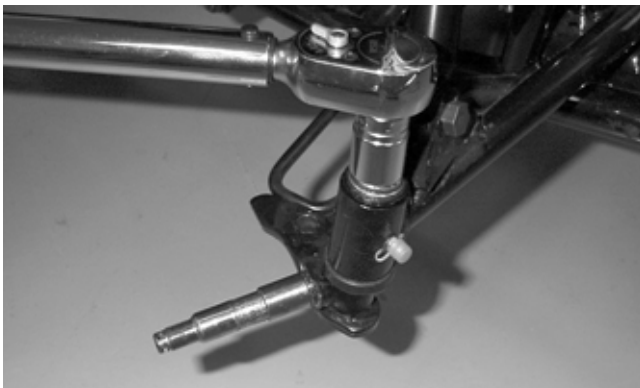

MD2427

- Install the tie rod end into the steering knuckle and secure it with the self-locking nut. Tighten the nut to 25 ft-lb; then install a new cotter pin.



MD2426

- Apply a light coat of grease to spindle shaft; then install the brake backing plate assembly onto the shaft.

■NOTE: When installing the brake backing plate assembly, be sure to align the notch in the backing plate with the tab on the steering knuckle.



MD2381

- Place the hub assembly onto the spindle; then install the washer and castle nut. Tighten the castle nut to 45 ft-lb; then install a new cotter pin. Install the wheel and tighten the cap screws to 30 ft-lb.
- Remove the ATV from the support stand.

### WARNING

After removing and installing brake-related components, ALWAYS check and adjust brakes as necessary before operating the ATV.

## Swing Arm

### REMOVING

- Secure the ATV on a support stand to elevate the rear wheels; then remove the wheels.

### WARNING

Make sure the ATV is solidly supported on the support stand to avoid injury.

- Remove two cap screws securing the brake caliper to the axle housing.

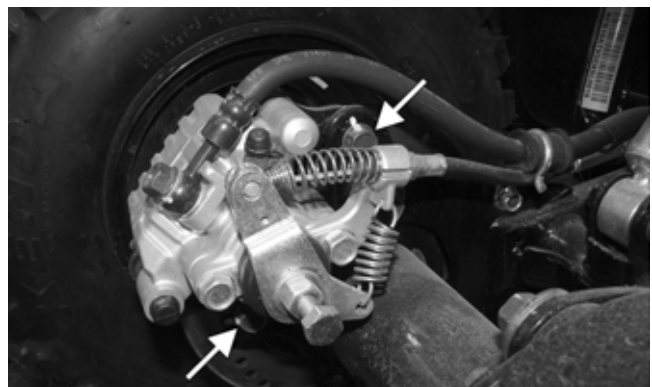

YT235A

- Remove drive chain, hubs, spacers, and axle as necessary (see Drive System).

■NOTE: Do not remove more components than necessary to perform the intended service. The axle housing will separate from the swing arm with all components attached if necessary.

- Remove the four cap screws (A) securing the axle housing to the swing arm; then remove the axle housing.



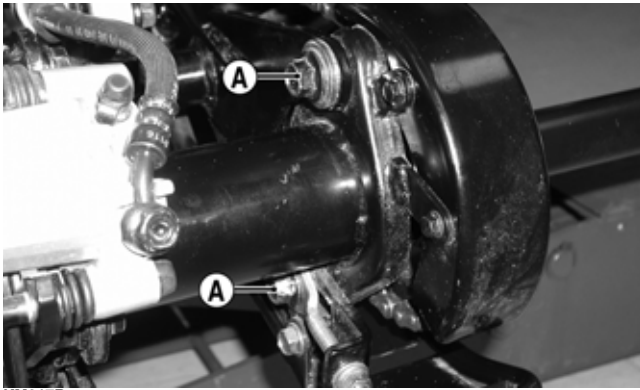

KM217B

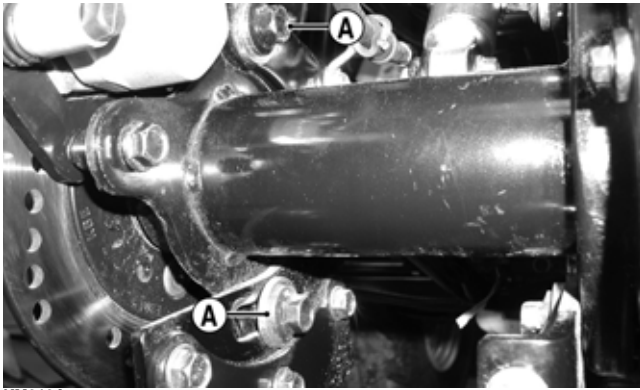

KM212A

5. Remove the cap screws securing the skid plate and rear chain guard; then remove the skid plate and rear chain guard.

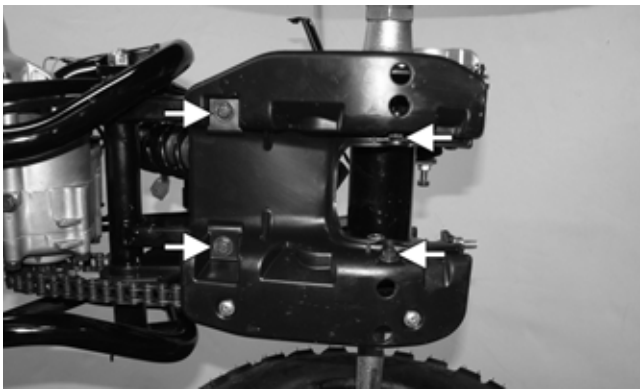

YT266A

6. Remove the cap screw securing the shock absorber to the swing arm.

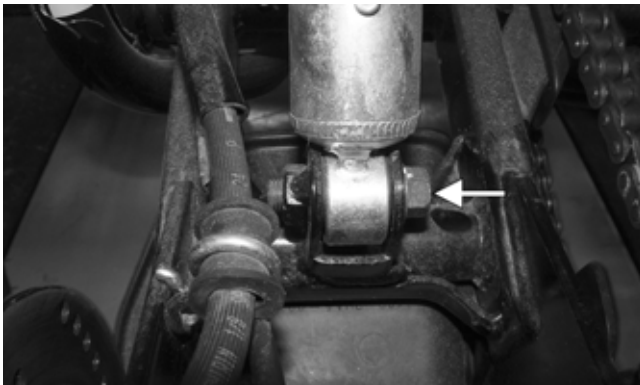

YT264A

7. Remove the long cap screw and self-locking nut securing the front of the swing arm to the frame brackets; then remove the swing arm from the frame. Account for two seals, a spacer, and a rubber swing arm guard.

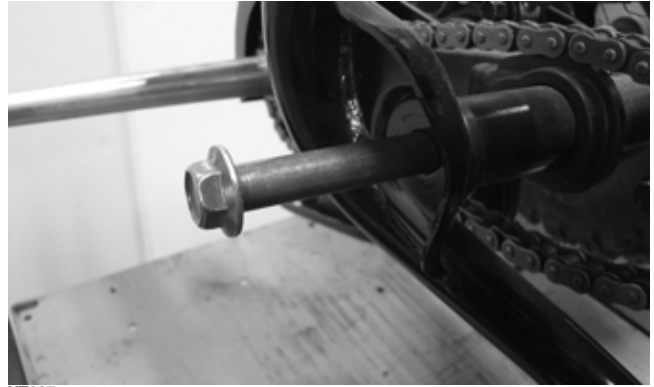

YT267

### CLEANING AND INSPECTING

1. Clean all swing arm components in parts-cleaning solvent.
2. Inspect all swing arm welds for cracks or unusual bends.
3. Inspect all tubing for cracks or unusual bends.
4. Inspect the pressed-in bushings for damage.
5. Inspect the rubber swing arm guard for damage.
6. Inspect the seals for damage.

### INSTALLING

1. Lubricate the pressed-in swing arm bushings with a light coat of grease; then install the spacer into the swing arm.
2. If removed, install the rubber swing arm guard.
3. Lubricate the two seals with a light coat of grease; then install them on the ends of the swing arm.
4. Position the swing arm in the frame and slide the long cap screw through the brackets and swing arm.



YT267

5. Install a new self-locking nut. Tighten the nut to 50 ft-lb.
6. Install the axle, spacers, hubs, and drive chain (see Drive System).

- Secure the shock absorber to the swing arm with the cap screw. Tighten the cap screw to 29 ft-lb.



YT264

### CAUTION

Do not tighten the cap screw beyond the 29 ft-lb specification or the shock eyelet or mount WILL be damaged.

- Place the rear chain guard and skid plate into position and install the cap screws; then tighten the cap screws securely.

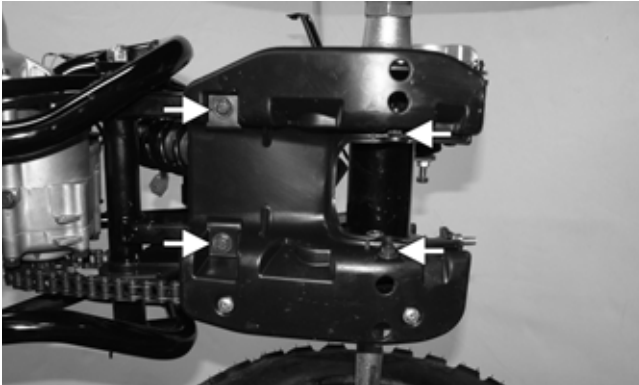

YT266A

- Place the axle housing into position on the swing arm; then install and tighten four cap screws to 29 ft-lb.
- Install the brake caliper on the axle housing with the two cap screws. Tighten securely.

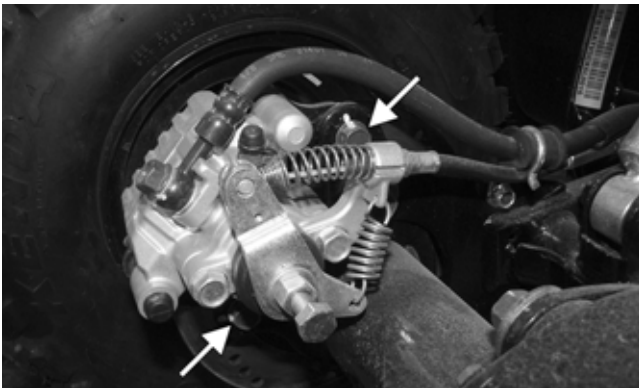

YT235A

- Install the wheels and tighten the cap screws to 30 ft-lb; then remove the ATV from the support stand.

### WARNING

After removing and installing of brake-related components, ALWAYS check and adjust brakes as necessary before operating the ATV.

## Wheels and Tires

### TIRE SIZE

#### WARNING

Use only approved tires when replacing tires. Failure to do so could result in unstable ATV operation.

The ATV is equipped with low-pressure tubeless tires of the size and type listed (see General Information/Foreword — Specifications). Do not under any circumstances substitute tires of a different type or size.

#### WARNING

Do not mix tire tread patterns. Use the same pattern type on front and rear. Failure to heed warning could cause poor handling qualities of the ATV and could cause excessive drive train damage not covered by warranty.

### TIRE INFLATION PRESSURE

Front and rear tire inflation pressure should be 0.21 kg-cm<sup>2</sup> (3.0 psi).

#### WARNING

Always maintain proper tire inflation pressure.

### REMOVING

- Secure the ATV on a support stand to elevate the wheels.

#### WARNING

Make sure the ATV is solidly supported on the support stand to avoid injury.

- Remove the four cap screws securing each wheel; then remove the wheels.

■NOTE: Keep left-side and right-side wheels separated for installing them on their proper sides.

### CLEANING AND INSPECTING

- Clean the wheels and hubs with parts-cleaning solvent.
- Clean the tires with soap and water.
- Inspect each wheel for cracks, dents, or bends.
- Inspect each tire for cuts, wear, missing lugs, and leaks.

### INSTALLING

- Install each wheel on its hub.

■NOTE: Make sure each wheel is installed on its proper hub as noted in removing (the “rotation arrow” must indicate forward direction of rotation).

- Tighten cap screws to 30 ft-lb.

### CHECKING/INFLATING

- Using an air pressure gauge, measure the air pressure in each tire. Adjust the air pressure as necessary to meet the specified inflation pressure.



2. Inspect the tires for damage, wear, or punctures.

**⚠ WARNING**

**Do not operate the ATV if tire damage exists.**

■NOTE: If repair is needed, follow the instructions found on the tire repair kit or remove the wheel and have it repaired professionally by an authorized dealer.

■NOTE: Be sure all tires are the specified size and have identical tread pattern.

3. Test drive the ATV on a dry, level surface and note any pulling to the left or right during acceleration, deceleration, and braking.

■NOTE: If pulling is noted, measure the circumference of the front and rear tires on the pulling side. Compare the measurements with the tires on the opposite side. If pulling is noted during braking only, check and adjust the brakes as necessary and recheck operation (see Periodic Maintenance/Tune-Up).

4. Increase the air pressure in the tires with the smallest circumference measurement until all tires are equal in circumference.
5. Repeat steps 3-4 as necessary to ensure proper handling.

---



---

## Troubleshooting

---

<b>Problem: Suspension too soft</b>	
<b>Condition</b>	<b>Remedy</b>
1. <b>Spring(s)</b> weak 2. <b>Shock absorber</b> damaged	1. Replace spring(s) 2. Replace shock absorber
<b>Problem: Suspension too stiff</b>	
<b>Condition</b>	<b>Remedy</b>
1. <b>A-arm bushings</b> worn 2. <b>Shock absorber</b> improperly adjusted (rear)	1. Replace bushing 2. Adjust shock spring preload
<b>Problem: Suspension noisy</b>	
<b>Condition</b>	<b>Remedy</b>
1. <b>Cap screws (suspension system)</b> loose 2. <b>A-arm bushings</b> worn	1. Tighten cap screws 2. Replace bushings
<b>Problem: Rear wheel oscillation</b>	
<b>Condition</b>	<b>Remedy</b>
1. <b>Rear wheel hub bearings</b> worn — loose 2. <b>Tires</b> defective — incorrect 3. <b>Wheel rim</b> distorted 4. <b>Wheel hub cap screws</b> loose 5. <b>Axle shaft nut</b> loose 6. <b>Rear brake</b> adjusted incorrectly 7. <b>Rear suspension arm-related bushing</b> worn 8. <b>Rear shock absorber</b> damaged 9. <b>Rear suspension arm nut</b> loose	1. Replace bearings 2. Replace tires 3. Replace wheel 4. Tighten cap screws 5. Tighten nut 6. Adjust brake 7. Replace bushing 8. Replace shock absorber 9. Tighten nut

***TRACKER***  
***OFF ROAD***™