

TRACKER
OFF ROAD™

SERVICE MANUAL



p/n: 2263-640-A
1/24

300

Table of Contents

General Information/Foreword	2	Fuel/Lubrication/Cooling	64
Specifications	2	Carburetor	64
Torque Specifications	3	Throttle Cable Free-Play	68
Torque Conversions (ft-lb/N-m)	4	Engine RPM (Idle)	68
Gasoline — Oil — Lubricant	4	Gas Tank	68
Preparation for Storage	5	Gas Tank Valve	69
Preparation after Storage	5	Oil Flow Chart	69
Periodic Maintenance/Tune-Up	6	Oil Pump	69
Air Filter	6	Liquid Cooling System	70
Valve/Tappet Clearance	7	Radiator	70
Testing Engine Compression	7	Hoses/Thermostat	71
Spark Plug	8	Fan	71
Muffler/Spark Arrester	8	Water Pump	71
Engine Oil — Filter	9	Troubleshooting	72
Rear Drive Lubricant	10	Electrical System	73
Transmission Lubricant	10	Battery	73
Driveshaft/Coupling	10	Ignition Switch	74
Shift Lever	11	Ignition Coil	74
Hydraulic Brake Systems	11	Ignition Timing	75
Burnishing Brake Pads	14	Switches	75
Checking/Replacing V-Belt	14	Fan Motor	76
Steering/Body/Controls	16	Lights	76
Front Rack/Body Panel/Fender	16	RPM Limiter	76
Front Fascia/Headlight	19	Magneto Coils	77
Rear Rack/Body Panel/Fender	20	Regulator/Rectifier	77
Steering Post Cover/Instrument Pod	22	Starter Motor	77
Steering Post/Tie Rods	22	Starter Relay	77
Front Wheel Alignment	24	Start-in-Gear Relay	78
Throttle Control	24	Fuse Block	79
Headlight — Taillight/Brake Light	25	Fuses	79
Troubleshooting	26	LCD Gauge Assembly	79
Engine/Transmission	27	CDI Unit	80
Troubleshooting	28	Troubleshooting	81
Removing Engine/ Transmission	31	Drive System	82
Top-Side Components	33	Rear Drive Axle	82
Removing Top-Side Components	33	Front Brake Lever/Master Cylinder Assembly	90
Servicing Top-Side Components	35	Auxiliary Brake Pedal/Master Cylinder Assembly	91
Installing Top-Side Components	39	Troubleshooting Drive System	93
Left-Side Components	41	Troubleshooting Brake System	93
Removing Left-Side Components	41	Suspension	94
Servicing Left-Side Components	42	Front Shock Absorbers	94
Installing Left-Side Components	48	Rear Shock Absorber	94
Right-Side Components	49	Front A-Arms	95
Removing Right-Side Components	49	Wheels and Tires	97
Servicing Right-Side Components	54	Troubleshooting	98
Installing Right-Side Components	58		
Center Crankcase Components	59		
Separating Crankcase Halves	59		
Disassembling Crankcase Half	59		
Servicing Center Crankcase Components	60		
Assembling Crankcase Half	61		
Joining Crankcase Halves	61		
Installing Engine/Transmission	62		

General Information/Foreword



This Service Manual contains service, maintenance, and troubleshooting information for the 2024 300 ATV model and is designed to aid service personnel in service-oriented applications.

This manual is divided into sections. Each section covers a specific ATV component or system and, in addition to the standard service procedures, includes disassembling, inspecting, and assembling instructions. When using this manual as a guide, the technician should use discretion as to how much disassembly is needed to address any given condition.

This service manual is designed primarily for use by a basic level technician. The procedures found in this manual are of varying difficulty, and certain service procedures in this manual require one or more special tools to be completed. The technician should use sound judgment when determining which procedures can be completed based on their skill level and access to appropriate special tools.

NOTE: Whenever a part is worn excessively, cracked, or damaged in any way, replacement is necessary.

When replacement of parts is necessary, use only genuine ATV parts. They are precision-made to ensure high quality and correct fit. Refer to the appropriate Illustrated Parts Manual for the correct part number, quantity, and description.

ATV publications and decals display the words Warning, Caution, Note, and At This Point to emphasize important information. The symbol  **WARNING** identifies personal safety-related information. Be sure to follow the directive because it deals with the possibility of serious injury or even death. A **CAUTION** identifies unsafe practices which may result in ATV-related damage. Follow the directive because it deals with the possibility of damaging part or parts of the ATV. The symbol **NOTE:** identifies supplementary information worthy of particular attention. The symbol  **AT THIS POINT** directs the technician to certain and specific procedures to promote efficiency and to improve clarity.

At the time of publication, all information, photographs, and illustrations were technically correct. Some photographs used in this manual are used for clarity purposes only and are not designed to depict actual conditions. Because products are constantly refined and improved, no retroactive obligation is incurred.

All materials and specifications are subject to change without notice.

Specifications

NOTE: Specifications subject to change without notice.

CHASSIS	
Dry Weight (approx.)	216.4 kg (477 lb)
Length (Overall)	184.2 cm (72.5 in)
Height (Overall)	116.8 cm (46.0 in)
Width (Overall)	102.1 cm (40.5 in)
Tire Size	(Front) AT22 x 7-10 (Rear) AT22 x 10-10
Tire Inflation Pressure	34.47 kPa (5 psi)
MISCELLANEOUS	
Engine Bore x Stroke	72.7 x 65.2 mm (2.86 x 2.57 in)
Engine Displacement	270 cc (16.5 cu in)
Spark Plug Type	NGK DPR7EA-9
Spark Plug Gap	0.6-0.7 mm (0.023-0.027 in)
Gas Tank Capacity	12.8 L (3.4 U.S. gal)
Reserve Capacity	4.54 L (1.2 U.S. gal)
Engine Oil Capacity	1.4 L (1.5 U.S. qt)
Transmission	(Overhaul) 600 mL (20.3 fl oz)
Lubricant Capacity	(Change) 500 mL (16.9 fl oz)
Gasoline (Recommended)	87 Octane Regular Unleaded
Engine Oil (Recommended)	ACX All Weather (Synthetic)
Cooling System Capacity	1.4 L (1.5 U.S. qt)
Rear Drive Capacity	(Overhaul) 150 mL (5 fl oz)
	(Change) 98.5 mL (3.33 fl oz)
Rear Drive Lubricant	SAE-Approved 80W-90 Hypoid
Brake Fluid	DOT 4
Taillight/Brake Light	12 V/5 W/21 W
Headlight	12 V/35 W (2)
FUEL SYSTEM	
Carburetor Type	Keihin CVK32
Main Jet	112
Starter Jet	60
Slow Jet	38
Needle Jet	4.0/3.6
Jet Needle	NLRA
Idle RPM	1250-1350
Float Arm Height	17.0 mm (0.67 in)
Throttle Cable Free-Play (at lever)	1-4 mm (1/16-3/16 in)
ELECTRICAL SYSTEM	
Ignition Timing	5° BTDC ("F" mark) @ 1000 RPM
Spark Plug Cap	4500-6150 ohms
Ignition Coil Resistance (Primary)	2.4-3.0 ohms
	(Secondary) 12,300-16,600 ohms
Magneto Coil Resistance (Trigger)	105-110 ohms
	(Charging) Less than 1 ohm
Magneto Output (Approx.)	220 W @ 5000 RPM
Stator Coil Output (no load)	40-60 AC volts @ 3500 RPM
CAMSHAFT AND CYLINDER HEAD	
Cam Lobe Height (min.) (Intake)	34.15 mm
	(Exhaust) 34.05 mm
Rocker Arm/Shaft Clearance (max.)	0.1 mm
Cylinder Head/Cover Distortion (max.)	0.05 mm

CYLINDER, PISTON, AND RINGS	
Piston Skirt/Cylinder Clearance (max.)	0.12 mm
Cylinder Bore	72.705-72.715 mm
Piston Diameter 18 mm from Skirt End (max.)	72.625 mm
Cylinder Trueness (max.)	0.05 mm
Piston Ring to Groove Clearance (max.) (1st/2nd)	0.09 mm
Piston Ring End Gap — Installed (1st) (2nd) (Oil)	0.15-0.30 mm 0.30-0.45 mm 0.20-0.70 mm
Piston Pin Bore (max.)	17.06 mm
Piston Pin Outside Diameter (min.)	16.96 mm
CRANKSHAFT	
Connecting Rod (small end inside diameter) (max.)	17.06 mm
Connecting Rod (big end side-to-side)	0.05-0.40 mm
Connecting Rod (small end deflection) (max.)	1 mm
Crankshaft (web-to-web)	55.15-55.20 mm
Crankshaft Runout (max.)	0.1 mm
Oil Pressure at 60°C (140°F) @ 3000 RPM (above) (below)	0.3 kg/cm ² (4.3 psi) 0.7 kg/cm ² (10 psi)
TRANSMISSION	
Clutch Release Screw	1/8 turn back
Drive Plate (fiber) Thickness (min.)	2.4 mm
Drive Plate (fiber) Tab (min.)	11 mm
Driven Plate (warpage) (max.)	0.1 mm
Clutch Spring Length (min.)	27.5 mm
Clutch Wheel Inside Diameter (max.)	Scuffing of contact surface
Clutch Shoe Lining Thickness	0.5 mm
Clutch Engagement RPM	2000 ± 200
Clutch Lock-Up RPM	3400 ± 300
VALVES AND GUIDES	
Valve/Tappet Clearance (Intake/Exhaust) (cold engine)	0.1 mm
Valve Guide/Stem Clearance (max.) (Intake) (Exhaust)	0.06 mm 0.08 mm
Valve Spring Free Length (min) (Inner) (Outer)	29.4 mm 39.0 mm
Valve Spring Tension @ 18.0 mm (Intake)	10.2-11.8 kg (22.5-26.0 lb)
Valve Spring Tension @ 21.5 mm (Exhaust)	19.05-22.0 kg (42.0-48.5 lb)

Torque Specifications

Part	Part Bolted to	Torque ft-lb N-m	
STEERING COMPONENTS			
Handlebar Clamp Cap Screw	Steering Head	18	24
Steering Post Support Block	Frame	17	23
Steering Post Nut	Steering Post	50	68
Upper And Lower Ball Joint Nut	Steering Knuckle	22	30
Tie Rod End Nut	Steering Knuckle	15	20
Tie Rod Lock Nut	Tie Rod	15	20
ELECTRICAL COMPONENTS			
Starter Motor Lead Cable Nut	Starter	36 in-lb	4
Starter Motor Mounting Bolt	Crankcase	9	12
EXHAUST COMPONENTS			
Exhaust Pipe	Engine	25	34
Muffler Mounting Bolt	Frame	25	34

Part	Part Bolted to	Torque ft-lb N-m	
BRAKE COMPONENTS			
Brake Hose Union Bolt	Master Cylinder/ Caliper	25	34
Brake Bleed Screw	Caliper	56 in-lb	6
Brake Caliper Mounting Cap Screw	Steering Knuckle/ Swing Arm	25	34
Master Cylinder (Front)	Handlebar	13	18
Brake Pad Mounting Pin (Front/Rear)	Brake Caliper	13	18
Brake Caliper Slide Pin (Front/Rear)	Brake Caliper	25	34
Front Brake Line Nut	Brake Line/Junction Block	25	34
Brake Caliper (Rear)	Swing Arm Housing	25	34
SUSPENSION COMPONENTS (Front)			
A-Arm Pivot Nut	Frame	32	44
Front Shock Absorber Mounting Nut* (Upper/Lower)	Frame	29	39
SUSPENSION COMPONENTS (Rear)			
Left Pivot Bolt	Swing Arm	36 in-lb	4
Right Pivot Bolt	Swing Arm	82	112
Left Pivot Lock Nut	Left Pivot Bolt	82	112
Rear Shock Absorber Mounting Nut (Upper/Lower)	Frame/Swing Arm	29	39
Axle Housing Cap Screw	Final Drive Gear Case	40	54
DRIVETRAIN COMPONENTS			
Engine Mounting Through-Bolt	Frame	29	39
Engine Mounting Bracket Cap Screw	Frame	16	22
Rear Axle Housing	Swing Arm	40	54
Gear Case	Swing Arm	50	68
Pinion Nut	Shaft	72	98
Gear Case Cover (8 mm) (10 mm)	Gear Case	19 36	26 49
Hub Nut (Front)	Front/Spindle	50	68
Wheel Lug Nut	Hub	40	54
Hub Nut (Rear)	Axle	72	98
Rear Axle Nut*	Axle	72	98
ENGINE/TRANSMISSION			
Cylinder Head	Cylinder	7	10
Cylinder Nut	Crankcase	7	10
Camshaft Holder	Cylinder Head	18	24
Bevel Drive Gear	Driveshaft	72	98
Magneto Rotor/Flywheel	Crankshaft	47	64
Bevel Driven Gear	Driven Shaft	72	98
Crankcase Cap Screw	Crankcase	8	11
Engine Oil Screen/Filter Cap	Crankcase	11	15
Shift Cam Stopper Plug*	Left Case	20	27
Camshaft Chain Tensioner Adjuster	Cam Chain Tensioner	9	12
Cam Chain Tensioner Cover Bolt	Tensioner	24 in-lb	3
Starter Ratchet	Crankshaft	68	92
Camshaft Chain Tensioner Mount	Cylinder Head	9	12
Camshaft Chain Tension Spring Holder Plug	Cam Chain Tensioner	36 in-lb	4
Centrifugal Clutch Housing	Driveshaft	40	54
Timing Plug	Right Case	16	22
Driven Pulley Retaining Nut	Driven Shaft (Transmission)	43	59
Drive Plate Nut*	Fixed Driven Face	43	59
Drive Pulley Nut	Crankshaft	72	98
Engine Oil Drain Plug	Crankcase	21	29
Transmission Drain Plug	Transmission	21	29
Transmission Case Cover	Transmission	20	27

*w/Red Loctite #271

Torque Conversions (ft-lb/N-m)

ft-lb	N-m	ft-lb	N-m	ft-lb	N-m	ft-lb	N-m
1	1.4	26	35.4	51	69.4	76	103.4
2	2.7	27	36.7	52	70.7	77	104.7
3	4.1	28	38.1	53	72.1	78	106.1
4	5.4	29	39.4	54	73.4	79	107.4
5	6.8	30	40.8	55	74.8	80	108.8
6	8.2	31	42.2	56	76.2	81	110.2
7	9.5	32	43.5	57	77.5	82	111.5
8	10.9	33	44.9	58	78.9	83	112.9
9	12.2	34	46.2	59	80.2	84	114.2
10	13.6	35	47.6	60	81.6	85	115.6
11	15	36	49	61	83	86	117
12	16.3	37	50.3	62	84.3	87	118.3
13	17.7	38	51.7	63	85.7	88	119.7
14	19	39	53	64	87	89	121
15	20.4	40	54.4	65	88.4	90	122.4
16	21.8	41	55.8	66	89.8	91	123.8
17	23.1	42	57.1	67	91.1	92	125.1
18	24.5	43	58.5	68	92.5	93	126.5
19	25.8	44	59.8	69	93.8	94	127.8
20	27.2	45	61.2	70	95.2	95	129.2
21	28.6	46	62.6	71	96.6	96	130.6
22	29.9	47	63.9	72	97.9	97	131.9
23	31.3	48	65.3	73	99.3	98	133.3
24	32.6	49	66.6	74	100.6	99	134.6
25	34	50	68	75	102	100	136

Gasoline — Oil — Lubricant

FILLING GAS TANK

⚠ WARNING

Always fill the gas tank in a well-ventilated area. Never add fuel to the ATV gas tank near any open flames or with the engine running. **DO NOT SMOKE** while filling the gas tank.

Since gasoline expands as its temperature rises, the gas tank must be filled to its rated capacity only. Expansion room must be maintained in the tank particularly if the tank is filled with cold gasoline and then moved to a warm area.

⚠ WARNING

Do not overflow gasoline when filling the gas tank. A fire hazard could materialize. Always allow the engine to cool before filling the gas tank.

⚠ WARNING

Do not over-fill the gas tank.

Tighten the gas tank cap securely after filling the tank.

RECOMMENDED GASOLINE

The recommended gasoline to use is 87 minimum octane regular unleaded. In many areas, oxygenates are added to the gasoline. Oxygenated gasoline containing up to 10% (maximum) ethanol is acceptable.

When using ethanol-blended gasoline, it is not necessary to add a gasoline antifreeze since ethanol will prevent the accumulation of moisture in the fuel system.

CAUTION

Do not use white gas. Only approved gasoline additives should be used.

RECOMMENDED ENGINE OIL

CAUTION

Any oil used in place of the recommended oil could cause serious engine damage. Do not use oils which contain graphite or molybdenum additives. These oils can adversely affect clutch operation. Also, not recommended are racing, vegetable, non-detergent, and castor-based oils.

The recommended oil to use is ACX All Weather synthetic engine oil, which has been specifically formulated for use in this engine. Although ACX All Weather synthetic engine oil is the only oil recommended for use in this engine, use of any API-certified SM 0W-40 oil is acceptable.

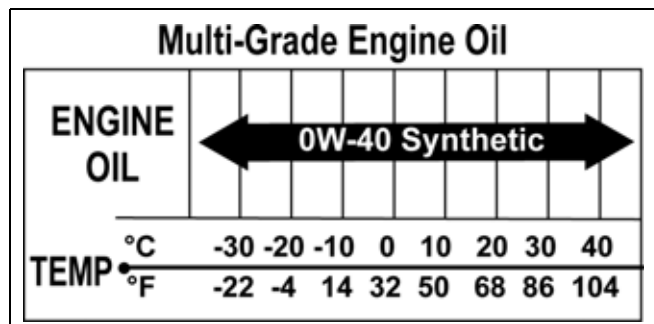

OILCHARTJ

RECOMMENDED REAR DRIVE LUBRICANT

The recommended lubricant is SAE-approved 80W-90 hypoid. This lubricant meets all the lubrication requirements of the rear drive.

CAUTION

Any lubricant used in place of the recommended lubricant could cause serious rear drive damage.

RECOMMENDED TRANSMISSION LUBRICANT

The recommended lubricant is SAE-approved 80W-90 hypoid. This lubricant meets all the lubrication requirements of the transmission.

CAUTION

Any lubricant used in place of the recommended lubricant could cause serious transmission damage.

Preparation for Storage

CAUTION

Prior to storing the ATV, it must be properly serviced to prevent rusting and component deterioration.

Use the following procedure to prepare the ATV for storage:

2. Clean the entire ATV thoroughly by washing off dirt, oil, grass, and other foreign matter. Clean the seat cushion (cover and base) with a damp cloth. Allow the ATV to dry thoroughly. **DO NOT** get water into any part of the engine or air intake.
3. Either drain the gas tank or add Fuel Stabilizer to the gas in the gas tank.
4. Clean the interior of the air filter housing.
5. Drain the carburetor float chamber.
6. Plug the exhaust hole in the exhaust system with steel wool.
7. Apply light oil to the upper steering post bushing and plungers of the shock absorbers.
8. Tighten all nuts, bolts, cap screws, and screws. Make sure rivets holding components together are tight. Replace all loose rivets. Care must be taken that all calibrated nuts, cap screws, and bolts are tightened to specifications.
9. Fill the cooling system to the **FULL** line in the cooling system reservoir with properly mixed coolant.
10. Disconnect the battery cables; then remove the battery, clean the battery posts and cables, and store in a clean, dry area.

■**NOTE:** For storage, use a battery maintainer or make sure the battery is fully charged (see **Battery** section in this manual).

11. Store the ATV indoors in a level position.

CAUTION

Avoid storing outside in direct sunlight and avoid using a plastic cover as moisture will collect on the ATV causing rusting.

Preparation after Storage

Taking the ATV out of storage and correctly preparing it will ensure many miles and hours of trouble-free riding. Use the following procedure to prepare the ATV:

1. Clean the ATV thoroughly.
2. Remove the steel wool from the exhaust system.
3. Check all control wires and cables for signs of wear or fraying. Replace if necessary.
4. Change the engine oil and filter.
5. Check the coolant level and add properly mixed coolant as necessary.
6. Charge the battery; then install. Connect the battery cables making sure to connect the positive cable first.

CAUTION

The ignition switch must be in the OFF position prior to installing the battery or damage may occur to the ignition system.

7. Check the entire brake systems (fluid level, pads, etc.), all controls, headlights, taillight, brake light, and headlight aim; adjust or replace as necessary.
8. Tighten all nuts, bolts, cap screws, and screws making sure all calibrated nuts, cap screws, and bolts are tightened to specifications.
9. Check tire pressure. Inflate to recommended pressure as necessary.
10. Make sure the steering moves freely and does not bind.
11. Check the spark plug. Clean or replace as necessary.
12. Check the air filter and the air filter housing. Clean or replace as necessary.

Periodic Maintenance/Tune-Up

Tighten all nuts, bolts, and cap screws. Make sure rivets holding components together are tight. Replace all loose rivets. Care must be taken that all calibrated nuts, bolts, and cap screws are tightened to specifications (See General Information/Foreword).

It is advisable to lubricate certain components periodically to ensure free movement. Apply light oil to the components using the following list as reference:

- A. Throttle Lever Pivot/Cable Ends
- B. Brake Lever Pivot
- C. Auxiliary Brake Pivot/Clevis
- D. Choke Cable Upper End
- E. Shift Lever/Ball Joints
- F. Idle RPM Screw

SPECIAL TOOLS

A number of special tools must be available to the technician when performing service procedures in this section. Refer to the current Special Tools Catalog for the appropriate tool description.

■NOTE: When indicated for use, each special tool will be identified by its specific name, as shown in the chart below, and capitalized.

Description	p/n
Compression Tester Kit	0444-213
Tappet Adjuster	0444-189

■NOTE: Special tools are available from the Service Parts Department.

Air Filter

Use the following procedure to remove the filter and inspect and/or clean it:

CLEANING AND INSPECTING FILTER

CAUTION

Failure to inspect the air filter frequently if the vehicle is used in dusty, wet, or muddy conditions can damage the engine.

1. Remove the seat.
2. Remove the air filter housing cover from the retaining clips.



KM095A

3. Remove the air filter retaining cap screw (1); then remove the foam elements (2) from the frame.

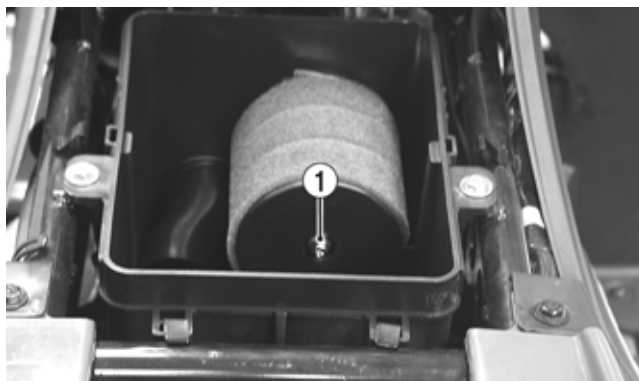

KM097A



KM098A

4. Place the elements in a pan larger than each element and spray generously with cleaning solvent. Let sit approximately three minutes.

■NOTE: Foam Filter Cleaner and Foam Air Filter Oil Aerosol are available.

5. In a pan larger than each element, using a mild detergent (dish soap) and water, wash off all dirt and oil by squeezing each element, not by twisting it (wringing out or twisting the filter can cause damage).
6. Rinse off any remaining soap.

- Remove any excess water from the elements by matting with a towel; then allow the elements to dry completely.

CAUTION

A torn air filter can cause damage to the ATV engine. Dirt and dust may get inside the engine if the element is torn. Carefully examine the element for tears before and after cleaning it. Replace the element with a new one if it is torn.

- Spray oil generously onto the air filter elements and work the oil in. Squeeze the elements to remove excess oil.
- Clean any dirt or debris from inside the air cleaner. Make sure no dirt enters the carburetor.
- Install the foam elements onto the frame; then place the assembly into position in the housing and secure with the retaining cap screw.
- Install the air filter housing cover and secure with the retaining clips; then install the seat making sure it locks securely.

CHECKING/DRAINING DRAIN TUBE

Periodically check the drain tube for gasoline or oil accumulation. If noticed, remove the drain tube cap from beneath the housing and drain the gasoline or oil into a suitable container; then install and secure the tube cap.



KM114

Valve/Tappet Clearance

To check and adjust valve/tappet clearance, use the following procedure:

■NOTE: Check and adjust valve clearances when the engine is cold.

■NOTE: The seat assembly, side panels, and gas tank must be removed for this procedure.

- Remove the timing inspection plug and flywheel nut cover; then remove the cylinder head cover (see Engine/Transmission — Removing Top-Side Components).
- Rotate the crankshaft so the “T” mark on the flywheel aligns with the index mark on the right-side crankcase cover.

■NOTE: At this point, the round hole in the camshaft gear should be up.

- Place Tappet Adjuster onto the jam nut securing the tappet adjuster screw; then rotate the adjuster dial clockwise until the end is seated in the tappet adjuster screw.
- While holding the adjuster dial in place, use the adjuster handle and loosen the jam nut; then rotate the tappet adjuster screw clockwise until friction is felt.
- Align the adjuster handle with one of the marks on the adjuster dial.
- While holding the adjuster handle in place, rotate the adjuster dial counterclockwise until proper valve/tappet clearance is attained.

■NOTE: Refer to the appropriate specifications in Engine/Transmission for the proper valve/tappet clearance.

■NOTE: Rotating the adjuster dial counterclockwise will open the valve/tappet clearance by 0.05 mm (0.002 in) per mark.

- While holding the adjuster dial at the proper clearance setting, tighten the jam nut securely with the valve adjuster handle.
- Place the cylinder head cover with a new O-ring into position; then tighten the cover securely.



KM703

- Install the timing inspection plug.

Testing Engine Compression

- Remove the high tension lead from the spark plug.

WARNING

Disable fuel and ignition systems to prevent potential hazards.

- Using compressed air, blow any debris from around the spark plug.

WARNING

Always wear safety glasses when using compressed air.

3. Remove the spark plug; then attach the high tension lead to the plug and ground the plug on the cylinder head well away from the spark plug hole.
4. Attach the gauge from Compression Tester Kit.

■**NOTE:** The engine must be warm and the battery must be fully charged for this test.

5. While holding the throttle lever in the full-open position, crank the engine over with the electric starter until the gauge shows a peak reading (five to 10 compression strokes).

■**NOTE:** The compression should be within a range of 210-230 psi in the full-open throttle position.

6. If compression is abnormally low, verify the following items:
 - A. Starter cranks engine over.
 - B. Gauge functions properly.
 - C. Throttle lever in the full-open position.
 - D. Valve/tappet clearance correct.
 - E. Valve not bent or discolored.
 - F. Valve seat not discolored.

■**NOTE:** To service valves, see Engine/Transmission — Servicing Top-Side Components.

7. Pour 29.5 mL (1 fl oz) of oil into the spark plug hole, attach the gauge, and test compression.
8. If compression is now evident, service the top end (see Engine/Transmission — Servicing Top-Side Components).

Spark Plug

A light brown insulator indicates that the plug and air/fuel ratio are correct. A white or dark insulator indicates that the engine may need to be serviced or the carburetor may need to be adjusted. To maintain a hot, strong spark, keep the plug free of carbon.

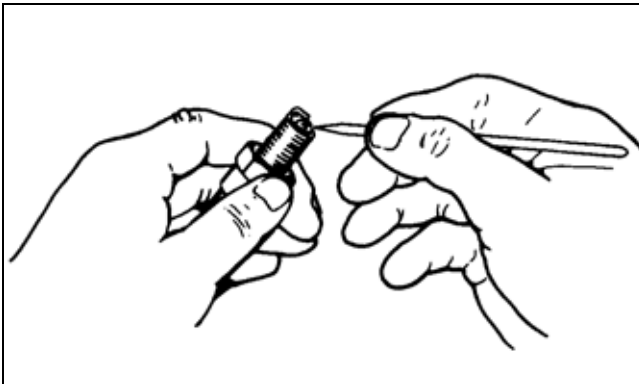

ATV-0051

CAUTION

Before removing the spark plug, make sure to clean the area around the spark plug. Dirt could enter engine when removing or installing the spark plug.

Adjust the gap to 0.8-0.9 mm (0.032-0.036 in) for proper ignition. Use a feeler gauge to check the gap.

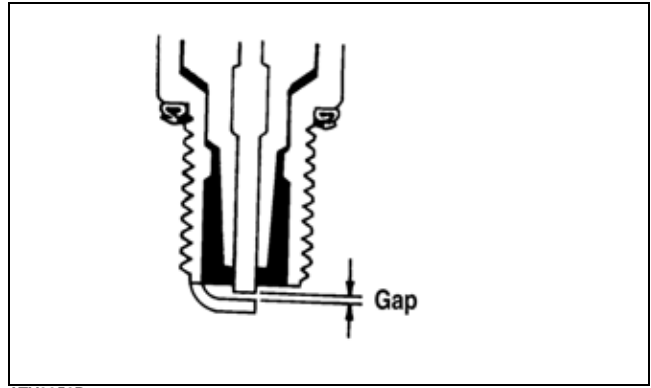

ATV0052B

A new spark plug should be tightened 1/2 turn once the washer contacts the cylinder head. A used spark plug should be tightened 1/8-1/4 turn once the washer contacts the cylinder head.

Muffler/Spark Arrester

The muffler has a spark arrester which must be periodically cleaned. At the intervals shown in the Periodic Maintenance Chart, clean the spark arrester using the following procedure:

⚠ WARNING

Wait until the muffler cools to avoid burns.

1. Remove the cap screw (1) securing the spark arrester (2) to the muffler assembly; then carefully remove the spark arrester.



KM139A

2. Using a soft wire brush, clean the carbon from the screen (3) taking care not to tear or damage the screen.

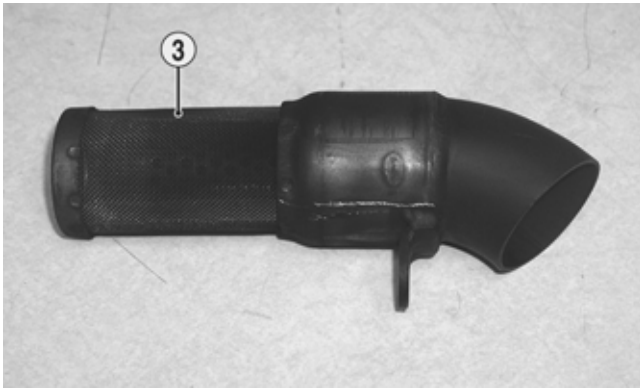

KM140B

3. Install the spark arrester and secure with the cap screw. Tighten securely.

Engine Oil — Filter

Replace the engine oil and clean the screen/filter at the scheduled intervals. The engine should always be warm when the oil is changed so the oil will drain easily and completely.

1. Park the ATV on level ground.
2. Loosen the oil fill plug.

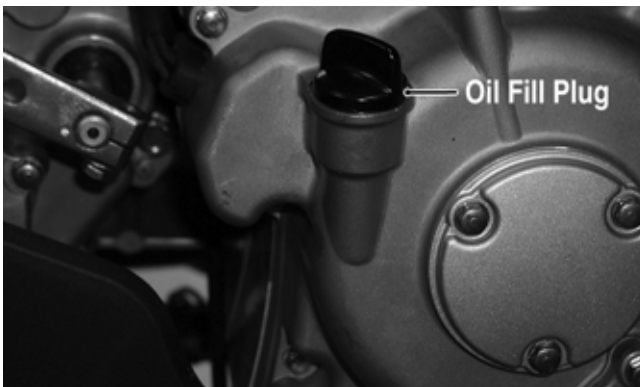

KM126A

3. Remove the oil drain plug and drain the oil.

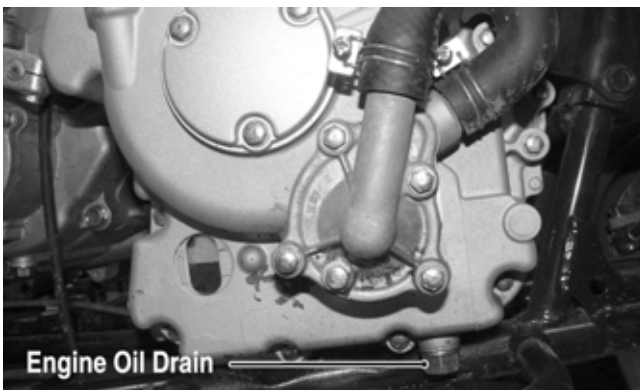

KM314B

4. Remove the screen/filter cap from the bottom of the engine and drain the oil into a drain pan. Account for a spring, O-ring, and screen/filter. Discard the O-ring.

WARNING

Use extreme caution when removing the oil drain plug. Hot oil can cause severe injury and skin burns.

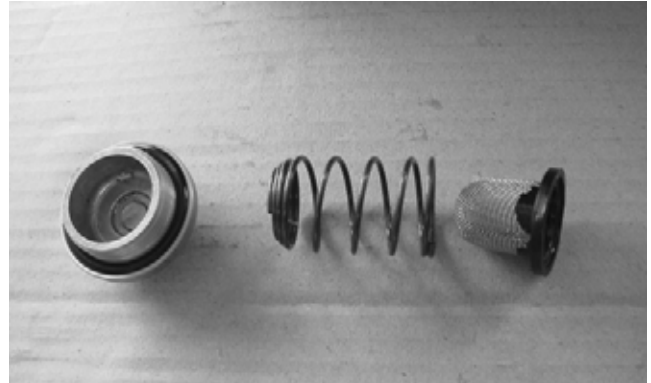

DSC02248

5. Clean the screen/filter in parts-cleaning solvent; then inspect the O-ring and replace if damaged.
6. Install the screen/filter, spring, new O-ring, and screen/filter cap into the bottom of the engine and tighten to 11 ft-lb (15 N-m).
7. Install the oil drain plug and tighten to 11 ft-lb (15 N-m).
8. Remove the oil fill plug and pour in 1.6 L (1.7 U.S. qt) of the recommended oil into the fill hole; then install the oil fill plug.

CAUTION

Any oil used in place of the recommended oil could cause serious engine damage. Do not use oils which contain graphite or molybdenum additives. These oils can adversely affect clutch operation. Also, not recommended are racing, vegetable, non-detergent, and castor-based oils.

9. Start the engine (while the ATV is outside on level ground) and allow it to idle for a few minutes.
10. Turn the engine off and wait approximately one minute. Check the oil level in the engine oil inspection window. The oil level should be visible through the window. If oil is not visible, add recommended oil until the oil level is visible between the lines of the window.

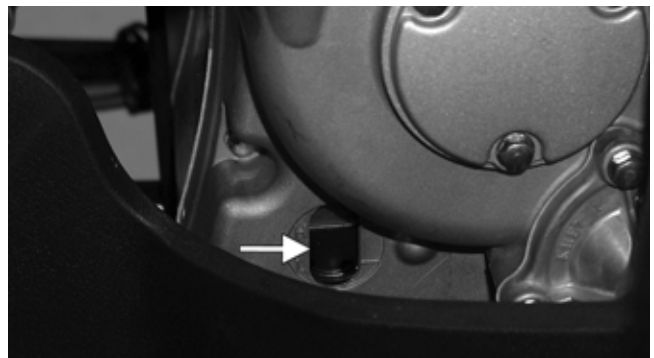

KM127A

11. Inspect the area around the screen/filter cap for leaks.

Rear Drive Lubricant

Check and change the lubricant according to the Periodic Maintenance Chart. When changing the lubricant, use approved SAE 80W-90 hypoid gear lube. To check lubricant, use the following procedure:

1. Remove the rear drive level plug; the lubricant level should be at the threads of the plug.

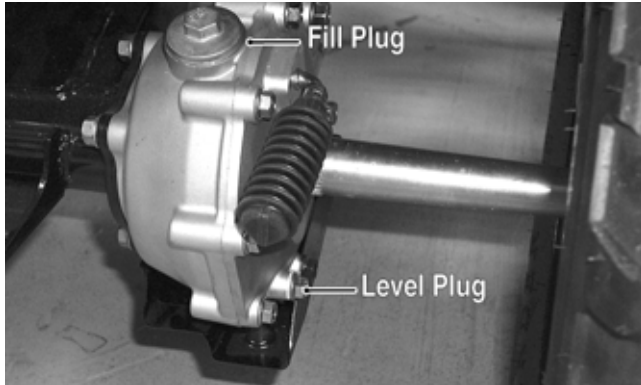

KM131A

2. If low, add SAE-approved 80W-90 hypoid gear lube as necessary.

To change the lubricant, use the following procedure:

1. Place the ATV on level ground.
2. Loosen the fill plug.
3. Remove the cap screws securing the rear drive gear guard; then remove the guard.
4. Drain the lubricant into a drain pan by removing the drain plug from the bottom of the rear drive.

■**NOTE:** If the rear drive lubricant is contaminated with water, inspect the drain plug, fill plug, and/or bladder.

5. After all the lubricant has been drained, install the drain plug and tighten securely. Install the rear drive gear guard and tighten the cap screws securely.
6. Pour the appropriate amount of recommended lubricant into the fill hole. Remove the level plug and check for appropriate level.
7. Install the fill plug.

CAUTION

Water entering the outer end of the axle will not be able to enter the rear drive unless the seals are damaged.

Transmission Lubricant

Change the lubricant according to the Periodic Maintenance Chart. When changing the lubricant, use approved SAE 80W-90 hypoid gear lube.

To change the lubricant, use the following procedure:

1. Place the ATV on level ground.
2. Loosen the fill plug; then remove the transmission drain plug and drain the transmission lubricant.

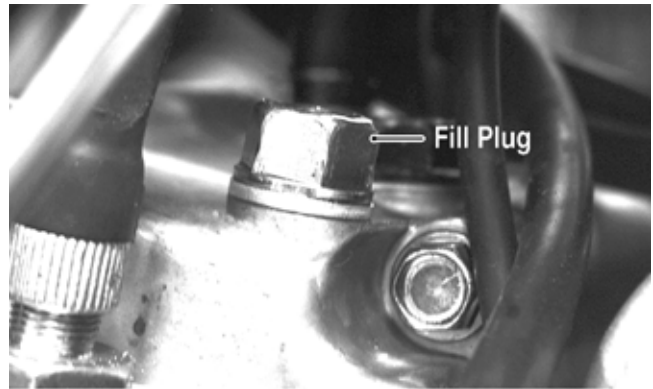

KM104A

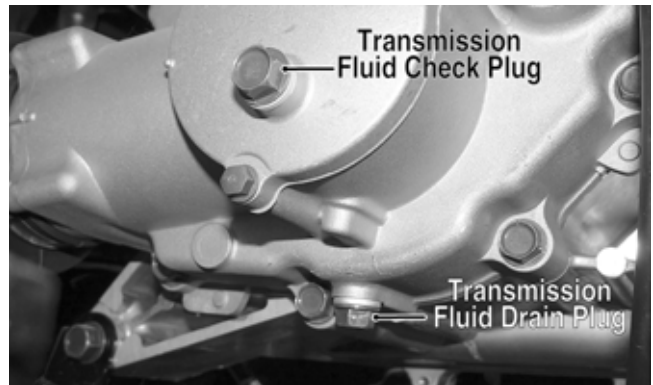

KM954A

3. Install the drain plug and tighten securely.
4. Remove the fill plug and pour the appropriate amount of recommended lubricant into the fill hole. The check plug may be used to verify fluid level.
5. Install the fill plug and tighten securely.
6. Check the area around the drain plug for leakage.

Driveshaft/Coupling

The following drive system components should be inspected periodically to ensure proper operation:

- A. Spline lateral movement (slop).
- B. Coupling not cracked, damaged, or worn.

Shift Lever



XA073A

CHECKING ADJUSTMENT

Stop the ATV completely and shift the transmission into the R position. The reverse gear indicator light should be illuminated.

WARNING

Never shift the ATV into reverse gear when the ATV is moving as it could cause the ATV to stop suddenly throwing the operator from the ATV.

If the reverse gear indicator light does not illuminate when shifted to the reverse position, the switch may be faulty, the fuse may be blown, the bulb may be faulty, a connection may be loose or corroded, or the lever may need adjusting. To adjust, proceed to Adjusting Shift Lever.

ADJUSTING SHIFT LEVER

1. Place the shift lever in the N (neutral) position; then set the engine stop switch to the STOP position and turn the ignition switch to the RUN position. The neutral indicator light should illuminate.

NOTE: If the neutral indicator light does not illuminate, adjustment of the shift linkage will be required. To adjust, proceed to step 2.

2. Loosen the jam nuts on both ends of the shift rod and turn the shift rod until the neutral light illuminates. Tighten the jam nuts securely.



KM313

Hydraulic Brake Systems

CHECKING FLUID/BLEEDING

The hydraulic brake systems have been filled and bled at the factory.

1. With the master cylinder in a level position, check the fluid level in the reservoir. If the level in the reservoir is not visible in the sight glass, add DOT 4 brake fluid.



XA074

2. Compress the brake lever/pedal several times to check for a firm brake. If the brake is not firm, the system must be bled.
3. To bleed the brake system, use the following procedure:
 - A. Remove the cover and fill the reservoir with DOT 4 Brake Fluid.
 - B. Install and secure the cover; then slowly compress the brake lever several times.
 - C. Remove the protective cap, install one end of a clear hose onto the REAR bleed screw, and direct the other end into a container; then while holding slight pressure on the brake lever, open the bleed screw and watch for air bubbles. Close the bleed screw before releasing the brake lever. Repeat this procedure until no air bubbles are present.

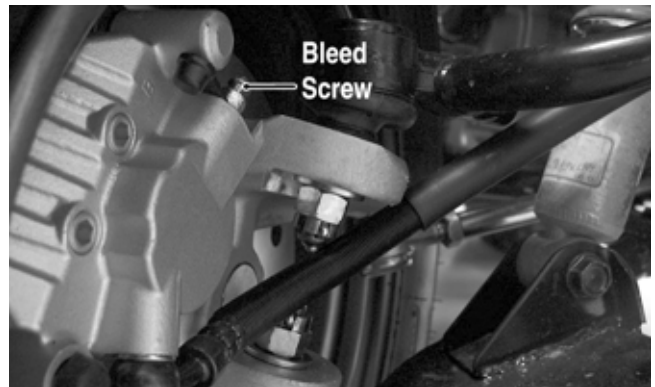

KM116A

NOTE: During the bleeding procedure, watch the reservoir sight glass very closely to make sure there is always a sufficient amount of brake fluid. Failure to maintain a sufficient amount of fluid in the reservoir will result in air in the system.

D. At this point, perform steps B and C on the FRONT RIGHT bleed screw; then move to the FRONT LEFT bleed screw and follow the same procedure.

4. Carefully check the entire hydraulic brake system that all hose connections are tight, the bleed screws are tight, the protective caps are installed, and no leakage is present.

CAUTION

This hydraulic brake system is designed to use DOT 4 brake fluid only. If brake fluid must be added, care must be taken as brake fluid is very corrosive to painted surfaces.

INSPECTING HOSES

Carefully inspect the hydraulic brake hoses for cracks or other damage. If found, the brake hoses must be replaced.

CHECKING/REPLACING FRONT PADS

The clearance between the brake pads and brake discs is adjusted automatically as the brake pads wear. Replace the brake pads when they show excessive wear and check the condition of the brake rotors. Replace as necessary. Check the thickness of each of the brake pads as follows:

1. Remove a front wheel.
2. Measure the thickness of each brake pad.
3. If thickness of either brake pad is less than 1.0 mm (0.039 in), the brake pad must be replaced.

■NOTE: The brake pads should be replaced as a set.

4. To replace the brake pads, use the following procedure:
 - A. With the wheel removed, remove the brake pad alignment pins from the caliper; then remove the mounting cap screws.

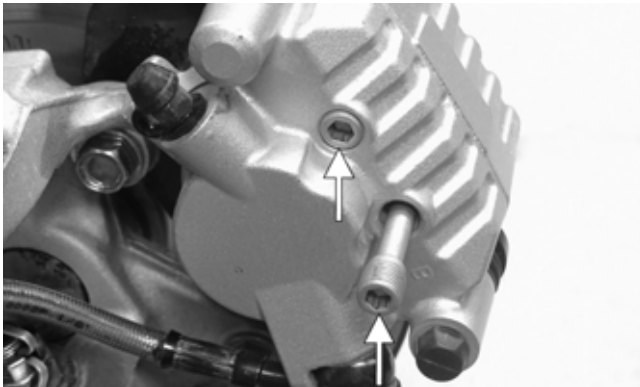

KM265A

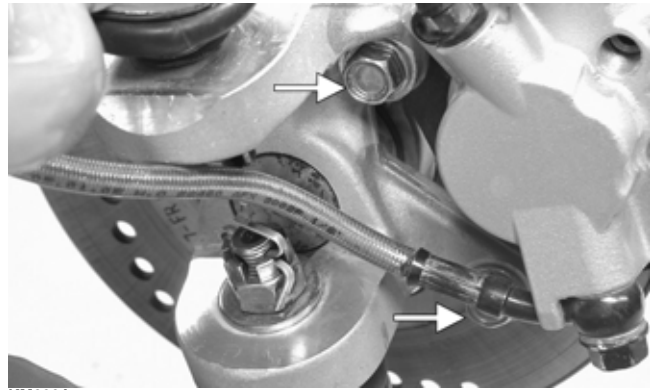

KM266A

- B. Remove the caliper from the disc; then compress the caliper holder and remove the brake pads.



KM267

- C. Install new brake pads; then install the two brake pad alignment pins.



KM268

- D. Spread the brake pads and place the brake caliper over the disc. Secure with the mounting cap screws. Tighten the cap screws to 25 ft-lb (34 N-m); then tighten the alignment pins to 13 ft-lb (17.7 N-m).

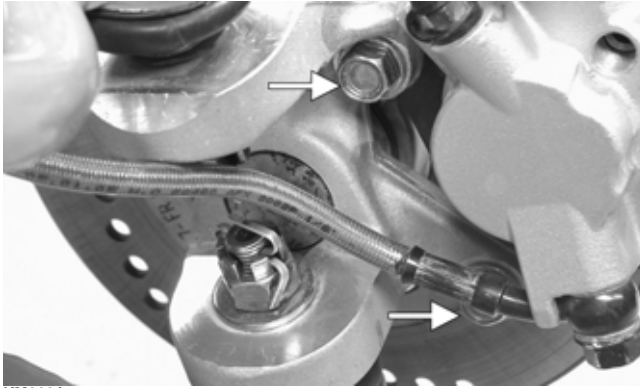

KM266A

5. Install the wheel. Tighten in a crisscross pattern to 40 ft-lb (54.4 N-m).
6. Burnish the brake pads (see Burnishing Brake Pads in this section).

CHECKING REAR HYDRALLIC BRAKE

1. With the engine off and the transmission in neutral, press the brake pedal and attempt to move the ATV.
2. If the rear wheels are locked, it is functioning properly.
3. If the rear wheels are not locked, it must be repaired or bled.

CHECKING/REPLACING REAR BRAKE PADS

Removing

1. Support the ATV on a suitable support stand.
2. Remove the left rear wheel.
3. Remove the two brake pad alignment pins (A); then remove the mounting cap screws (B).

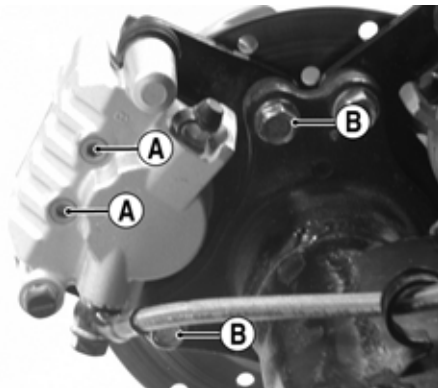

KM273A

4. Remove the caliper from the disc; then compress the caliper holder and remove the brake pads.

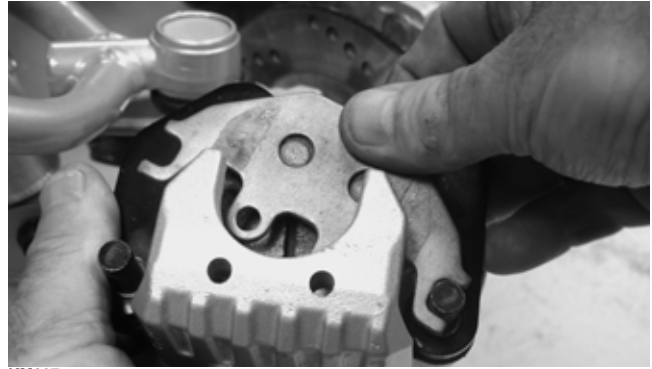

KM267

Inspecting and Measuring

1. Inspect the pads for gouges, chips, or wear.
2. Inspect the disc for gouges, grooves, cracks, and warpage.
3. Using a calipers, measure the thickness of each brake pad.
4. If the thickness of either brake pad is less than 1.0 mm (0.039 in), the brake pad must be replaced.

■NOTE: The brake pads should be replaced as a set.

Installing

1. Install new brake pads; then install the two brake pad alignment pins.
2. Spread the brake pads and place the brake caliper over the disc; then secure with the mounting cap screws (B). Tighten the cap screws to 25 ft-lb (34 N-m); then tighten the alignment pins (A) to 13 ft-lb (17.7 N-m).

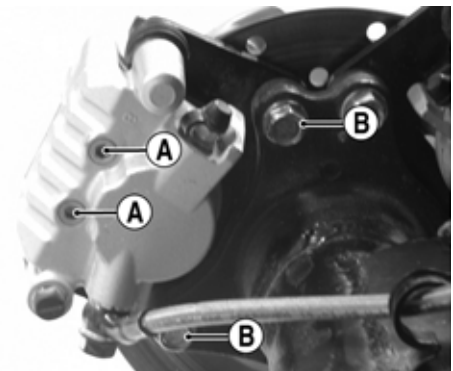

KM273A

3. Install the wheel. Tighten in a crisscross pattern to 40 ft-lb (54.4 N-m).
4. Remove the ATV from the support stand.

■NOTE: Whenever installing new pads, the new pads must be burnished (see Burnishing Brake Pads in this section).

Burnishing Brake Pads

Brake pads (both hydraulic and auxiliary) must be burnished to achieve full braking effectiveness. Braking distance will be extended until brake pads are properly burnished. To properly burnish the brake pads, use the following procedure:

WARNING

Failure to properly burnish the brake pads could lead to premature brake pad wear or brake loss. Brake loss can result in severe injury or death.

1. Choose an area large enough to safely accelerate the ATV to 30 mph and to brake to a stop.
2. Accelerate to 30 mph; then release the throttle and compress brake lever or apply the auxiliary brake to decelerate to 0-5 mph.
3. Repeat procedure on each brake system five times until brake pads are burnished.
4. Adjust the auxiliary brake (if necessary).
5. Verify that the brake light illuminates when the hand lever is compressed or the brake pedal is depressed.

Checking/Replacing V-Belt

REMOVING

1. Remove the left footwell; then remove the recoil starter assembly.

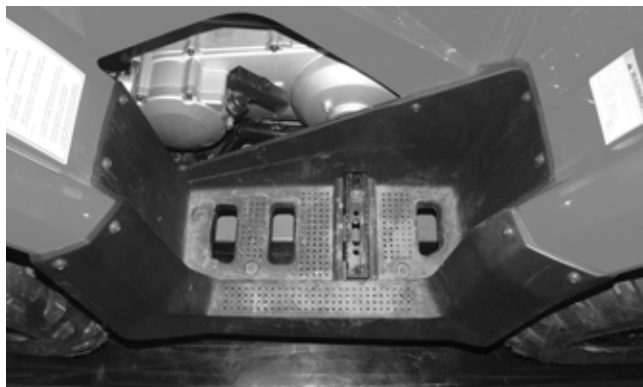

XA064

2. Remove the front and rear V-belt housing cooling ducts.
3. Remove the cap screws securing the V-belt cover noting the location of the different-length cap screws for installing purposes; then using a rubber mallet, gently tap on the cover tabs to loosen the cover. Remove the cover. Account for two alignment pins and one gasket.

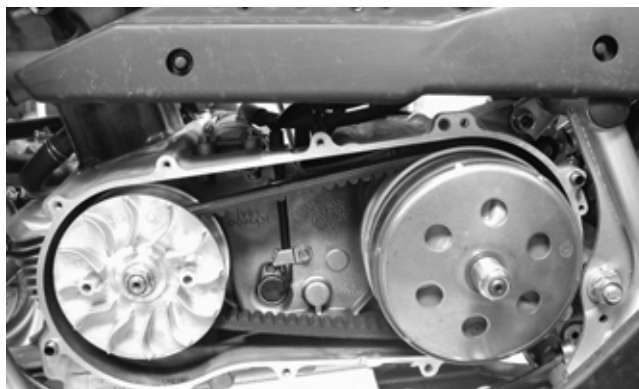

KM253

4. Remove the nut securing the movable drive face; then remove the face. Account for the stepped washer and spacer.



KM276

5. Remove the nut securing the driven pulley; then remove the splined bushing, centrifugal clutch, pulley, and V-belt.

CHECKING

Use the Drive Belt Gauge to identify any abnormal wear. Measure across the top of the V-belt (in multiple locations) using a Vernier caliper. Do not squeeze the belt as doing so may produce an inaccurate measurement. The V-belt must be at least 1.1 in (28.5 mm) at any point.

INSTALLING

1. Using a rubber mallet, spread the driven pulley sheaves by driving the V-belt down between the sheaves; then slide the driven pulley and V-belt into position.



KM262

2. Install the centrifugal clutch housing onto the driven shaft; then install the splined bushing and secure with the driven pulley retaining nut. Tighten to 40 ft-lb (54.4 N-m).



KM276

3. Install the movable drive face onto the crankshaft making sure to “bottom” the sheave out against the center bushing. The crankshaft splines should be visible and the stepped washer should sit over the splines.

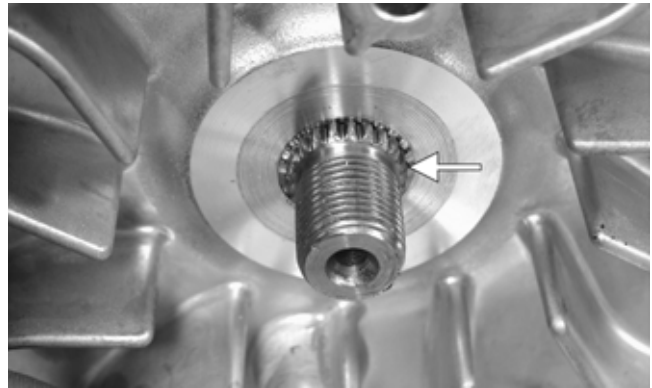

KM263A

CAUTION

If the splines are not protruding as shown, the V-belt may be too deep in the drive sheaves. This would cause the drive pulley to be under-tightened and severe drive sheave or crankshaft damage could occur.

4. Secure the movable drive face to the crankshaft with the drive pulley nut and tighten to 72 ft-lb (97.9 N-m).
5. Install the V-belt cover and tighten the cap screws securely; then connect the cooling boots and tighten the clamps securely.
6. Install the recoil starter and footwell assembly. Tighten all hardware securely.

Steering/Body/Controls

The following steering components should be inspected periodically to ensure safe and proper operation:

- A. Handlebar grips not worn, broken, or loose.
- B. Handlebar not bent or cracked and has equal and complete full-left and full-right turning capability.
- C. Steering post bearing assembly/bearing housing not broken, worn, or binding.
- D. Ball joints not worn, cracked, or damaged.
- E. Tie rods not bent or cracked.
- F. Knuckles not worn, cracked, or damaged.
- G. Cotter pins not damaged or missing.

The frame, welds, and racks should be checked periodically for damage, bends, cracks, deterioration, broken components, and missing components.

Front Rack/Body Panel/Fender

REMOVING

1. Remove the seat.
2. Release both headlight connectors from the frame; then disconnect the headlight connectors from the main harness.

■**NOTE:** Use a small screwdriver to disengage the tab connector allowing the connector assembly to be removed from the frame.

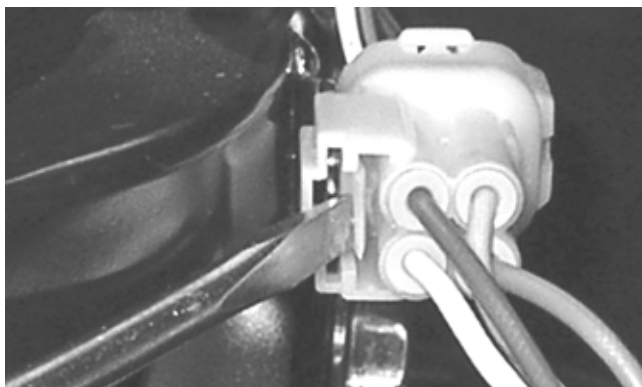

KC223

3. Remove the Phillips-head screws securing the front rack over-mold to the rack; then remove the four cap screws securing the rack to the frame.



XA002

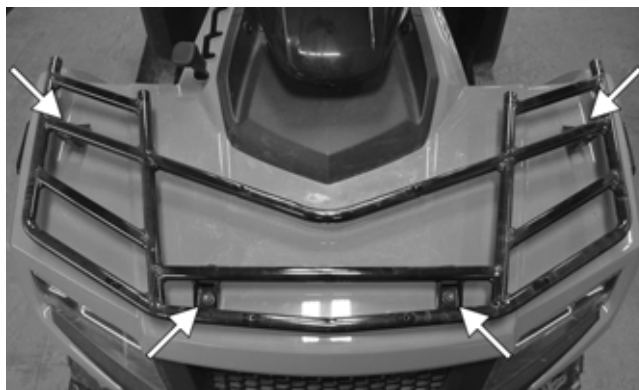

XA061A

4. Remove the two reinstallable rivets securing the steering post cover; then remove the cover.



XA062A

5. Remove the gas tank cap and two reinstallable rivets securing the gas tank cover. Slide the cover forward to remove.



XA063

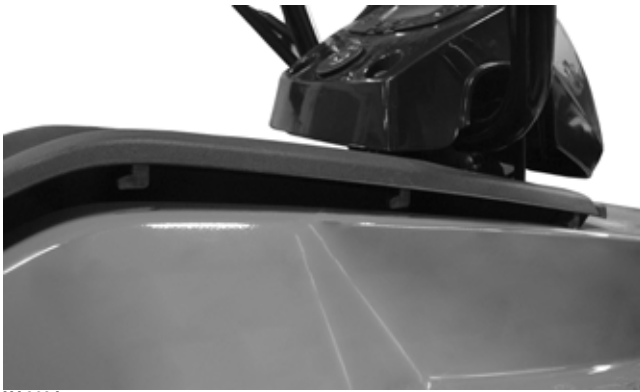

XA069A

6. Remove the Phillips-head screws with lock nuts and three cap screws securing each footwell to the vehicle. Remove the footwells.

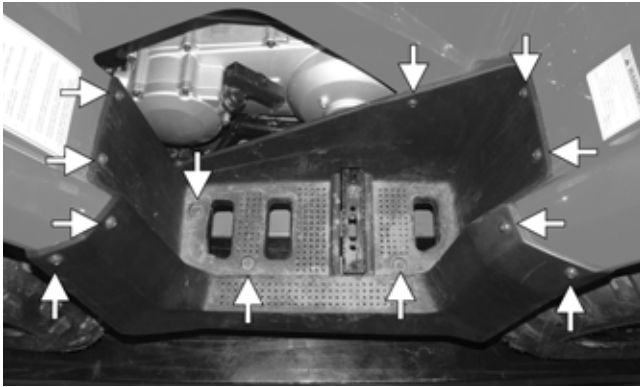

XA064A

7. Remove the four cap screws securing the rear section of the front body panel to the frame; then remove the two cap screws securing the body panel to the gas tank.

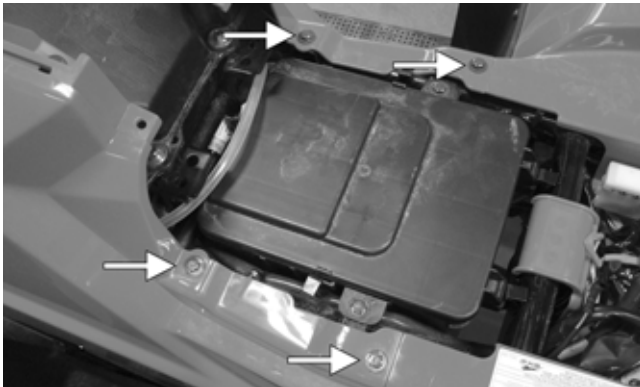

XA065A



XA066

8. Remove the two self-tapping screws securing the inlet of the CVT intake tube to the front body panel.



XA067

9. From within the front fascia, remove the two cap screws securing the fascia to the front bumper. From the front of the vehicle, remove the two cap screws securing the front of the fascia to the bumper.



XA068A



XA070

10. Remove the Allen-head screw securing the shift knob to the shift lever. Turn the steering wheel full left and remove the front body panel.



XA071

CLEANING AND INSPECTING

1. Clean all body components with soap and water.
2. Inspect the body and fenders for cracks.
3. Inspect threaded areas of all mounting studs for stripping.
4. Inspect for missing decals.

INSTALLING

1. Place the front panel assembly onto the frame. Loosely install the four cap screws located under the seat.

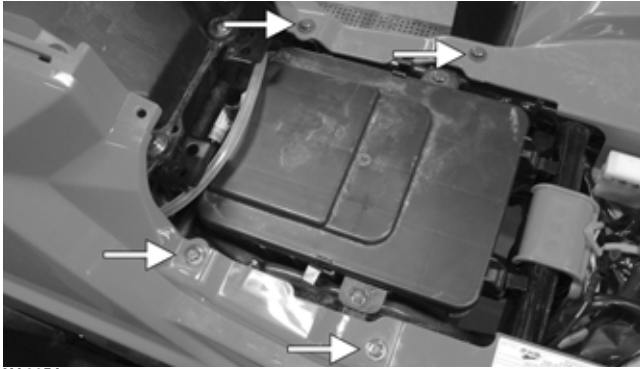

XA065A

2. Secure the two cap screws securing the lower fascia to the front bumper; then from within the front bumper assembly, secure the additional two cap screws to the frame. Tighten the cap screws from step 1.



XA070



XA068A

3. Secure the shift knob to the shift lever using the Allen-head screw. Secure the CVT intake tube using the two machine screws. Connect each headlight connector; then secure the connectors to the frame via the locking tabs.

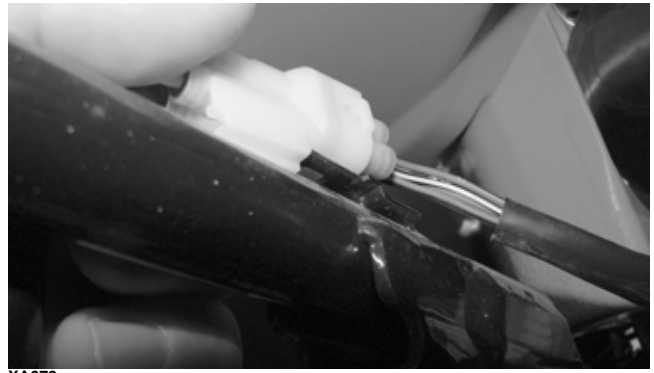

XA072

4. Secure the front body panel to the gas tank; then install both footwells.



XA066

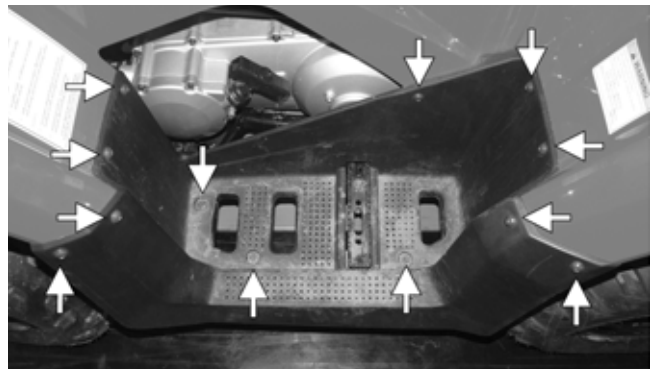

XA064A

5. Install the gas tank cover making sure the locating tabs properly align with and engage the front body panel. Secure the gas tank cover with the two re-installable rivets. Install and secure the steering post cover.
6. Place the front rack into position and secure using the four cap screws. Install the front over-mold onto the front rack using the self-tapping screws.

Front Fascia/Headlight

REMOVING

1. Release each locking tab securing each headlight connector to the frame; then disconnect each connector.



XA072

2. Remove the cap screws securing each headlight assembly to the front fascia and front body panel. Remove the headlights.

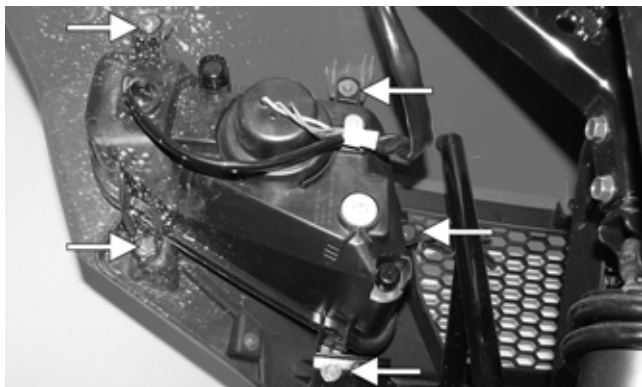

XA082A

3. From the front of the vehicle, remove the two cap screws securing the lower portion of the fascia to the front bumper.



XA070

4. From within the front body panel, remove the remaining five cap screws securing the front fascia to the front body panel. Remove the fascia.



XA083A

CLEANING AND INSPECTING

1. Clean the fascia and related components with soap and water.
2. Inspect the fascia and fenders for cracks.
3. Inspect threaded areas of all mounting studs for stripping.
4. Inspect for missing decals.

INSTALLING

1. Place the front fascia into the front body panel and secure it using the five cap screws in the locations shown. From the front of the fascia, install and secure the two lower cap screws connecting to the bumper.



XA083A

2. Install both headlights assemblies; then connect each connector to the main wire harness connectors. Secure each connector to the frame.

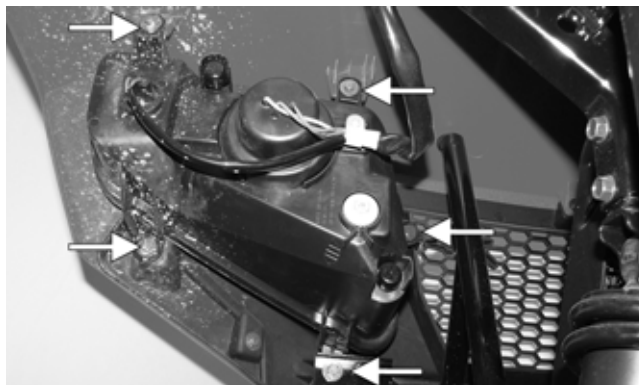

XA082A



XA072

Rear Rack/Body Panel/Fender

REMOVING

1. Remove the seat, steering post cover, gas tank cover, battery, and both left and right footwells.

■NOTE: When disconnecting the battery, disconnect the negative cable first, then the positive cable.

2. Disconnect the green ground wire (A) and starter relay primary connector (B). Remove the SIG relay (C) and starter relay from the rear body panel. Using a flat blade screwdriver, lightly pry against the PDM locking tab (D) to release the PDM from the rear body panel.

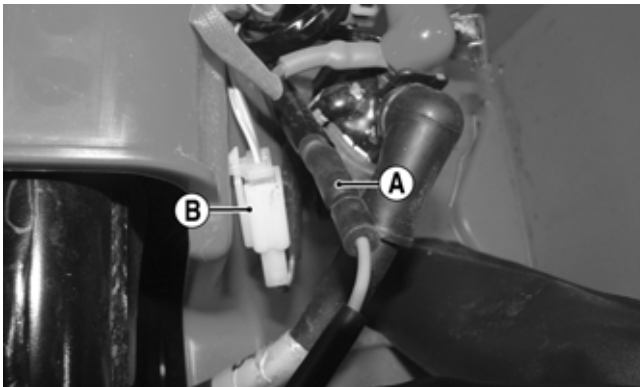

XA076A

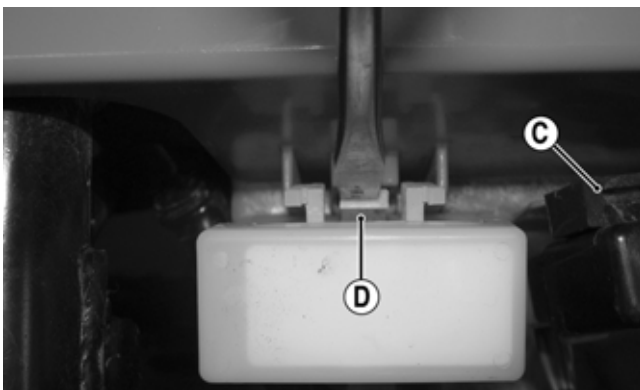

XA078A

3. Remove the six cap screws securing the front body panel to the frame and gas tank. Pull the front body panel out and away from the frame.

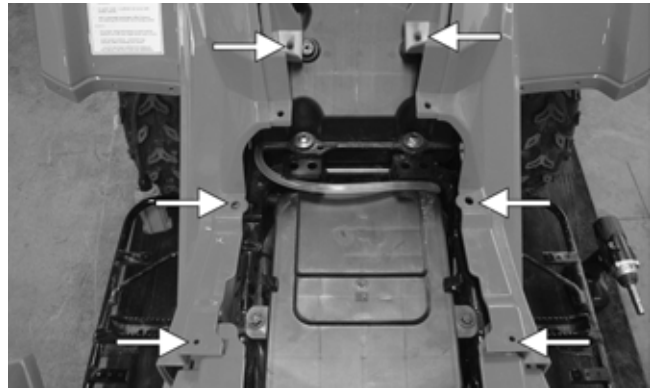

XA077A

4. Remove the self-tapping screws securing the rear over-mold to the rear rack; then remove the four cap screws securing the rear rack to the frame. Remove the rack. Account for the four steel inserts installed into each rubber grommet.

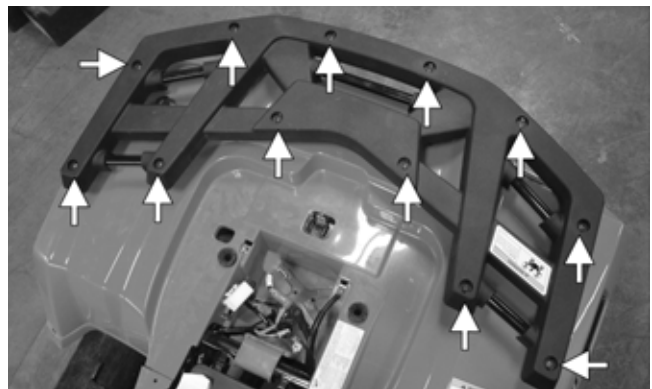

XA080A

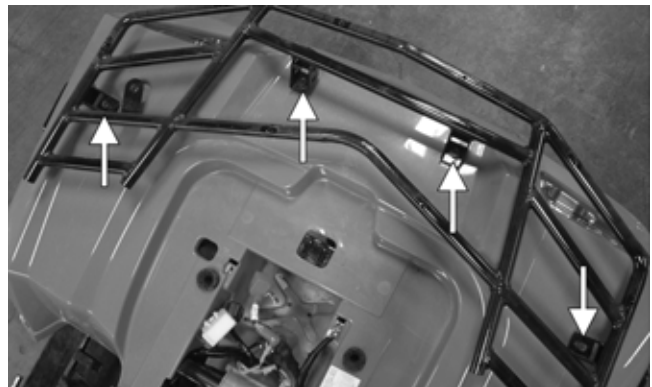

XA081A

5. Located under the left rear fender, loosen the clamp securing the two halves of the CVT outlet pipe. Disconnect the two halves.

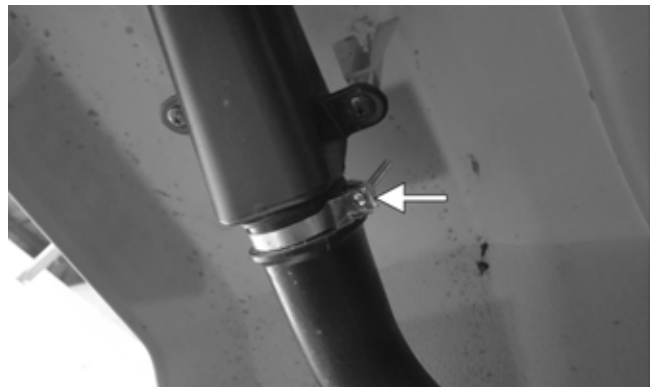

XA079A

- Using a flat blade screwdriver, release the connector locking tabs; then disconnect the tail light/brake light connectors.

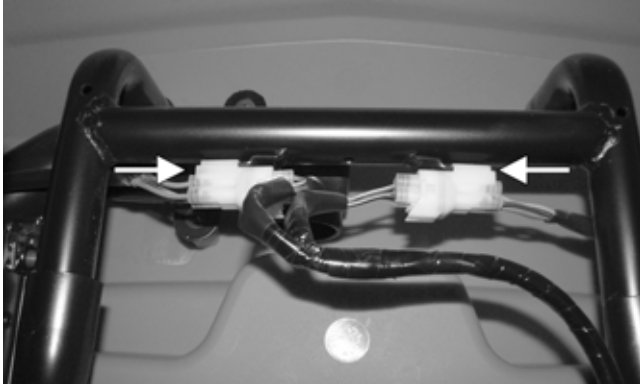

XA084A

- Remove the four cap screws securing each tail light/brake light assembly to the rear body panel assembly. Remove the tail light/brake light assemblies.

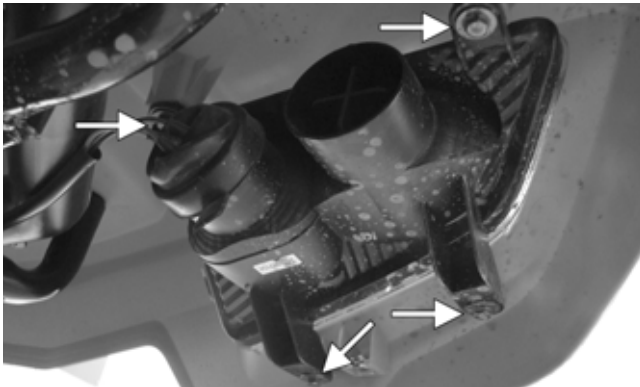

XA085A

- Remove the rear body panel assembly.

CLEANING AND INSPECTING

- Clean all body components with soap and water.
- Inspect the body and fenders for cracks.
- Inspect threaded areas of all mounting studs for stripping.
- Inspect for missing decals.

INSTALLING

- Place the rear body panel into position on the frame while guiding the SIG relay, starter relay, and PDM through the front of the body panel. Secure the two halves of the CVT outlet tubes together with the clamp.
- With the four steel inserts installed into each rubber grommet, place the rear rack into position and secure with the four cap screws.
- Place the rear over-mold atop the rear rack and secure it using the self-tapping screws.

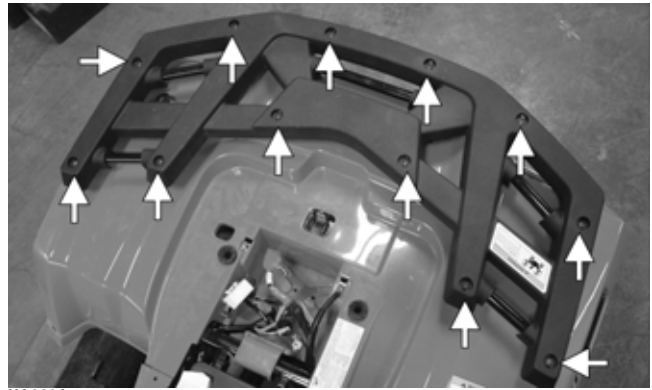

XA080A

- Install the six cap screws securing the front body panel to the frame, gas tank, and rear body panel; then install and secure the gas tank cover and steering post covers using the plastic reinstallable rivets.

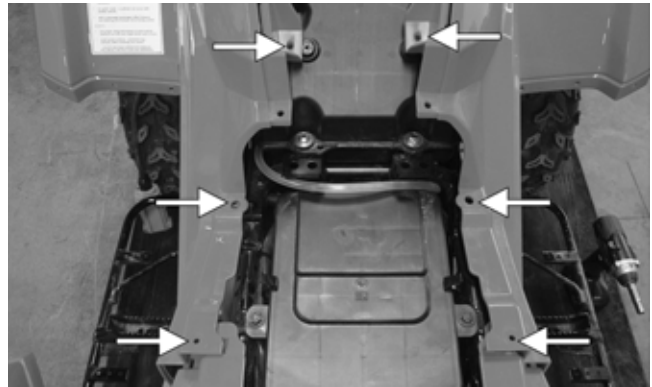

XA077A

- Place the PDM, SIG relay, and starter relay into their respective positions within the battery tray. Ensure the PDM locks into place. Connect the starter relay primary connector (B) and green ground wire connector (A).

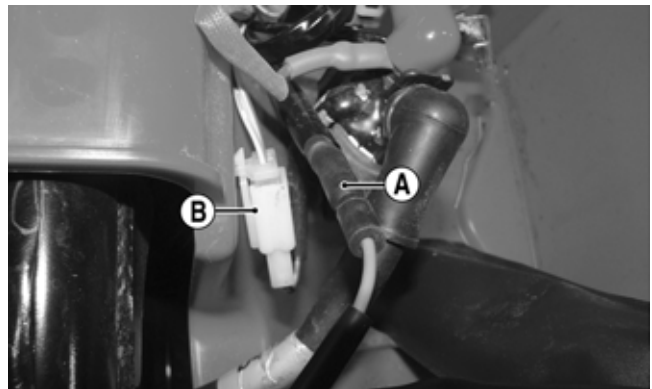

XA076A

- Place each tail light/brake light assembly into place and secure with the cap screws. Connect each wire connector to the main harness; then secure to the frame.

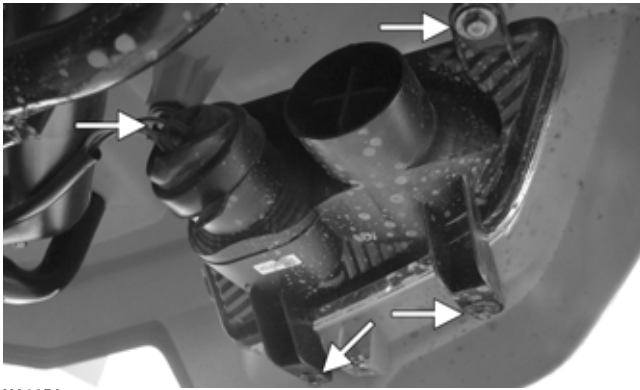

XA085A

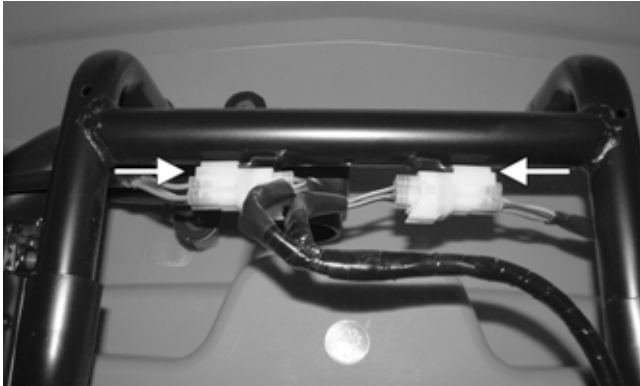

XA084A

7. Install and secure both footwells. Place the battery into the tray and secure it with the battery bracket. Connect the battery cables. Install the seat.

■**NOTE:** When connecting the battery cables, connect the positive cable first, then the negative cable.

Steering Post Cover/Instrument Pod

REMOVING

1. Remove the reinstallable rivet on the front of the instrument pod and the two cap screws on the rear; then lift the assembly off and disconnect the speedometer cable.
2. Remove the self-tapping screw securing the LCD gauge assembly to the instrument pod; then remove the LCD gauge.

■**NOTE:** The LCD gauge is not a serviceable component. If any functions are incorrect or indicator lights do not illuminate, the LCD gauge must be replaced.

INSPECTING

The LCD gauge is not a serviceable component. To inspect the LCD gauge, see Electrical System.

INSTALLING

1. Connect the main harness connector to the LCD gauge; then connect the ignition harness to the ignition connectors.
2. Place the instrument pod onto the mounting bracket; then secure with the reinstallable rivet and two cap screws.

Steering Post/Tie Rods

REMOVING

1. Remove the steering post cover.
2. Remove the instrument pod; then remove the cap screws securing the handlebar to the steering post. Account for two handlebar holders.

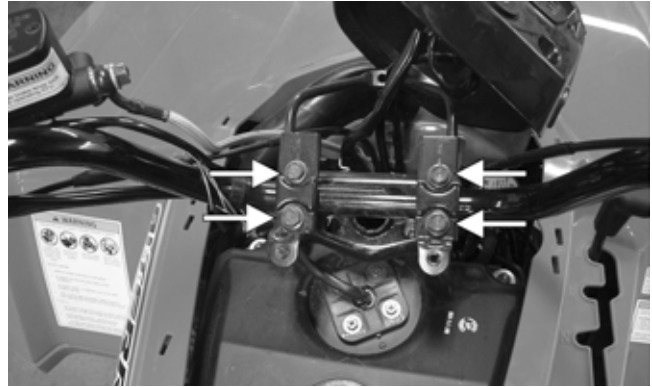

XA075A

3. Lift the handlebar out of the lower handlebar holders and lay the handlebar forward.
4. Remove the cotter pins and slotted nuts securing the tie rod ends to the steering post arm; then disconnect the tie rods from the arm.



KM590

5. Remove the cotter pin and slotted nut from the lower end of the steering post; then remove the upper steering shaft support block. Account for a cable guide, two steering support blocks, and the upper steering post bushing.

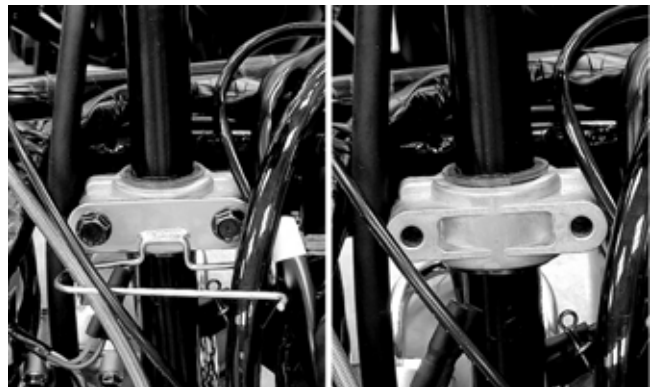

KM588

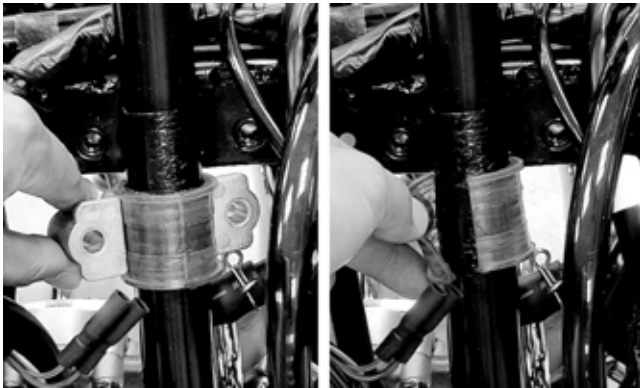

KM589

6. Remove the steering post from the ATV.

CLEANING AND INSPECTING

1. Wash the tie rod ends in parts-cleaning solvent. Dry with compressed air. Inspect the pivot area for wear. Apply a low-temperature grease to the ends.

WARNING

Always wear safety glasses when using compressed air.

2. Inspect the tie rods for damaged threads or wear.
3. Inspect the tie rods for cracks or unusual bends.
4. Inspect all welded areas for cracks or deterioration.
5. Inspect the steering post and steering-post holders for cracks, bends, or wear.
6. Inspect the handlebar clamps for cracks or wear.
7. Inspect the handlebar for cracks, wear, or unusual bends.
8. Inspect the handlebar grips for damage or wear.
9. Inspect the lower steering post support bearing and seal for wear or cracks.

INSTALLING

1. Apply a thin coat of grease to the lips of the lower steering post seals; then lower the steering post into position in the lower steering post bearings.



KM593

2. Apply a thin coat of grease to the upper steering post bushing; then secure the steering post with the support blocks and existing hardware. Tighten to 17 ft-lb (23.1 N-m).



KM589

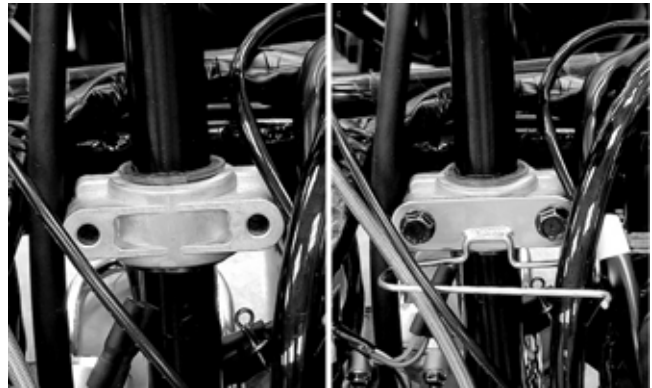

KM595

3. Install the slotted nut on the lower steering post and tighten to 50 ft-lb (68 N-m); then install a new cotter pin.



KM591

4. Place the inner tie rod ends into the steering post arm and tighten the slotted nuts to 15 ft-lb (20.4 N-m); then install new cotter pins.



KM590

5. Install the handlebar and tighten the clamp cap screws to 18 ft-lb (24.5 N-m) making sure to tighten the front cap screws first.

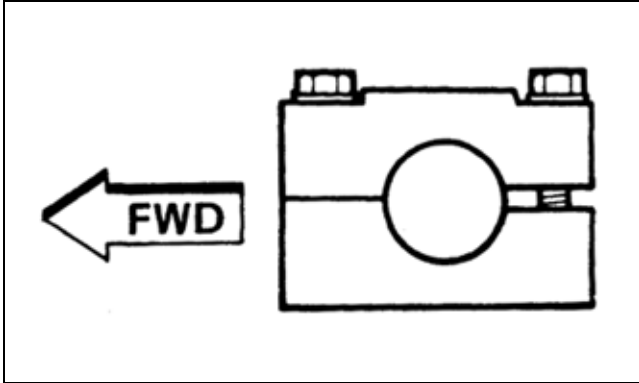

KM587



KM597

6. Install the instrument pod.
7. Install the steering post cover.

Front Wheel Alignment

1. With the ATV on a level surface, center the handlebar for straight ahead using a suitable means of measuring centering; then adjust tire pressure to specifications (see General Information/Foreword — Specifications).
2. Support the front of the ATV with the wheels free to rotate; then center and secure the handlebar.
3. Measure the distance (A) and (B) between the front wheels; then subtract distance (B) from (A). Distance $A - \text{Distance } B = \text{Toe-In}$.

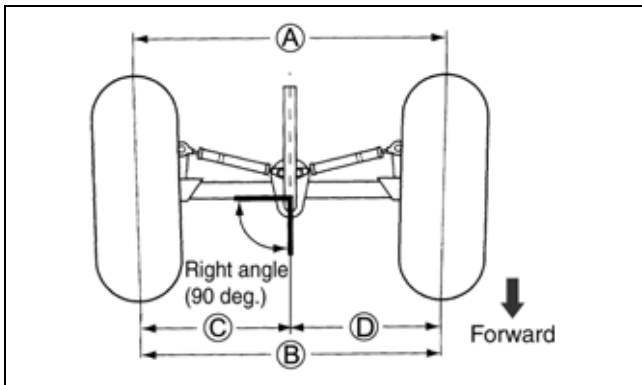

ATV2205

4. Adjust toe-in to 15 mm (0.60 in); then measure distances (C) and (D). Distances (C) and (D) should be equal.
5. After all the adjustments are to specifications, tighten the tie-rod lock nuts to 15 ft-lb (20.4 N-m).

■NOTE: Prior to locking the jam nuts, make sure the ball joints are at the center of their normal range of motion and at the correct angle.

■NOTE: The front wheels do not have to be removed to adjust the tie rod. Also, care should be taken not to disturb the handlebar position.

Throttle Control

REMOVING

1. Remove the boot from the throttle cable adjuster; then loosen the jam nut and turn the adjuster completely in to loosen the cable.
2. Remove the three machine screws securing the cover to the throttle control; then remove the cover and disengage the throttle cable from the throttle arm.
3. Turn the cable adjuster out of the throttle control housing; then remove the two machine screws securing the throttle control to the handlebar and remove the throttle control.

INSTALLING

1. Making sure the throttle housing upper flat aligns with the alignment mark on the handlebar, place the throttle control into position on the handlebar and secure with the two machine screws; then tighten the machine screws securely.



KM122B

2. Thread the throttle cable into the throttle housing and turn the adjuster completely in; then connect the throttle cable to the throttle arm.
3. Install the throttle housing cover; then adjust the throttle cable (see Fuel/Lubrication/Cooling — Throttle Cable Free-Play).

Headlight — Taillight/Brake Light

Turn the ignition switch to the LIGHTS position; the headlights and taillight should illuminate. Test the brake light by compressing the brake lever. The brake light should illuminate.

■**NOTE:** The bulb portion of the headlight is fragile. **HANDLE WITH CARE.** When replacing the headlight bulb, do not touch the glass portion of the bulb. If the glass is touched, it must be cleaned with a dry cloth before installing. Skin oil residue on the bulb will shorten the life of the bulb.

⚠ WARNING

Do not attempt to remove the bulb when it is hot. Severe burns may result.

To replace the headlight bulb, use the following procedure:

1. Remove the rubber boot from the back of the headlight housing; then remove the three-wire connector from the bulb.



XA057

2. Press forward then up on the spring clip and swing the spring clip away from the bulb; then remove the bulb from the housing.



XA058A

3. Install the new bulb into the housing; then secure with the spring clip.

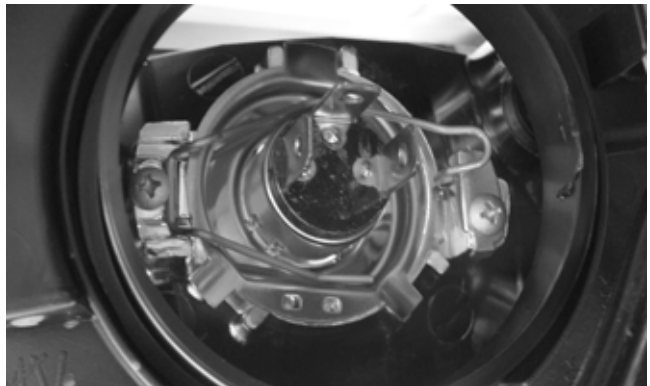

XA058

4. Connect the three-wire connector to the bulb; then install the rubber boot.

CAUTION

When replacing the headlight bulb, be careful not to touch the glass portion of the bulb. Grasp the new bulb with a clean cloth.

To replace the front running light bulbs, use the following procedure:

Rotate the bulb socket counterclockwise to remove from the headlight housing, account for the seal. Carefully pull the bulb away from the socket.

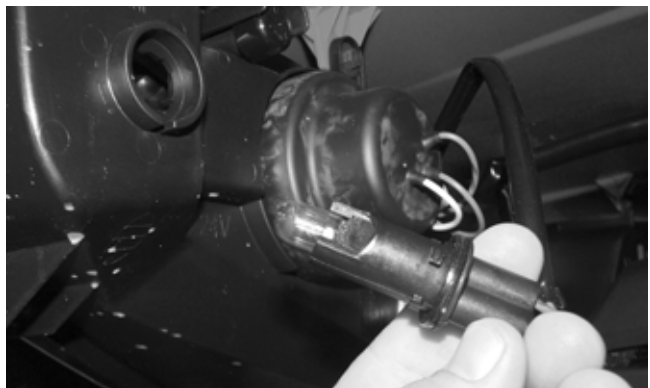

XA059

To replace the taillight/brake light bulb, use the following procedure:

1. Pull the rubber boot away; then rotate the socket counterclockwise to access the bulb. Account for the seal.

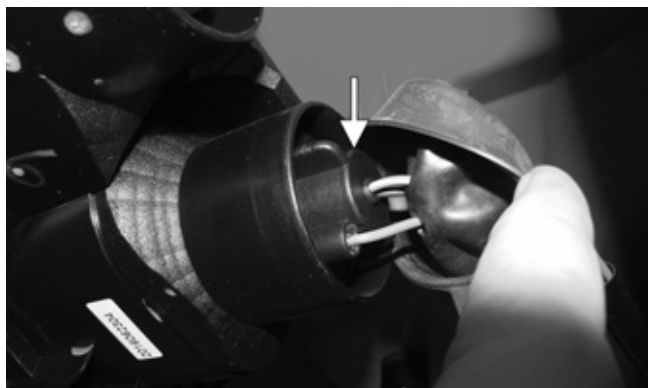

XA056A

2. To remove the bulb, push the bulb in and turn it counterclockwise.
3. Install the new bulb by turning it clockwise while pushing in.
4. Insert the socket into the taillight housing; then rotate the socket clockwise to secure.

Troubleshooting

Problem: Handling too heavy or stiff	
Condition	Remedy
<ol style="list-style-type: none"> 1. Front wheel alignment incorrect 2. Lubrication inadequate 3. Tire inflation pressure incorrect 4. Tie rod ends seizing 5. Linkage connections seizing 	<ol style="list-style-type: none"> 1. Adjust alignment 2. Lubricate appropriate components 3. Adjust pressure 4. Replace tie rod ends 5. Repair — replace connections
Problem: Steering oscillation	
Condition	Remedy
<ol style="list-style-type: none"> 1. Tires inflated unequally 2. Wheel(s) wobbly 3. Wheel hub cap screw(s) loose — missing 4. Wheel hub bearing worn — damaged 5. Tie rod ends worn — loose 6. Tires defective — incorrect 7. A-arm bushings damaged 8. Bolts — nuts (frame) loose 	<ol style="list-style-type: none"> 1. Adjust pressure 2. Replace wheel(s) 3. Tighten — replace cap screws to specified torque 4. Replace bearing 5. Replace — tighten tie rod ends 6. Replace tires 7. Replace bushings 8. Tighten bolts — nuts
Problem: Steering pulling to one side	
Condition	Remedy
<ol style="list-style-type: none"> 1. Tires inflated unequally 2. Front wheel alignment incorrect 3. Wheel hub bearings worn — broken 4. Frame distorted 5. Shock absorber defective 	<ol style="list-style-type: none"> 1. Adjust pressure 2. Adjust alignment 3. Replace bearings 4. Repair — replace frame 5. Replace shock absorber
Problem: Steering impaired	
Condition	Remedy
<ol style="list-style-type: none"> 1. Tire pressure too high 2. Steering linkage connections worn 3. Cap screws (suspension system) loose 	<ol style="list-style-type: none"> 1. Adjust pressure 2. Replace connections 3. Tighten cap screws to specified torque
Problem: Tire wear rapid or uneven	
Condition	Remedy
<ol style="list-style-type: none"> 1. Wheel hub bearings worn — loose 2. Front wheel alignment incorrect 	<ol style="list-style-type: none"> 1. Replace bearings 2. Adjust alignment
Problem: Steering noise	
Condition	Remedy
<ol style="list-style-type: none"> 1. Cap screws — nuts loose 2. Wheel hub bearings broken — damaged 3. Lubrication inadequate 	<ol style="list-style-type: none"> 1. Tighten cap screws — nuts to specified torque 2. Replace bearings 3. Lubricate appropriate components

Engine/Transmission

This section has been organized into sub-sections which show a progression for the complete servicing of the ATV engine/transmission.

To service the center crankcase halves, the engine/transmission must be removed from the frame.

To service top-side, left-side, and right-side components, the engine/transmission does not have to be removed from the frame.

■NOTE: The manufacturer recommends the use of new gaskets, lock nuts, and seals and lubricating all internal components when servicing the engine/transmission.

■NOTE: A new ATV and an overhauled ATV engine require a “break-in” period. The first 10 hours (or 200 miles) are most critical to the life of this ATV. Proper operation during this break-in period will help ensure maximum life and performance from the ATV. Instruct the customer to follow the proper break-in procedure as described in the Operator’s Manual.

SPECIAL TOOLS

A number of special tools must be available to the technician when performing service procedures in this section. Refer to the current Special Tools Catalog for the appropriate tool description.

■NOTE: When indicated for use, each special tool will be identified by its specific name, as shown in the chart below, and capitalized.

Description	p/n
Crankcase Separator/Crankshaft Remover	0444-152
Piston Pin Puller	0644-328
Spanner Wrench	0444-192
Flywheel Holder	0444-193
Magneto Rotor Remover	0444-187
Tappet Adjuster	0444-189
Surface Plate	0644-016
Driven Pulley Compressor	0444-195
V Blocks	0644-535

■NOTE: Special tools are available from the Service Parts Department.

Troubleshooting

Problem: Engine will not start or is hard to start (Compression too low)	
Condition	Remedy
<ol style="list-style-type: none"> 1. Valve clearance out of adjustment 2. Valve guides worn — seated poorly 3. Valves mistimed 4. Piston rings worn excessively 5. Cylinder bore worn 6. Spark plug seating poorly 7. Starter motor cranks too slowly — does not turn 	<ol style="list-style-type: none"> 1. Adjust clearance 2. Repair — replace guides 3. Adjust valve timing 4. Replace rings 5. Replace cylinder 6. Tighten plug 7. See Electrical System
Problem: Engine will not start or is hard to start (No spark)	
Condition	Remedy
<ol style="list-style-type: none"> 1. Spark plug fouled 2. Spark plug wet 3. Magneto defective 4. CDI unit defective 5. Ignition coil defective 6. High-tension lead open — shorted 	<ol style="list-style-type: none"> 1. Clean — replace plug 2. Clean — dry plug 3. Replace magneto 4. Replace CDI unit 5. Replace ignition coil 6. Replace high tension lead
Problem: Engine will not start or is hard to start (No fuel reaching the carburetor)	
Condition	Remedy
<ol style="list-style-type: none"> 1. Gas tank cap obstructed 2. Carburetor inlet needle defective 3. Fuel hose obstructed 4. Fuel screens obstructed 	<ol style="list-style-type: none"> 1. Clean or replace cap 2. Replace needle 3. Clean — replace hose 4. Clean — replace inlet screen — valve screen
Problem: Engine stalls easily	
Condition	Remedy
<ol style="list-style-type: none"> 1. Spark plug fouled 2. Magneto defective 3. CDI unit defective 4. Carburetor jets obstructed 5. Valve clearance out of adjustment 	<ol style="list-style-type: none"> 1. Clean plug 2. Replace magneto 3. Replace CDI unit 4. Clean jets 5. Adjust clearance
Problem: Engine noisy (Excessive valve chatter)	
Condition	Remedy
<ol style="list-style-type: none"> 1. Valve clearance too large 2. Valve spring(s) weak — broken 3. Rocker arm — rocker arm shaft worn 4. Camshaft worn 	<ol style="list-style-type: none"> 1. Adjust clearance 2. Replace spring(s) 3. Replace arm — shaft 4. Replace camshaft
Problem: Engine noisy (Noise seems to come from piston)	
Condition	Remedy
<ol style="list-style-type: none"> 1. Piston — cylinder worn 2. Combustion chamber carbon buildup 3. Piston pin — piston pin bore worn 4. Piston rings — ring groove(s) worn 	<ol style="list-style-type: none"> 1. Replace — service piston — cylinder 2. Clean chamber 3. Replace — service pin — bore 4. Replace rings — piston
Problem: Engine noisy (Noise seems to come from timing chain)	
Condition	Remedy
<ol style="list-style-type: none"> 1. Chain stretched 2. Sprockets worn 3. Tension adjuster malfunctioning 	<ol style="list-style-type: none"> 1. Replace chain 2. Replace sprockets 3. Repair — replace adjuster
Problem: Engine noisy (Noise seems to come from crankshaft)	
Condition	Remedy
<ol style="list-style-type: none"> 1. Bearing worn — burned 2. Lower rod-end bearing worn — burned 3. Connecting rod side clearance too large 	<ol style="list-style-type: none"> 1. Replace bearing 2. Replace bearing 3. Replace thrust washer(s)
Problem: Engine noisy (Noise seems to come from transmission)	
Condition	Remedy
<ol style="list-style-type: none"> 1. Gears worn — rubbing 2. Splines worn 3. Primary gears worn — rubbing 4. Bearings worn 5. Bushing worn 	<ol style="list-style-type: none"> 1. Replace gears 2. Replace shaft(s) 3. Replace gears 4. Replace bearings 5. Replace bushing
Problem: Engine noisy (Noise seems to come from secondary-transmission/right-side cover)	
Condition	Remedy
<ol style="list-style-type: none"> 1. Gears — shaft(s) worn 2. Bearing(s)/bushing(s) damaged 	<ol style="list-style-type: none"> 1. Replace gears — shafts 2. Replace bearing(s)/bushing(s)

Problem: Engine noisy (Noise seems to come from secondary bevel gear and final driven shaft)	
Condition	Remedy
<ol style="list-style-type: none"> 1. Drive — driven bevel gears damaged — worn 2. Backlash excessive 3. Tooth contact improper 4. Bearing damaged 5. Gears worn — rubbing 6. Splines worn 7. Final driven shaft thrust clearance too large 	<ol style="list-style-type: none"> 1. Replace gears 2. Adjust backlash 3. Adjust contact 4. Replace bearing 5. Replace gears 6. Replace shaft(s) 7. Replace thrust washer(s)
Problem: Centrifugal clutch slipping	
Condition	Remedy
<ol style="list-style-type: none"> 1. Clutch shoes worn 2. Clutch housing excessively worn 3. Drive belt slipping — worn 	<ol style="list-style-type: none"> 1. Replace shoes 2. Replace clutch housing 3. Replace drive belt
Problem: Secondary-transmission will not shift or shift back	
Condition	Remedy
<ol style="list-style-type: none"> 1. Sliding dog broken — worn 2. Gearshift fork broken — worn 3. Hi/Low shift lever out of adjustment 4. Gearshift cam worn 5. Cam stopper spring weak 6. Gearshift fork shaft worn 7. Engine idle too high 8. Shift linkage out of adjustment 	<ol style="list-style-type: none"> 1. Replace dog 2. Replace fork 3. Adjust lever 4. Replace cam 5. Replace spring 6. Replace shaft 7. Adjust engine idle 8. Adjust shift linkage
Problem: Engine idles poorly	
Condition	Remedy
<ol style="list-style-type: none"> 1. Valve clearance out of adjustment 2. Valve seating poor 3. Valve guides defective 4. Rocker arms — arm shaft worn 5. Magneto defective 6. CDI unit defective 7. Spark plug fouled — gap too wide 8. Ignition coil defective 9. Float out of adjustment 10. Jets obstructed 11. Pilot screw setting improper 	<ol style="list-style-type: none"> 1. Adjust clearance 2. Replace — service seats — valves 3. Replace guides 4. Replace arms — shafts 5. Replace magneto 6. Replace CDI unit 7. Adjust gap — replace plug 8. Replace ignition coil 9. Adjust float height 10. Clean jets 11. Adjust pilot screw
Problem: Engine runs poorly at high speed	
Condition	Remedy
<ol style="list-style-type: none"> 1. High RPM “cut out” against RPM limiter 2. Valve springs weak 3. Valve timing out of adjustment 4. Cams — rocker arms worn 5. Spark plug gap too narrow 6. Ignition coil defective 7. Float level too low 8. Air cleaner element obstructed 9. Fuel hose obstructed 	<ol style="list-style-type: none"> 1. Shift into higher gear — decrease speed 2. Replace springs 3. Adjust timing 4. Replace cams — arms 5. Adjust gap 6. Replace ignition coil 7. Adjust float height 8. Clean element 9. Clean — prime hose
Problem: Exhaust smoke dirty or heavy	
Condition	Remedy
<ol style="list-style-type: none"> 1. Oil (in the engine) overfilled — contaminated 2. Piston rings — cylinder worn 3. Valve guides worn 4. Cylinder wall scored — scuffed 5. Valve stems worn 6. Stem seals defective 7. Air cleaner element obstructed 8. Float level too high 	<ol style="list-style-type: none"> 1. Drain excess oil — replace oil 2. Replace — service rings — cylinder 3. Replace guides 4. Replace — service cylinder 5. Replace valves 6. Replace seals 7. Clean element 8. Adjust float level
Problem: Engine lacks power	
Condition	Remedy
<ol style="list-style-type: none"> 1. Valve clearance incorrect 2. Valve springs weak 3. Valve timing out of adjustment 4. Piston ring(s) — cylinder worn 5. Valve seating poor 6. Spark plug fouled 7. Rocker arms — shafts worn 8. Spark plug gap incorrect 9. Carburetor jets obstructed 10. Float level out of adjustment 11. Air cleaner element obstructed 12. Oil (in the engine) overfilled — contaminated 13. Intake manifold leaking air 14. Cam chain worn 	<ol style="list-style-type: none"> 1. Adjust clearance 2. Replace springs 3. Adjust timing 4. Replace — service rings — cylinder 5. Repair seats 6. Clean — replace plug 7. Replace arms — shafts 8. Adjust gap — replace plug 9. Clean jets 10. Adjust float height 11. Clean element 12. Drain excess oil — change oil 13. Tighten — replace manifold 14. Replace cam chain

Problem: Engine overheats

Condition	Remedy
1. Carbon deposit (piston crown) excessive 2. Oil low 3. Octane low — gasoline poor 4. Oil pump defective 5. Oil circuit obstructed 6. Gasoline level (in float chamber) too low 7. Intake manifold leaking air 8. Coolant level low 9. Fan malfunctioning 10. Fan switch malfunctioning 11. Thermostat stuck — closed 12. Radiator hoses/cap damaged — obstructed	1. Clean piston 2. Add oil 3. Drain — replace gasoline 4. Replace pump 5. Clean circuit 6. Adjust float height 7. Tighten — replace manifold 8. Fill — examine system for leaks 9. Check fan fuse — replace fan 10. Replace fan switch 11. Replace thermostat 12. Clear obstruction — replace hoses

Removing Engine/ Transmission

Many service procedures can be performed without removing the engine/transmission from the frame. Closely observe the note introducing each sub-section for this important information.

AT THIS POINT

If the technician's objective is to service/replace left-side cover oil seals, the engine/transmission does not have to be removed from the frame.

Secure the ATV on a support stand to elevate the wheels.

WARNING

Make sure the ATV is solidly supported on the support stand to avoid injury.

1. Remove the seat.
2. Remove the negative cable from the battery; then remove the positive cable.
3. Drain the coolant, engine oil, and transmission gear lubricant; then install the drain plugs and tighten to 21 ft-lb (28.6 N-m).

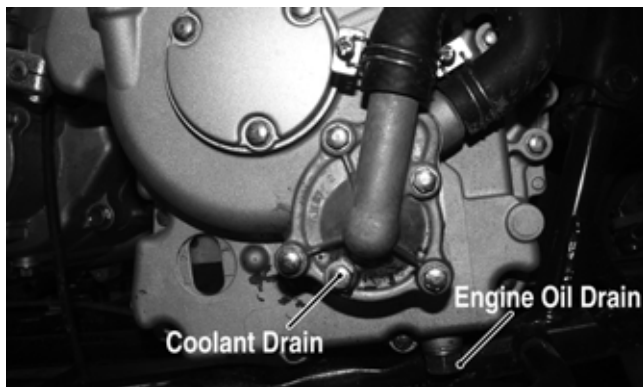

KM314C

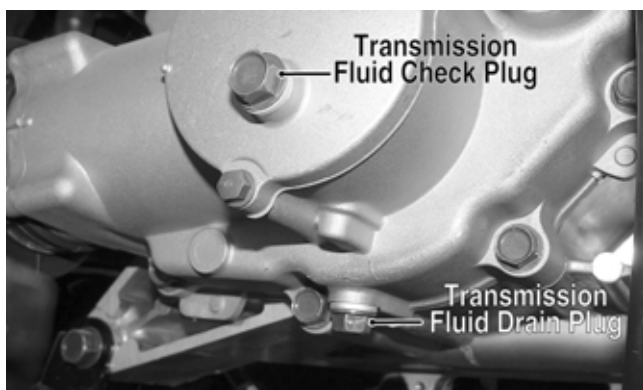

KM954A

4. Remove the front body panel assembly (see Steering/Body/Controls).
5. Remove the air filter housing and remove the gas tank (see Fuel/Lubrication/Cooling).
6. Remove the muffler assembly (see Steering/Body/Controls).

7. Remove the carburetor (see Fuel/Lubrication/Cooling).
8. Remove the ignition coil (see Electrical System).
9. From the right side of the frame, disconnect the stator connector, gear position connector, trigger coil connector, and coolant temperature sensor.

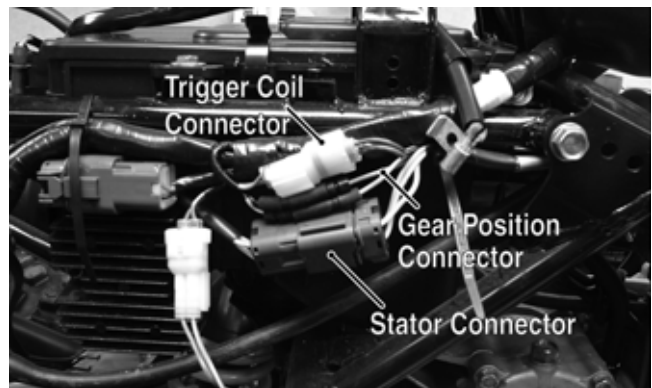

KM347B

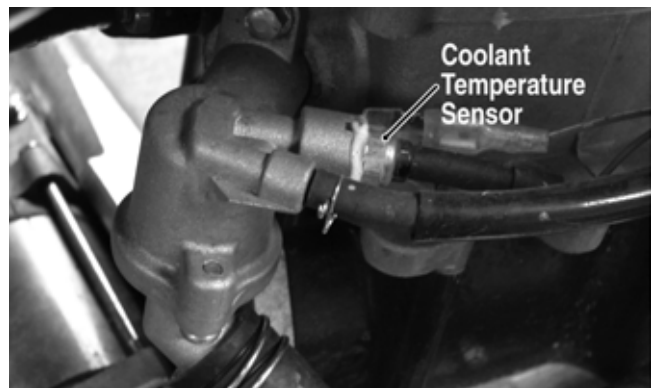

KM324A

10. Remove the starter positive wire; then remove the engine ground wire from the crankcase.

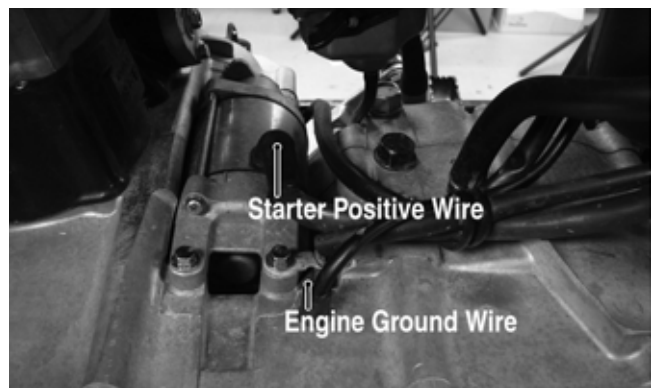

KM319A

11. Remove the front and rear V-belt cooling boots from the V-belt housing; then remove the coolant hoses from the engine.

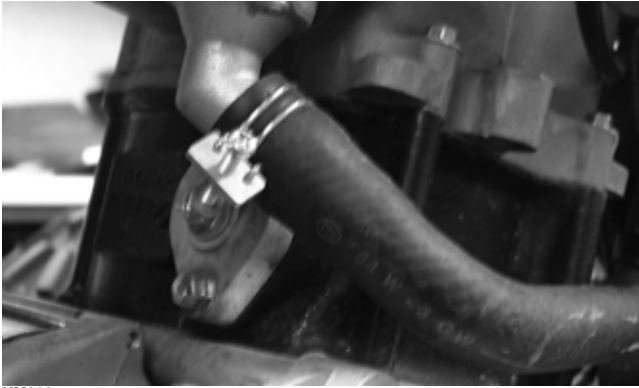

KM323

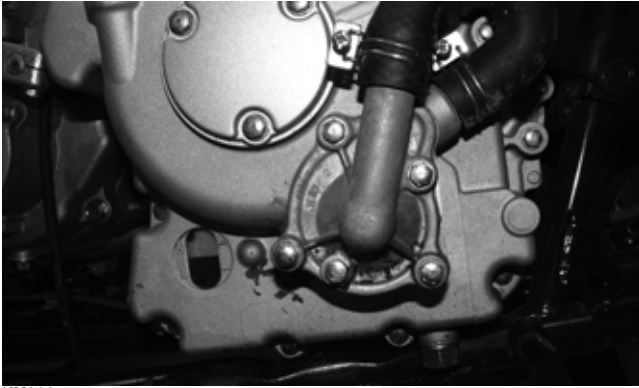

KM314

12. Loosen the output drive boot clamp; then slide the boot off the output housing.

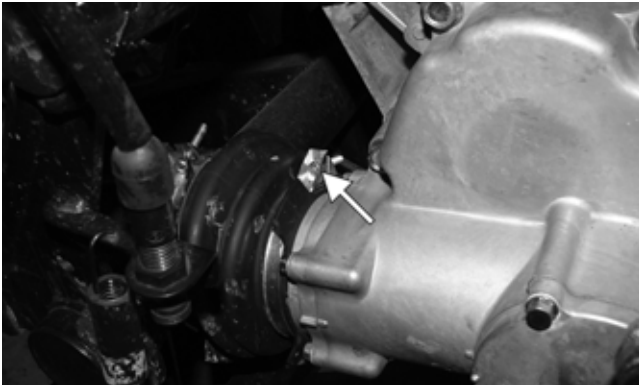

KM315A

13. Disconnect the shift linkage from the transmission shift arm; then swing the shift linkage forward and out of the way.

14. Remove the front engine through-bolt; then remove the two engine mounting brackets from the frame.

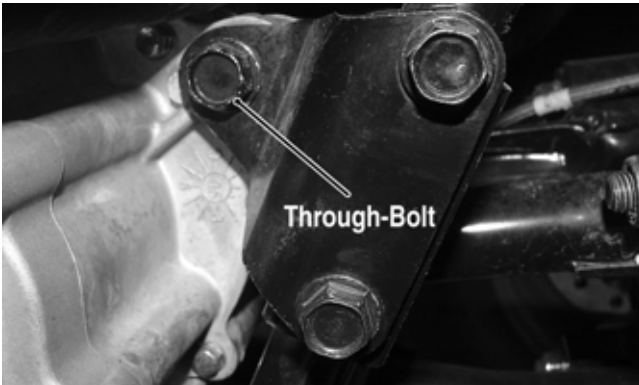

KM414A

15. Attach a suitable lifting sling and engine lift to the front engine mounting boss; then using an engine lift, apply slight upward pressure on the engine/transmission.

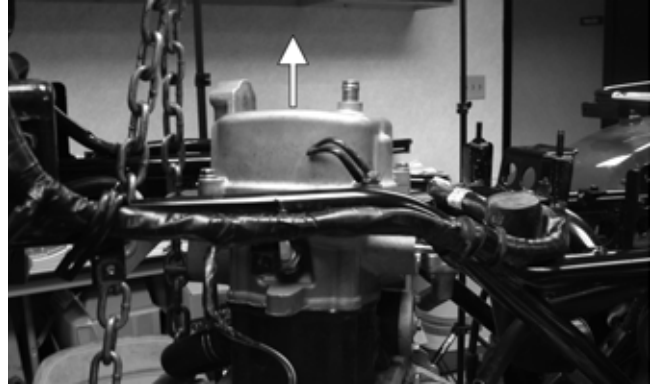

KM332A

16. Remove the upper rear and lower rear engine through-bolts to free the engine/transmission; then raise the front of the engine/transmission sufficiently to allow the engine assembly to be moved forward enough to disengage the driveshaft.



KM333A

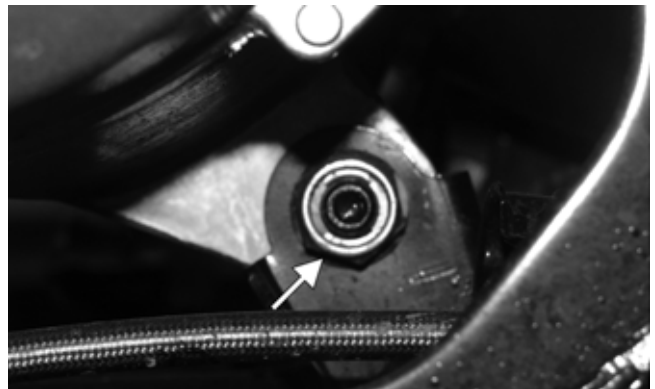

KM325A

17. Swing the rear of the engine/transmission to the left; then slide the engine out of the left side of the frame.

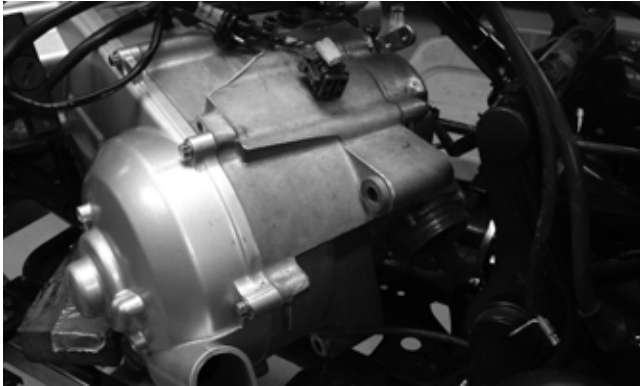

KM329



KM331

Top-Side Components

■NOTE: For efficiency, it is preferable to remove and disassemble only those components which need to be addressed and to service only those components. The technician should use discretion and sound judgment.

🔧 AT THIS POINT

To service any one specific component, only limited disassembly of components may be necessary. Note the AT THIS POINT information in each sub-section.

■NOTE: The engine/transmission does not have to be removed from the frame for this procedure.

Removing Top-Side Components

- A. Valve Cover
- B. Cylinder Head

■NOTE: Remove the spark plug and timing inspection plug; then rotate the crankshaft to top-dead-center of the compression stroke.

1. On the right side, remove the air intake hose from the cylinder head cover. Retain the hose clamp.

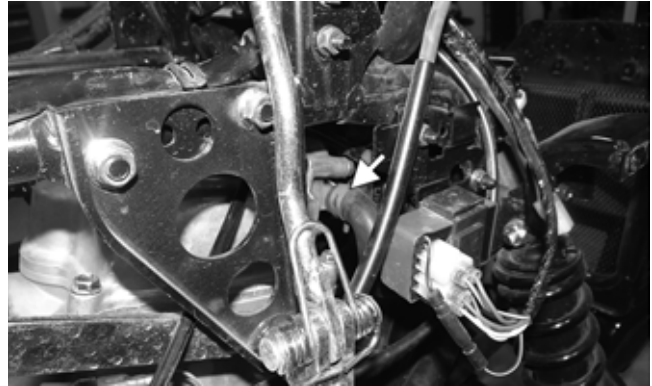

KM941A

2. Remove the vent hose from the top of the cylinder head cover. Retain the hose clamp.

3. Remove the cap screws and nuts securing the air pipe to the cylinder head cover.



KM937A



KM939A

4. Remove the cap screws securing the cylinder head cover. Account for the O-ring.



KM703

■NOTE: Keep the mounting hardware with the cover for assembly purposes.

5. Remove the plug from the cam chain tensioner; then turn the cam chain tensioner screw clockwise to release the chain tension.

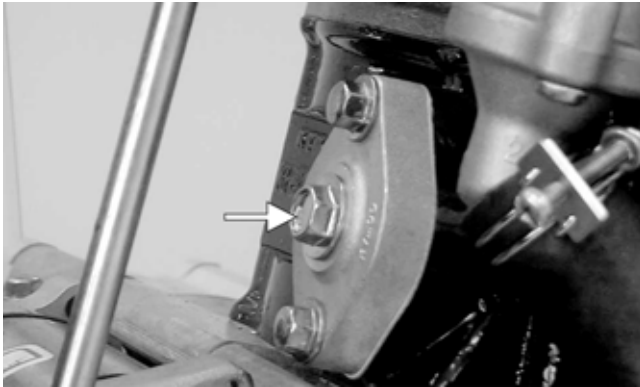

KM704A

6. Using a crisscross pattern, loosen the four nuts securing the camshaft holder to the cylinder head. Use 2-3 steps until the nuts are all free; then remove the camshaft holder. Account for four washers and two alignment pins.

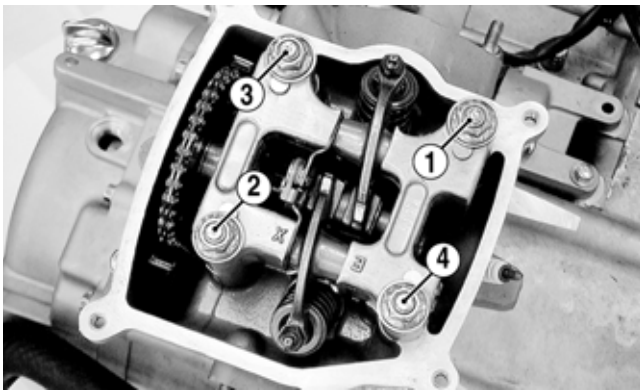

KM706A

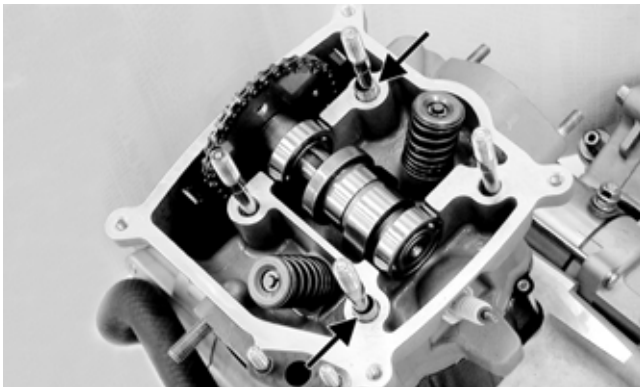

KM707A

7. Remove the camshaft gear from the cam chain; then secure the timing chain so it will not fall into the engine. Remove the camshaft.
8. Remove the two external cap screws securing the cylinder head to the cylinder; then remove the cylinder head. Account for two alignment pins and a cylinder head gasket.

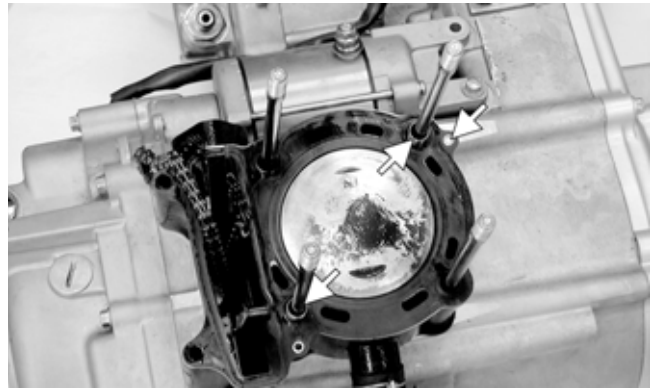

KM718A

9. Remove the cam chain guide; then disconnect the coolant hose and remove the cylinder. Support the piston with rubber bands or other suitable supports. Account for two dowel pins and the cylinder gasket.



KM450

AT THIS POINT

To service valves and cylinder head, see Servicing Top-Side Components sub-section.

AT THIS POINT

To inspect cam chain guide, see Servicing Top-Side Components sub-section.

C. Cylinder

D. Piston

■NOTE: Steps 1-6 in the preceding sub-section must precede this procedure.

AT THIS POINT

To service cylinder, see Servicing Top-Side Components sub-section.

CAUTION

When removing the cylinder, be sure to support the piston to prevent damage to the crankcase and piston.

10. Using a needle nose pliers, remove one piston pin circlip. Take care not to drop it into the crankcase.



KM451

11. Using Piston Pin Puller, remove the piston pin. Account for the opposite-side circlip. Remove the piston.

■NOTE: It is advisable to remove the opposite-side circlip prior to using the puller.

■NOTE: Support the connecting rod with rubber bands to avoid damaging the rod or install a connecting rod holder.

CAUTION

Do not allow the connecting rod to go down inside the crankcase. If the rod is down inside the crankcase and the crankshaft is rotated, severe damage will result.

■NOTE: If the existing rings will not be replaced with new rings, note the location of each ring for proper installation. When replacing with new rings, replace as a complete set only. If the piston rings must be removed, remove them in this sequence.

- A. Starting with the top ring, slide one end of the ring out of the ring-groove.
- B. Remove each ring by working it toward the dome of the piston while rotating it out of the groove.

AT THIS POINT

To service piston, see Servicing Top-Side Components sub-section.

AT THIS POINT

To service center crankcase components only, proceed to Removing Left-Side Components.

Servicing Top-Side Components

VALVE ASSEMBLY

When servicing valve assembly, inspect valve seats, valve stems, valve faces, and valve stem ends for pits, discoloration, or other signs of abnormal wear.

■NOTE: Whenever a valve is out of tolerance, it must be replaced.

Cleaning/Inspecting Camshaft Holder

1. Remove the rocker arm shafts, rocker arms, and stop plate from the camshaft holder.

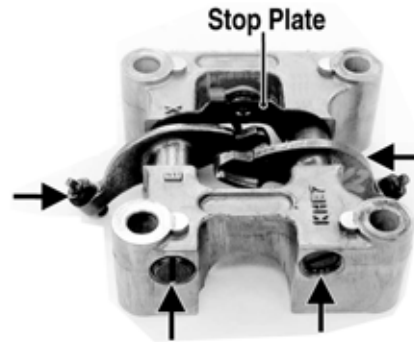

KM708A

2. Inspect the camshaft holder for cracks, distortion, or galling.
3. Inspect the rocker arm shafts for blue discoloration or scoring.
4. Inspect the rocker arms for excessive wear, loose adjusters, or scored camshaft followers.

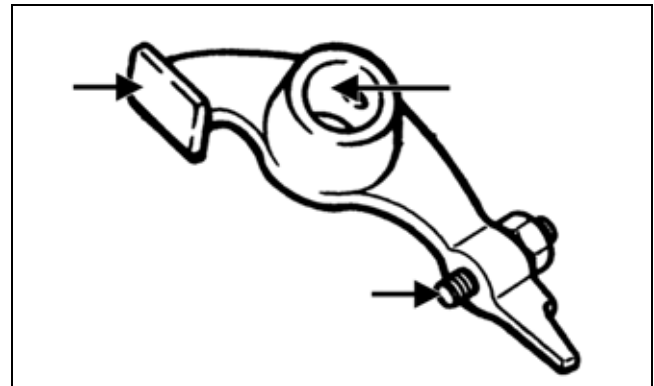

KM710A

Removing Valves

■NOTE: Keep all valves and valve components as a set. Note the original location of each valve set for use during installation. Return each valve set to its original location during installation.

1. Using a valve spring compressor, compress the valve springs and remove the valve cotters. Account for an upper spring retainer.

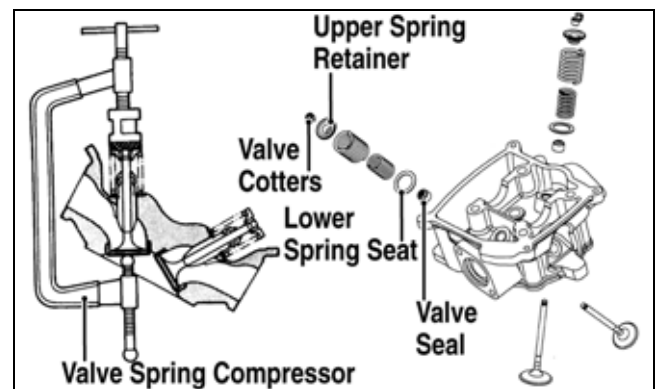

KM717A

2. Remove the valve seal, valve springs, and the lower remaining spring seat. Discard the valve seal.

■NOTE: The valve seals must be replaced.

3. Invert the cylinder head and remove the valves.

Measuring Valve Stem/Valve Guide Clearance

1. Using a micrometer, measure the valve stem outside diameter; then using a suitable snap gauge and micrometer, measure the valve guide inside diameter.
2. Acceptable clearance must be within specifications.

Inspecting Valve Face

Inspect the valve face for pitting, grooving, or discoloration. Replace any valve that is damaged.

CYLINDER HEAD ASSEMBLY

■NOTE: If the cylinder head cannot be trued, it must be replaced.

Cleaning/Inspecting Cylinder Head

1. Using a non-metallic carbon removal tool, remove any carbon build-up from the combustion chamber making sure not to nick, scrape, or damage the combustion chamber or the sealing surface.
2. Inspect the spark plug hole for any damaged threads. Repair damaged threads using a “heli-coil” insert.
3. Place the cylinder head on the surface plate covered with #400 grit wet-or-dry sandpaper. Using light pressure, move the cylinder head in a figure-eight motion. Inspect the sealing surface for any indication of high spots. A high spot can be noted by a bright metallic finish. Correct any high spots before assembly by continuing to move the cylinder head in a figure-eight motion until a uniform bright metallic finish is attained.

CAUTION

Water or parts-cleaning solvent must be used in conjunction with the wet-or-dry sandpaper or damage to the sealing surface may result.

Measuring Cylinder Head Distortion

1. Remove any carbon buildup in the combustion chamber.
2. Lay a straightedge across the cylinder head; then using a feeler gauge, check the distortion factor between the head and the straightedge.
3. Maximum distortion must not exceed specifications.

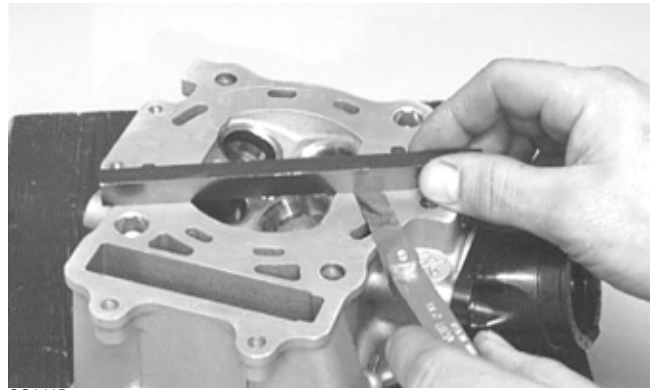

CC141D

Measuring Camshaft Lobe Height

1. Using a calipers, measure each cam lobe height.

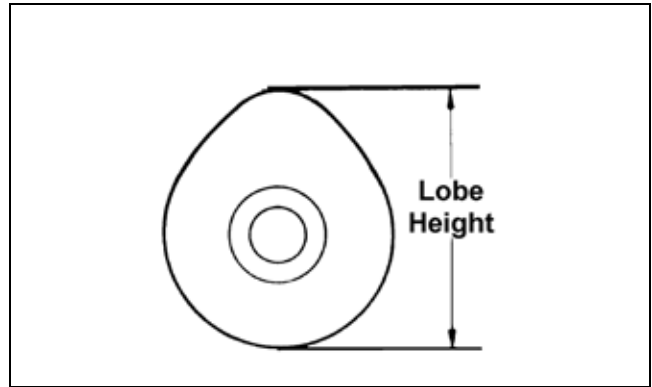

ATV1013A

2. The lobe heights must not be less than minimum specifications.

Inspecting Camshaft Bearing Journal

1. Inspect the bearing journal for scoring, seizure marks, or pitting.
2. If excessive scoring, seizure marks, or pitting is found, the cylinder head assembly must be replaced.

Measuring Rocker Arm/Shaft Clearance

1. Using a dial calipers, measure the inside diameter of the rocker arm; then measure the outside diameter of the rocker arm shaft.
2. Acceptable clearance must not exceed specifications.

Installing Valves

1. Apply grease to the inside surface of the valve seals; then place a lower spring seat and valve guide seal over each valve guide.
2. Insert each valve into its original valve location.
3. Install the valve springs with the closest coils toward the cylinder head.

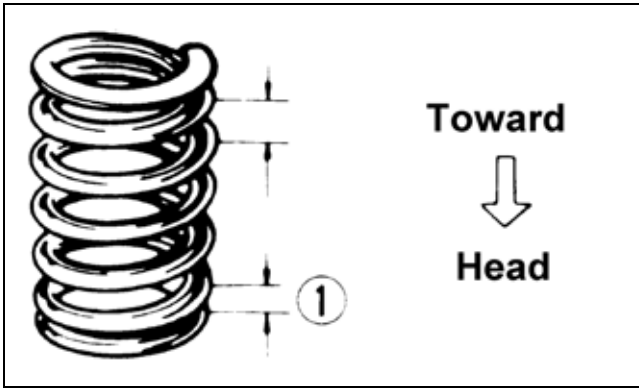

ATV-1011A

- Place a spring retainer over the valve springs; then using the valve spring compressor, compress the valve springs and install the valve cotters.

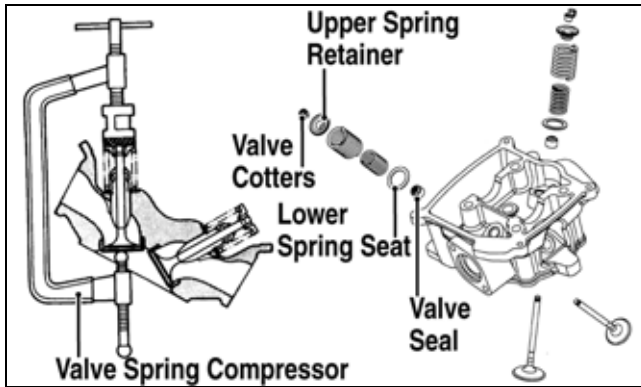

KM717A

PISTON ASSEMBLY

■NOTE: Whenever a piston, rings, or pin are out of tolerance, they must be replaced.

Inspecting Piston

- Inspect the piston for cracks in the piston pin, dome, and skirt areas.
- Inspect the piston for seizure marks or scuffing. Repair with #400 grit wet-or-dry sandpaper and water or honing oil.

■NOTE: If scuffing or seizure marks are too deep to correct with the sandpaper, replace the piston.

- Inspect the perimeter of each piston for signs of excessive "blowby." Excessive "blowby" indicates worn piston rings or an out-of-round cylinder.

Removing Piston Rings

- Starting with the top ring, slide one end of the ring out of the ring-groove.



CC400D

- Remove each ring by working it toward the dome of the piston while rotating it out of the groove.

■NOTE: If the existing rings will not be replaced with new ones, note the location of each ring for proper installation. When installing new rings, install as a complete set only.

Measuring Piston-Ring End Gap (Installed)

- Place each piston ring in the wear portion of the cylinder. Use the piston to position each ring squarely in the cylinder.
- Using a feeler gauge, measure each piston-ring end gap. Acceptable ring end gap must not exceed specifications.

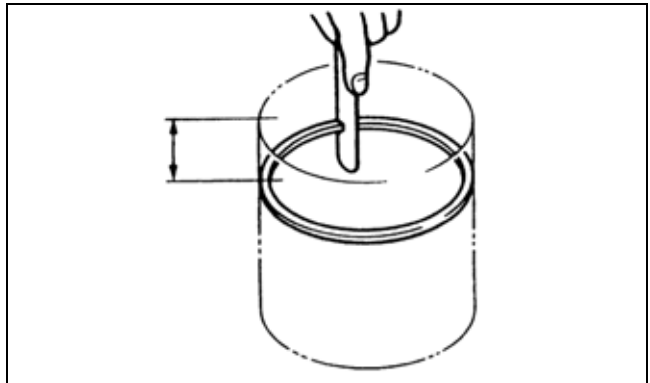

KM452

Measuring Piston Pin (Outside Diameter) and Piston-Pin Bore

- Measure the piston pin outside diameter at each end and in the center. If measurement is not within specifications, the piston pin must be replaced.

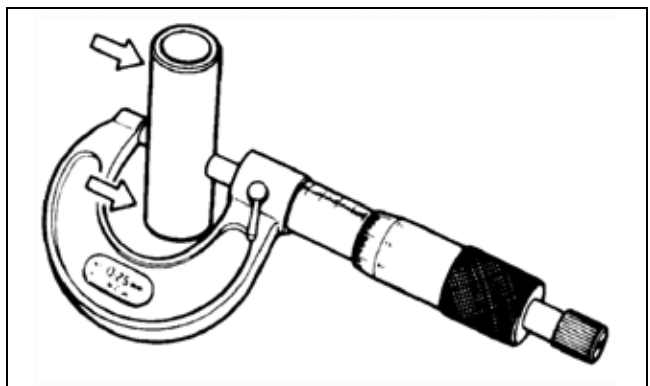

ATV-1070

2. Insert an inside dial indicator into the piston-pin bore. The diameter must not exceed specifications. Take two measurements to ensure accuracy.

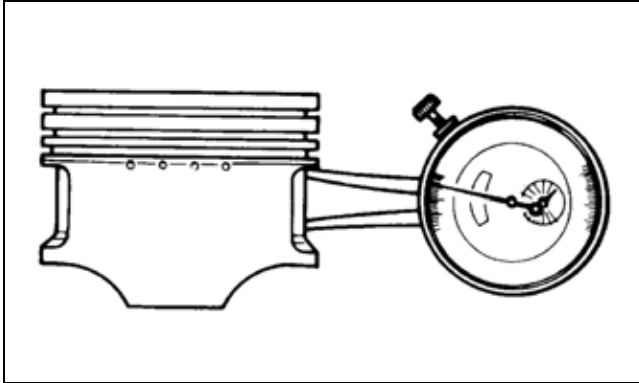

ATV-1069

Measuring Piston Skirt/ Cylinder Clearance

1. Using a slide gauge and a dial indicator or a snap gauge, measure the cylinder bore diameter in three locations from top to bottom and again from top to bottom at 90° from the first measurements for a total of six measurements. The trueness (out-of-roundness) is the difference between the highest and lowest reading. Maximum trueness (out-of-roundness) must not exceed specifications.

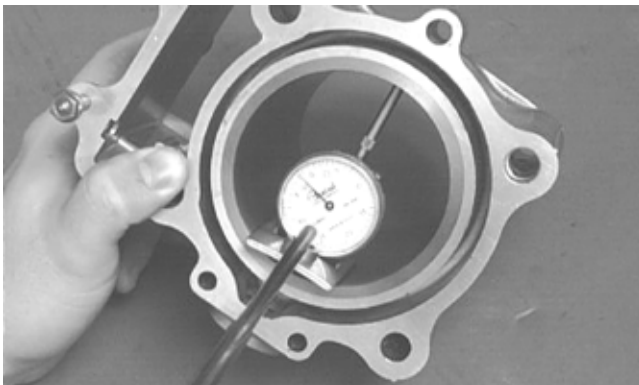

CC127D

2. Measure the corresponding piston diameter at a point 0.7 in (18 mm) above the piston skirt at a right angle to the piston-pin bore. Subtract this measurement from the measurement in step 1. The difference (clearance) must be within specifications.

Installing Piston Rings

1. Install expander (4) in the bottom groove of the piston; then install the thin oil rings (3) over the expander making sure the expander ends do not overlap. Stagger the end gaps of the upper and lower thin oil rings according to the illustration.

■NOTE: Note the direction of the exhaust side of the piston (5) for correct ring end gap orientation.

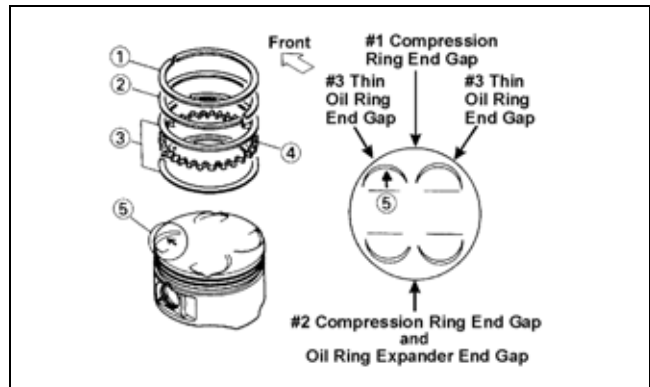

ATV-1085B

2. Install the compression rings (1 and 2) so the letter on the top surface of each ring faces the dome of the piston. Rotate the rings until the ring end gaps are on directly opposite sides of the piston according to the illustration.

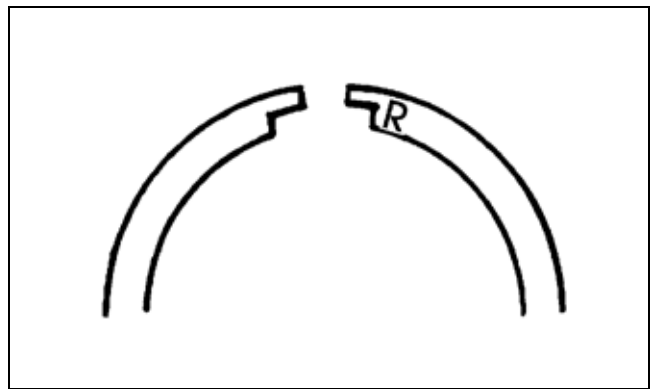

726-306A

CAUTION

Incorrect installation of the piston rings will result in engine damage.

CYLINDER ASSEMBLY

■NOTE: If the cylinder cannot be trued, it must be replaced.

Cleaning/Inspecting Cylinder

1. Wash the cylinder in parts-cleaning solvent.
2. Inspect the cylinder for pitting, scoring, scuffing, warpage, and corrosion. If marks are found, repair the surface using a surface plate.
3. Place the cylinder on the surface plate covered with #400 grit wet-or-dry sandpaper. Using light pressure, move the cylinder in a figure-eight motion. Inspect the sealing surface for any indication of high spots. A high spot can be noted by a bright metallic finish. Correct any high spots before assembly by continuing to move the cylinder in a figure-eight motion until a uniform bright metallic finish is attained.

CAUTION

Water or parts-cleaning solvent must be used in conjunction with the wet-or-dry sandpaper or damage to the sealing surface may result.

Inspecting Cam Chain Guide

1. Inspect cam chain guide for cuts, tears, breaks, or chips.
2. If the chain guide is damaged, it must be replaced.

Honing Cylinder

1. Wash the cylinder in parts-cleaning solvent.
2. Inspect the cylinder for pitting, scoring, scuffing, and corrosion. If marks are found, repair the surface using a #320 grit ball hone.

■NOTE: To produce the proper 60° crosshatch pattern, use a low RPM drill (600 RPM) at the rate of 30 strokes per minute. If honing oil is not available, use a lightweight petroleum-based oil. Thoroughly clean cylinder after honing using soap and hot water. Dry with compressed air; then immediately apply oil to the cylinder bore. If the bore is severely damaged or gouged, replace the cylinder.

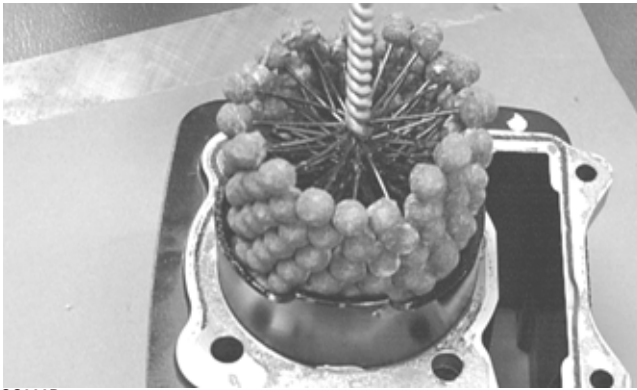

CC390D

3. If any measurement exceeds the limit, replace the cylinder.

Installing Top-Side Components

A. Piston

B. Cylinder

1. Install the piston on the connecting rod making sure there is a circlip on each side and the open end of the circlip is directed upwards or downwards.

■NOTE: The piston should be installed so the IN mark is toward the intake (rear) side of the cylinder.

2. Place the two alignment pins into position. Place the cylinder gasket into position; then place a piston holder (or suitable substitute) beneath the piston skirt and square the piston in respect to the crankcase.

3. Lubricate the inside wall of the cylinder; then using a ring compressor or the fingers, compress the rings and slide the cylinder over the piston. Route the cam chain up through the cylinder cam chain housing; then remove the piston holder and seat the cylinder firmly on the crankcase.

CAUTION

The cylinder should slide on easily. Do not force the cylinder or damage to the piston, rings, cylinder, or crankshaft assembly may occur.

4. Turn the cam chain tensioner screw clockwise to retract the tensioner spring.

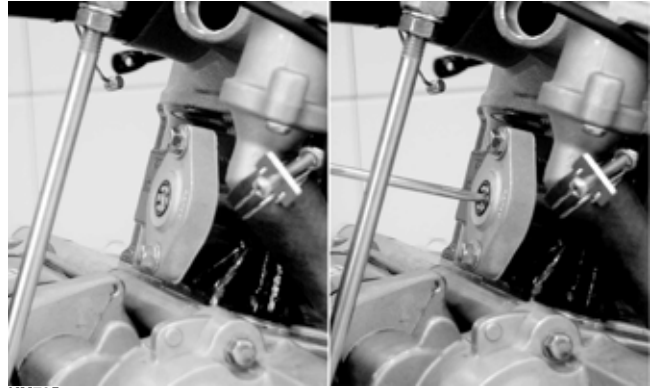

KM705

C. Cylinder Head

D. Valve Cover

■NOTE: Steps 1-4 in the preceding sub-section must precede this procedure.

5. While keeping tension on the cam chain, place the front cam chain guide into the cylinder.

CAUTION

Care should be taken that the bottom of the chain guide is secured in the crankcase boss.

6. Place the head gasket into position on the cylinder. Place the alignment pins into position; then place the head assembly into position on the cylinder making sure the cam chain is routed through the chain cavity.

CAUTION

Keep tension on the cam chain to avoid damaging the crankcase boss.

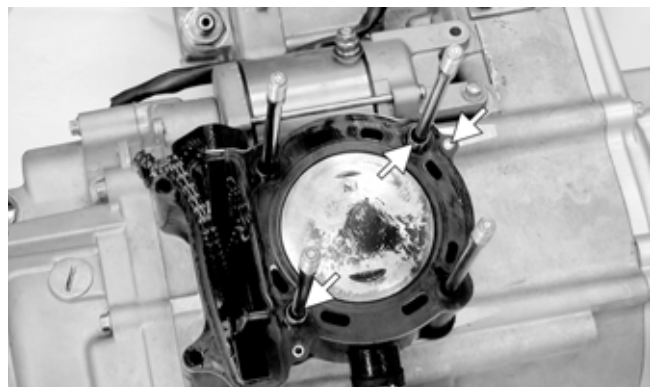

KM718A

- Turn the crankshaft as required to align the “T” mark on the rotor/flywheel with the index mark on the right-side crankcase cover.



KM779A

- With the index hole in the camshaft gear directed away from the cylinder head and the two punch marks aligned with the cylinder head surface, install the timing gear into the cam chain and seat the camshaft into the camshaft journals.

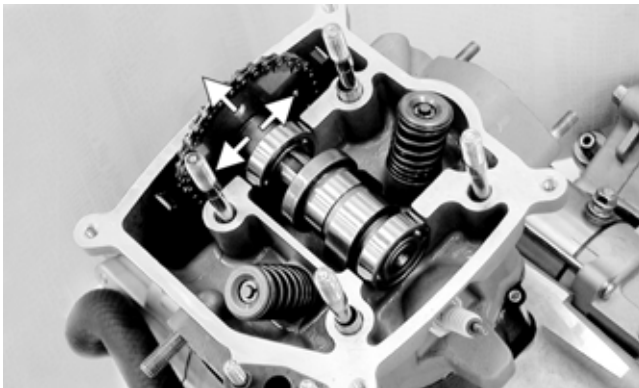

KM715A

- Install the two alignment pins; then install the camshaft holder and secure with the four cylinder head nuts and washer. Using a crisscross pattern, tighten to 18 ft-lb (24.5 N-m).

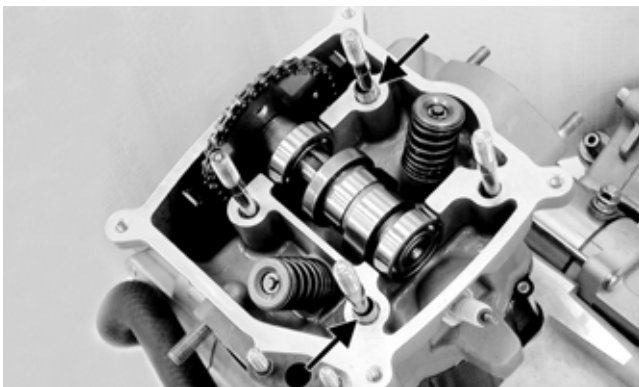

KM707A

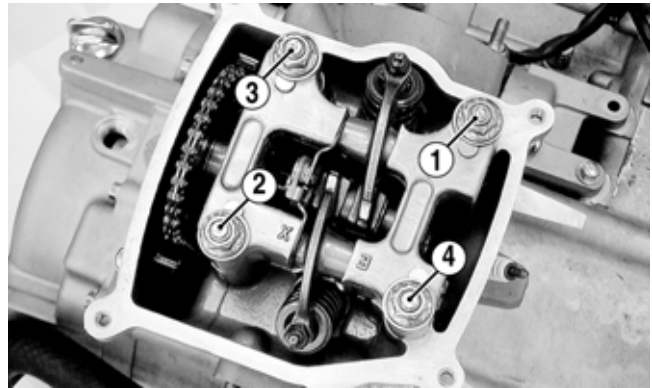

KM706A

- Install the cam chain tensioner assembly and tighten the mounting cap screws to 9 ft-lb (12.2 N-m); then turn the tensioner screw counterclockwise to tension the cam chain.

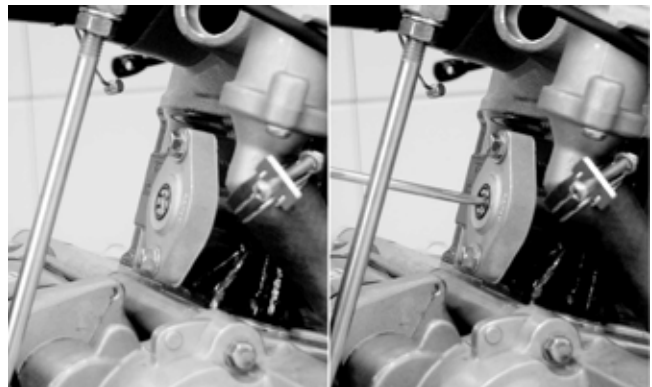

KM705

- Install the cam chain tensioner cover bolt and tighten to 24 in-lb (32.6 N-m).
- Check that the cam gear alignment marks are correctly oriented; then install and tighten the external cylinder head to cylinder cap screws to 7 ft-lb (9.5 N-m).
- Install the cylinder head cover with a new O-ring and tighten securely.



KM703

- Install the air pipe and vent hose using the existing cap screws and clamp.



KM937A



KM938A

15. Install the air hose into the cylinder head.

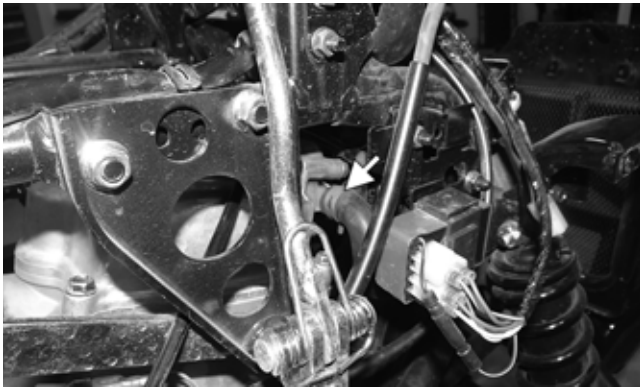

KM941A

Left-Side Components

■NOTE: For efficiency, it is preferable to remove and disassemble only those components which need to be addressed and to service only those components. The technician should use discretion and sound judgment.

AT THIS POINT

To service any one specific component, only limited disassembly of components may be necessary. Note the AT THIS POINT information in each sub-section.

■NOTE: The engine/transmission does not have to be removed from the frame for this procedure.

Removing Left-Side Components

A. Recoil Starter

1. Remove the five recoil starter cover cap screws. Remove the recoil starter assembly noting the location of the dowel pins. Note the condition of the recoil cover gasket. Replace if damaged.

AT THIS POINT

To service the recoil starter, see Servicing Left-Side Components sub-section.

B. V-Belt Cover

C. Drive Pulley

D. Driven Pulley/Centrifugal Clutch Assembly

■NOTE: Step 1 in the preceding sub-section must precede this procedure.

2. Remove the ten cap screws securing the V-belt cover; then remove the cover noting the location of the two dowel pins. Note the condition of the V-belt cover gasket. Replace if damaged.

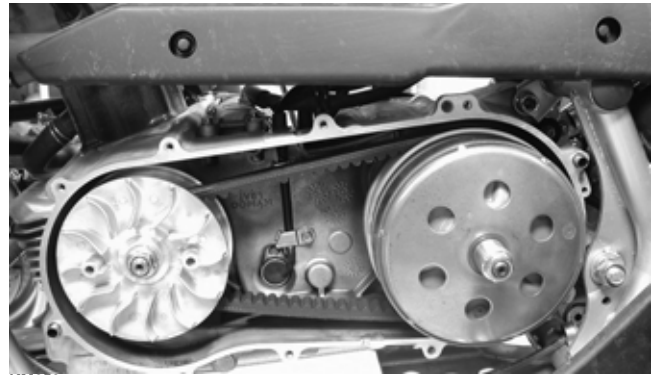

KM253

3. Using a suitable holder to prevent the drive pulley from turning, remove the drive face nut and starter ratchet; then remove the drive pulley face.



KM365

4. Hold the centrifugal clutch with a suitable holder; then remove the clutch retaining nut and clutch collar.

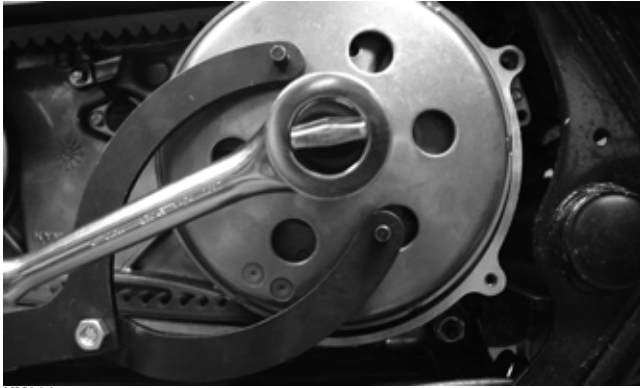

KM364

- Remove the outer clutch housing; then remove the centrifugal clutch, driven pulley, and V-belt.



KM369

- Remove the drive pulley collar and the movable drive face taking care not to lose the rollers.

Servicing Left-Side Components

RECOIL STARTER

WARNING

Always wear safety glasses when servicing the recoil starter.

Removing/Disassembling

- Remove the cap screws securing the recoil starter assembly to the V-belt cover; then remove the starter. Account for two alignment pins.

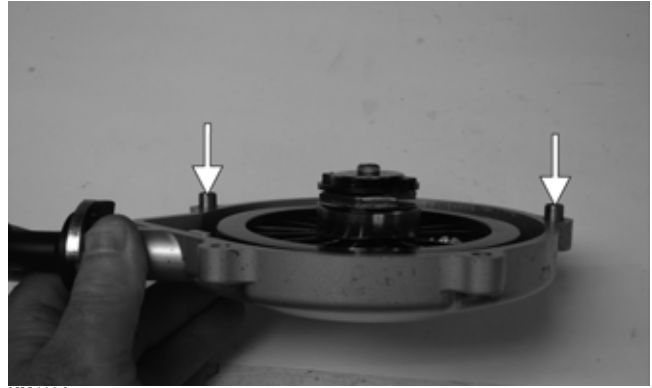

KM413A

WARNING

During the disassembling procedure, continuous backward pressure must be exerted on the reel so it does not accidentally unwind and cause injury.

- Rotate the reel clockwise until the notch of the reel is near the rope guide in the case. Guide the rope into the notch and slowly allow the reel to unwind until all spiral spring tension is released.

CAUTION

During the disassembling procedure, make sure all spring tension is released before continuing.

- Remove the cap screw. Account for the ratchet guide, spacer, and spring.

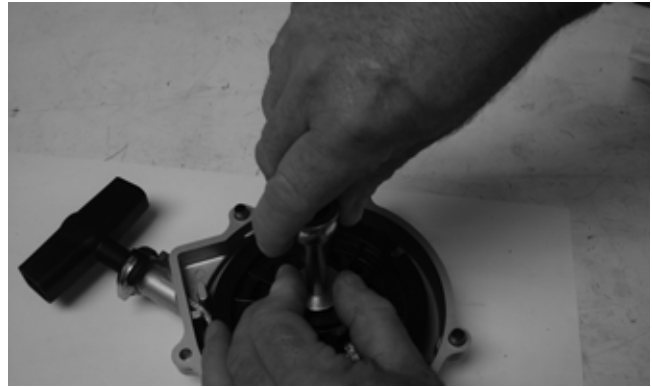

KM411

- Carefully lift the reel free of the case making sure the spiral spring does not accidentally disengage from the case.

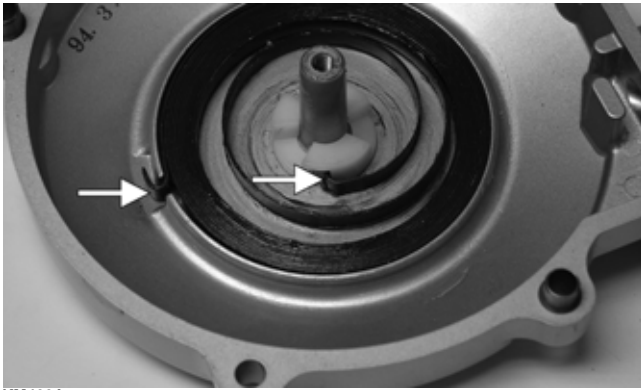

KM402A

⚠ WARNING

Care must be taken when lifting the reel free of the case. Wear safety glasses to avoid injury.

- Remove the protective cover from the starter handle and pull the rope out of the handle; then untie the knot in the rope and remove the handle. Account for a flat washer.



KM408

■NOTE: Do not remove the spiral spring unless replacement is necessary. It should be visually inspected in place to save time. If replacement is necessary, follow steps 6-7.

- Remove the spiral spring from the case by lifting the spring end up and out. Hold the remainder of the spring with thumbs and alternately release each thumb to allow the spring to gradually release from the case.
- Unwind the rope from the reel and remove the rope.

Cleaning and Inspecting

- Clean all components.
- Inspect the springs and ratchet for wear or damage.
- Inspect the reel and case for cracks or damage.
- Inspect the shaft for wear, cracks, or damage.
- Inspect the rope for breaks or fraying.
- Inspect the spiral spring for cracks, crystallization, or abnormal bends.
- Inspect the handle for damage, cracks, or deterioration.

Assembling/Installing

- If removed, insert the spiral spring into the case with the outer end of the spring around the mounting lug in the case; then wind it in a counterclockwise direction until the complete spring is installed.

■NOTE: The spiral spring must seat evenly in the recoil case.



KM402

- Insert the rope through the hole in the reel and tie a knot in the end; then wrap the rope clockwise around the reel leaving approximately 50 cm (20 in) of rope free of the reel.
- Apply low-temperature grease to the spring and hub.
- Thread the end of the rope through the guide hole of the case; then thread the rope through the handle and washer and secure it with a double knot. Install the protective cover into the handle.



KM400



KM405

- Align the inner hook of the spiral spring with the notch in the reel spacer.

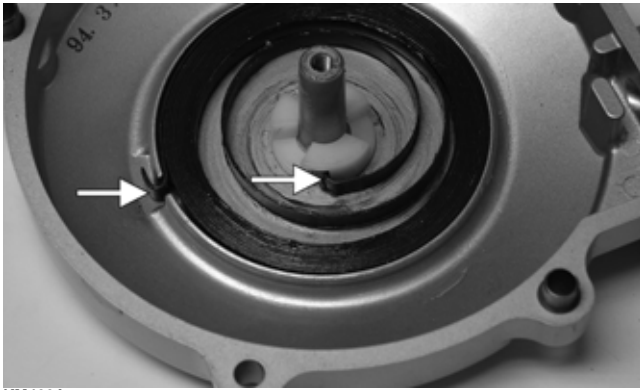

KM402A

6. Install the ratchets making sure the ends are properly oriented on the reel.



KM397A

7. Install the spacer, spring, and the ratchet guide making sure the ratchet pins engage the guide.



KM401

8. Hold the ratchet guide down in place on the ratchet pins and secure with the cap screw coated with blue Loctite #243. Tighten securely.



KM410

9. With the 50 cm (20 in) of rope exposed, hook the rope in the notch of the reel.
10. Rotate the reel four turns clockwise; then release the rope from the notch and allow the rope to retract.
11. Pull the rope out two or three times to check for correct tension and ratchet extender.

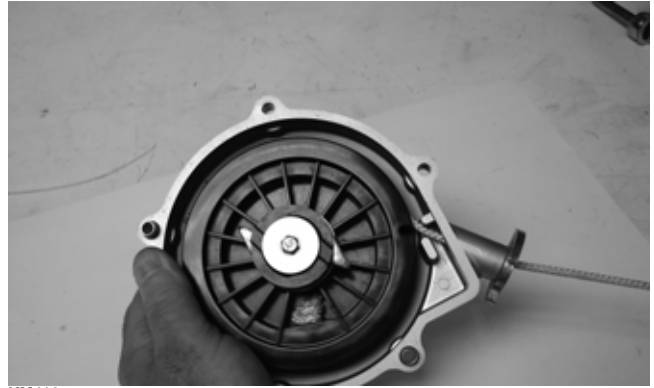

KM412

■NOTE: Increasing the rotations in step 10 will increase spring tension.

12. Place the recoil starter assembly into position on the left-side cover; then tighten the cap screws securely.

V-BELT COVER

1. Inspect the bearing for excessive wear, rough or binding when turning, seal condition, and secure mounting in the V-belt cover.

■NOTE: If the bearing is worn excessively, turns roughly, or bearing seals are loose, the bearings must be replaced.



KM254

2. Inspect the V-belt cover for cracks, distortion, and loose alignment pins.

■NOTE: If the V-belt cover is cracked or distorted or if the bearing is loose in the cover, the cover must be replaced.

DRIVE PULLEY

1. Remove the ramp plate from the movable drive face; then inspect the ramp plate guides and weight roller for damage or excessive wear.

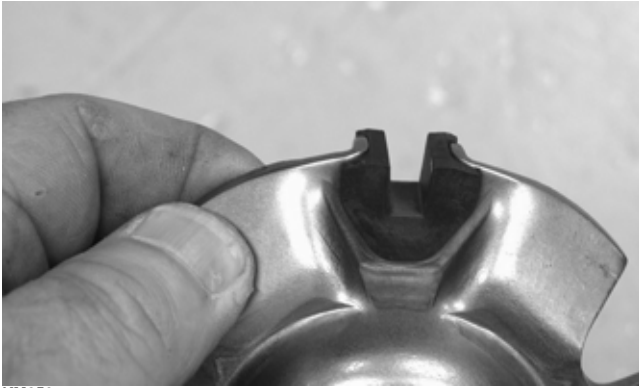

KM256

2. Inspect the face surfaces of the fixed and movable drive faces for grooving, nicks, or discoloration.

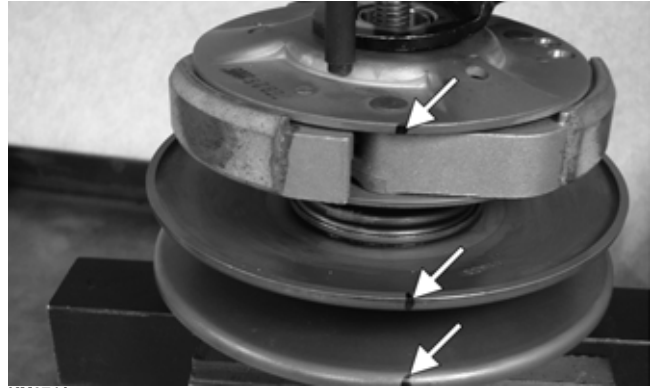

KM374A

2. Secure the centrifugal clutch with the spring compressor; then remove the drive plate nut.



KM394A

3. Inspect the drive pulley collar for wear or damage. Measure the outside diameter of the drive pulley collar sliding surface. The minimum service limit is 1.06 in (26.94 mm).

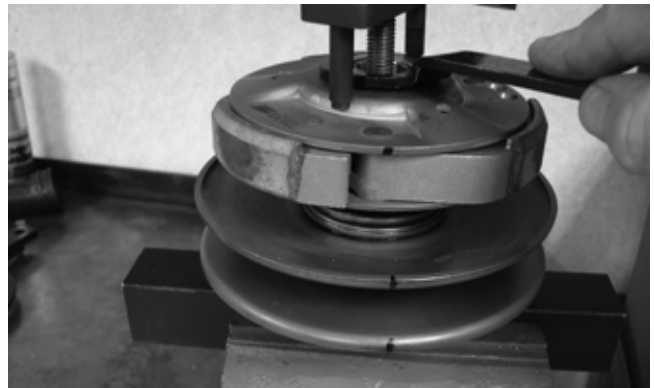

KM373

3. Release the spring pressure and remove the centrifugal clutch assembly from the driven pulley.



KM389



KM375

4. Remove the spring and spring seat; then remove the hub collar.

DRIVEN PULLEY/CENTRIFUGAL CLUTCH ASSEMBLY

Disassembling

⚠ WARNING

This procedure involves relaxing a compressed spring assembly. **DO NOT** attempt disassembling without the proper tools.

1. Place the driven pulley on a suitable spring compressor; then mark the pulley faces and centrifugal clutch for alignment during assembling.



KM385

5. Remove four pins and bushings from the fixed face hub; then remove the movable face.



KM384

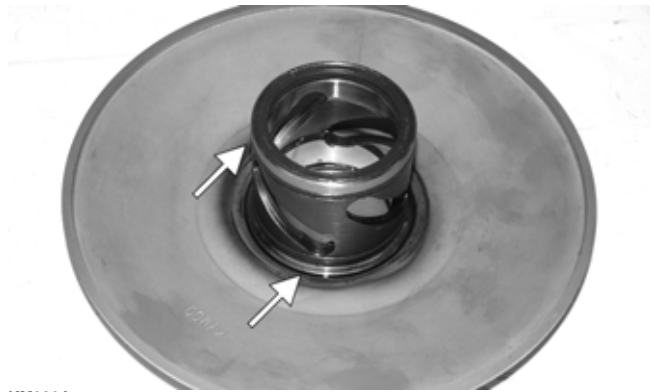

KM380A

3. Inspect two grease seals in the movable face for nicks, cuts, or damage.



KM380

Inspecting

1. Inspect the pulley faces for wear, galling, or grooving.



KM394A

2. Inspect the O-rings on the movable face for nicks, tears, or swelling.



KM380B

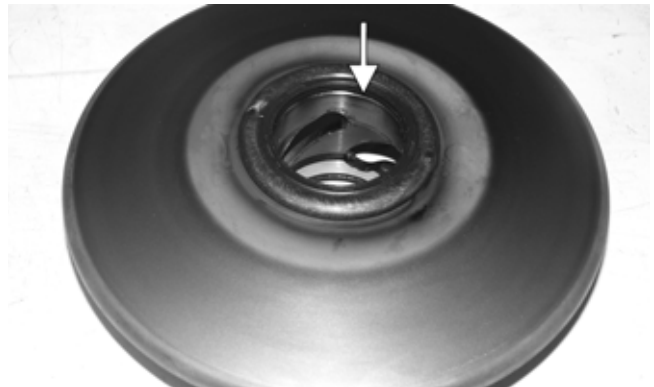

KM382A

4. Inspect the pins and bushings for wear, flat spots, looseness, or cracking.



KM379

5. Measure the driven face spring free length. If the free length is less than 5.2 in (131 mm), the spring must be replaced.

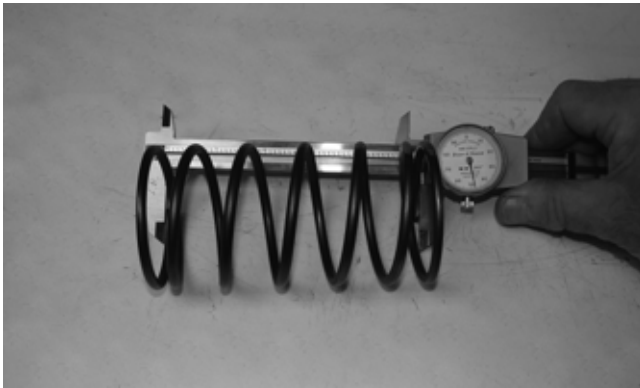

KM376

6. Measure the driven fixed face hub using a calipers. The minimum service limit is 1.57 in (39.93 mm).

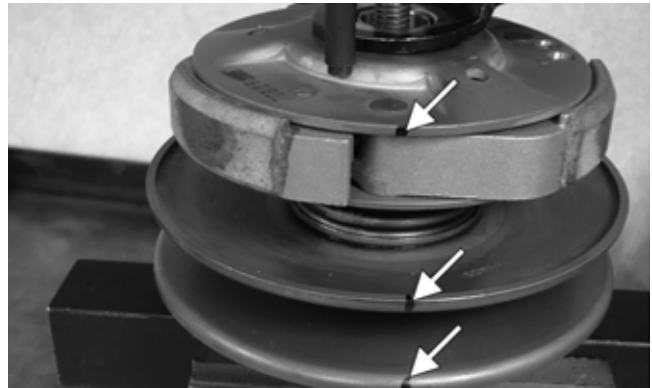

KM374A

3. Install the pins and spacers into the fixed face hub; then pack the cam slots in the movable face with multi-purpose grease.



KM378

7. Measure the thickness of the centrifugal clutch shoe lining. The minimum service limit for the lining is 0.02 in (0.5 mm).

■NOTE: If any shoe lining is below the service limit, the complete set must be replaced.

Assembling

1. Place the fixed face of the driven pulley on the pulley compressor base.

■NOTE: Make sure the spacer is on the base or damage to the fixed face will occur when the spring is compressed.



KM384

4. Install the spring seat over the hub and movable face hub.



KM385

5. Place the spring holder on the spring; then install the spring on the pulley assembly.

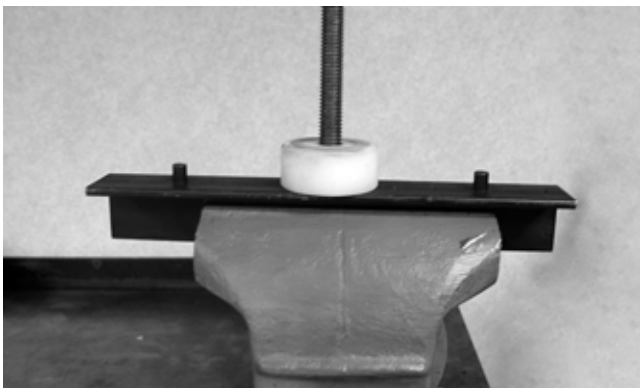

KX571

2. Apply multi-purpose grease to the O-rings and grease seals on the movable face; then install on the fixed face making sure the alignment marks are properly aligned.



KM386

- Place the centrifugal clutch assembly, drive plate nut, and clutch compressor adapter in position; then using the clutch compressor wing nut, compress the clutch spring and install the nut (lightly coated with red Loctite #271).

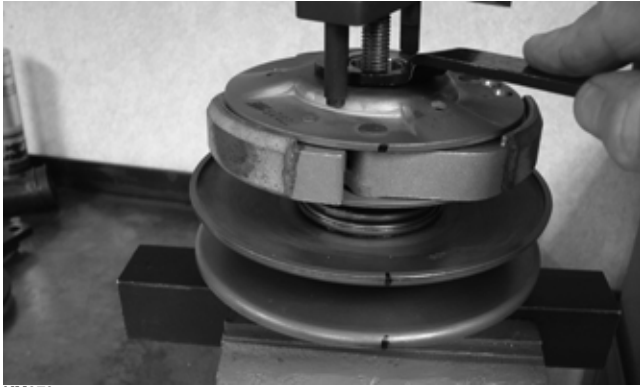

KM373

- Using a suitable holding fixture, tighten the drive plate nut (coated with red Loctite #271) to 43 ft-lb (58.5 N-m).

Installing Left-Side Components

- A. Drive Pulley**
- B. Driven Pulley/Centrifugal Clutch Assembly**
- C. V-Belt Cover**

- Install the movable drive face and drive pulley collar on the crankshaft.
- Open the faces of the driven pulley; then insert a suitable wedge between the faces to hold them apart.
- Place the V-belt around the pulley and push the belt down between the pulley faces; then install the driven pulley/centrifugal clutch assembly onto the driveshaft. Loop the V-belt over the drive pulley collar.



KM262



KM369

- Place the fixed drive face into position on the crankshaft and engage the splines making sure the splines extend beyond the pulley face hub.

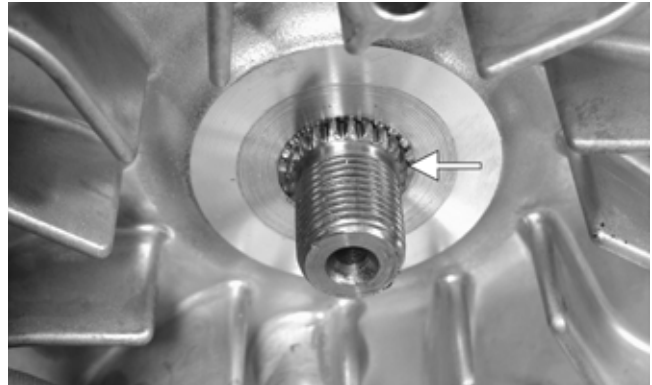

KM263A

- Install the starter ratchet on the crankshaft making sure to engage the splines; then secure with the flange nut and tighten to 68 ft-lb (92.5 N-m).

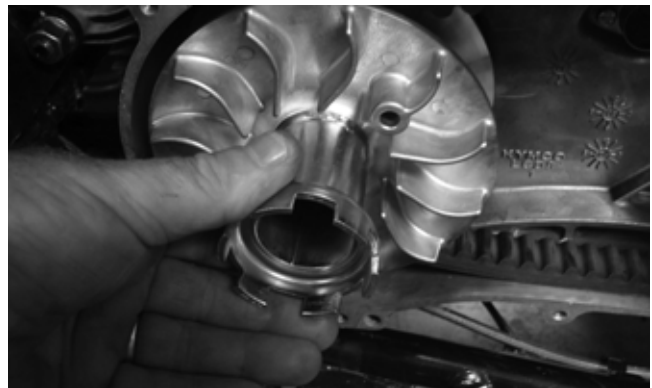

KM366



KM365

6. Install the centrifugal clutch housing and clutch collar; then secure with the flange nut and tighten to 40 ft-lb (54.4 N-m).



KM253

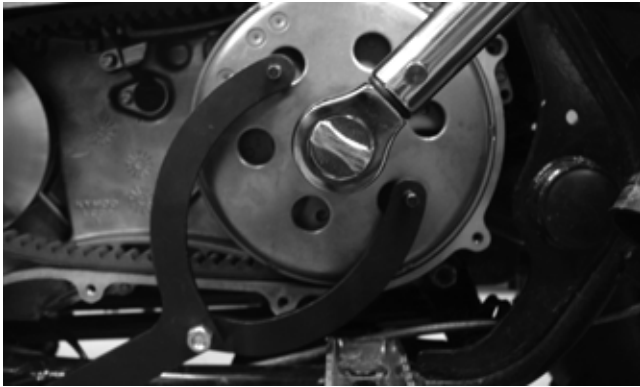

KM368

7. Install the alignment pins and a new gasket on the crankcase; then install the V-belt cover and secure with the cap screws. Tighten securely.
8. Install the recoil starter and secure with the cap screws. Tighten securely.

Right-Side Components

👉 AT THIS POINT

To service center crankcase components only, proceed to Removing Right-Side Components.

■NOTE: For efficiency, it is preferable to remove and disassemble only those components which need to be addressed and to service only those components. The technician should use discretion and sound judgment.

👉 AT THIS POINT

To service any one specific component, only limited disassembly of components may be necessary. Note the AT THIS POINT information in each sub-section.

■NOTE: The engine/transmission does not have to be removed from the frame for this procedure.

Removing Right-Side Components

A. Transmission

1. Drain the transmission lubricant into a suitable container; then install the drain plug (A) and tighten to 21 ft-lb (28.6 N-m).

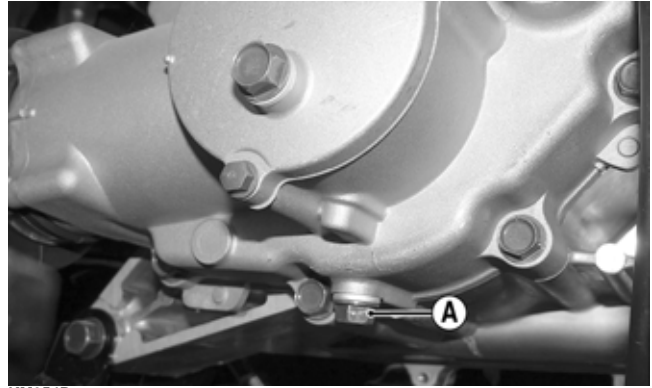

KM954B

■NOTE: If the engine has not been removed, remove the swing arm assembly (see Drive System — Rear Drive Axle — REMOVING).

2. Using a crisscross pattern, remove four cap screws securing the secondary driven bevel gear assembly to the transmission case cover; then remove the assembly. Account for an O-ring.

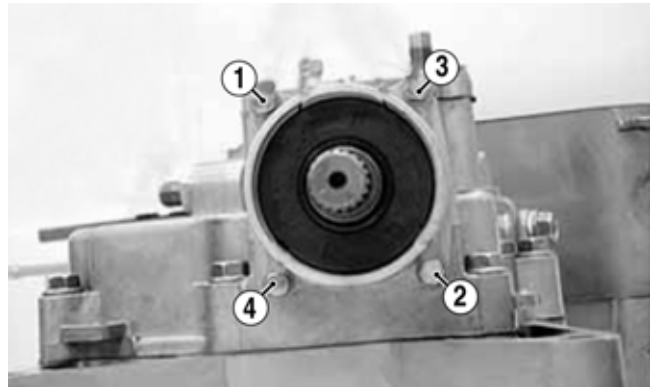

KM646A

3. Remove the three cap screws securing the secondary drive bevel gear cover; then remove the cover. Account for a gasket.

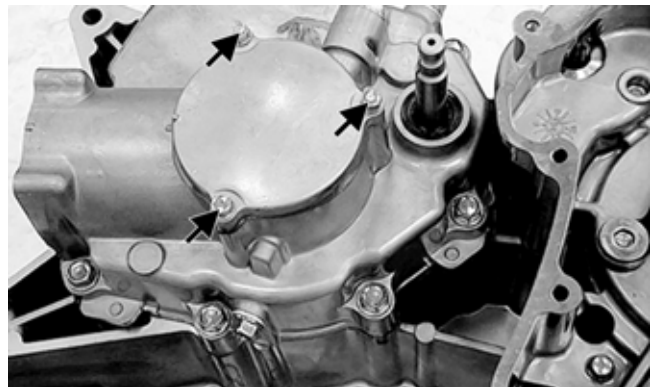

KM648A

- Remove the speedometer gear retainer nut, washer, and speedometer gear.

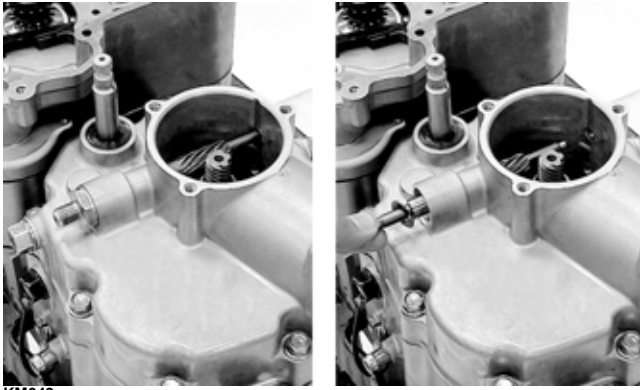

KM649

- Using a Spanner Wrench to hold the centrifugal clutch housing, remove the nut securing the secondary drive bevel gear to the driveshaft.

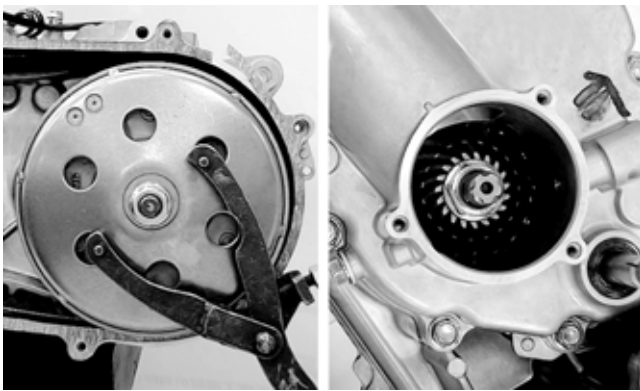

KM650

■NOTE: If the engine has been removed and the left-side components are removed, install the centrifugal clutch housing on the driveshaft. If the left-side components have not been removed, see Removing Left-Side Components in this section. Remove only the V-belt cover.

- Remove the eight cap screws securing the transmission case cover to the transmission case; then remove the cover. Account for a gasket (A), the secondary drive bevel gear, washer (B), and two alignment pins (C).

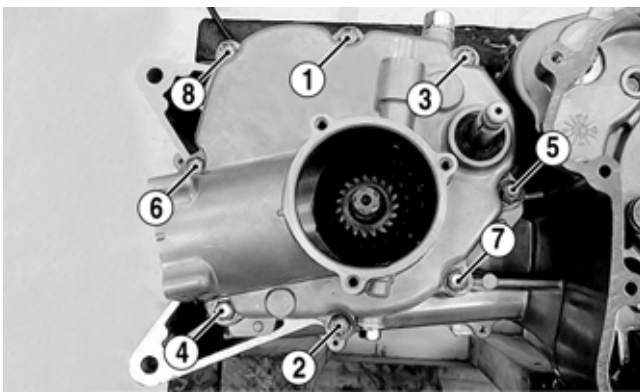

KM651A

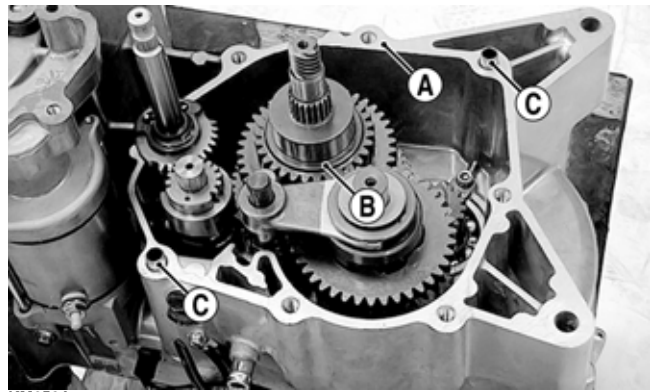

KM652A

- Remove the shift shaft; then remove plug, seal/washer, spring, and shift cam stopper ball.

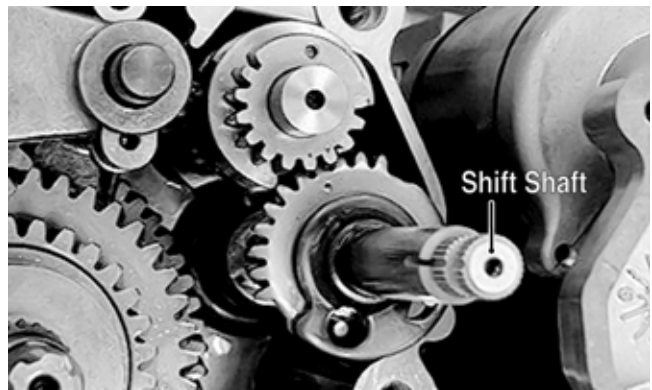

KM677A

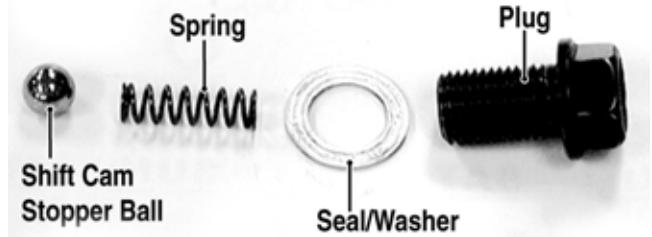

KM619A

- Remove the shift fork guide shaft; then remove the upper shift fork and shift cam.

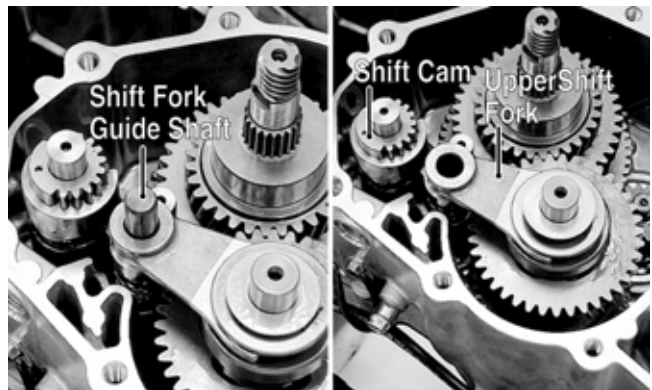

KM679A

- Remove the lower shift fork.

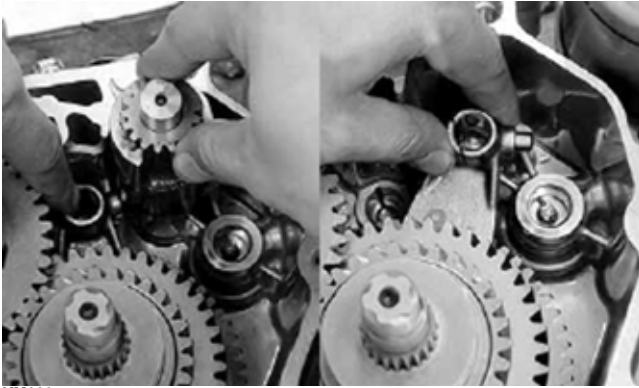

KM680

10. Remove the countershaft and driveshaft as an assembly.

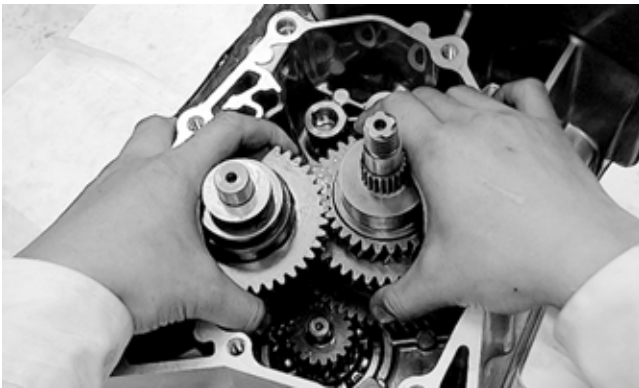

KM681

11. To disassemble the countershaft, use the following procedure:

- A. Remove the thrust washer and high gear clutch dog.

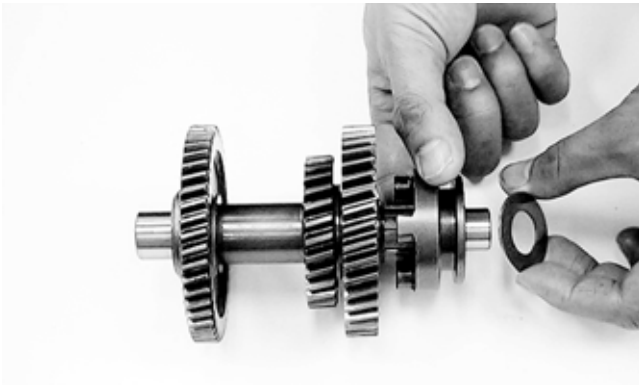

KM684

- B. Remove the high drive gear circlip and washer; then remove the high drive gear and thrust washer.



KM685



12. To disassemble the driveshaft, use the following procedure:

- A. Remove the thrust washer; then remove the reverse gear.

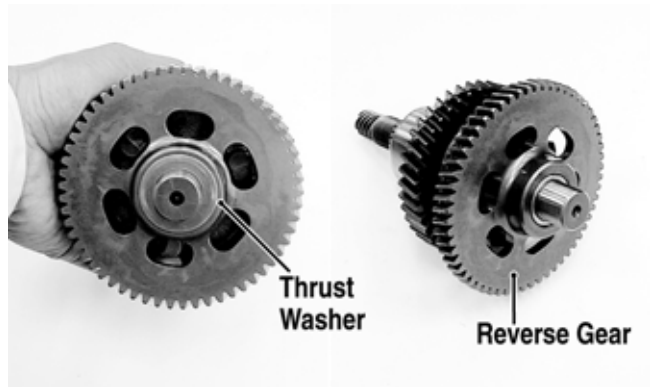

KM689A

- B. Remove a thrust washer and the low/reverse clutch dog.

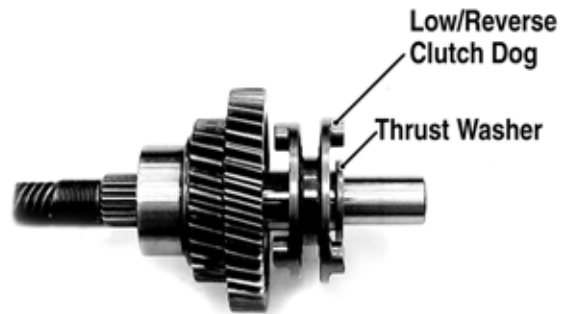

KM690A

- C. Remove the low driven gear snap ring and washer; then remove the low driven gear and thrust washer.



KM692A

13. To disassemble the secondary driven bevel gear assembly, use the following procedure:

- A. Secure the universal joint using a suitable vise; then engage the output end of the shaft with the universal joint.



KM653

- B. Remove the nut securing the driven bevel gear; then remove the gear. Account for a washer.



KM654

- C. Remove the shaft and housing from the universal joint and remove the shaft from the housing.

■NOTE: If left-side components are still attached, remove the centrifugal clutch/driven pulley.

- B. Water Pump
- C. Trigger Coil
- D. Stator Coil
- E. Rotor/Flywheel

AT THIS POINT

To remove/service the water pump, see Fuel/Lubrication/Cooling.

- 14. Remove the right crankcase cover (see Fuel/Lubrication/Cooling — Water Pump).
- 15. Remove the trigger coil mounting screws; then remove the wire set plate.

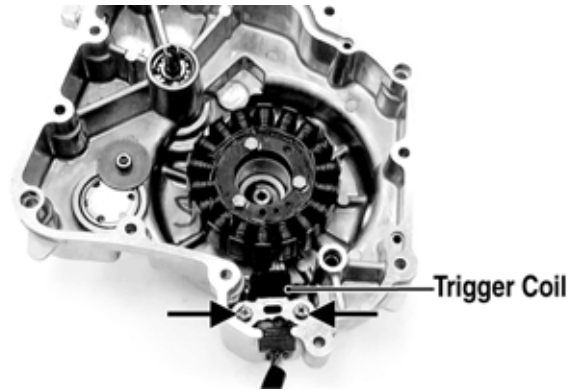

KM772A

- 16. Remove the three cap screws securing the stator coil to the crankcase cover; then remove the stator coil and trigger coil.

CAUTION

Use extreme care to avoid damaging or shorting the wiring.

- 17. Remove the oil-through and spring from the end of the crankshaft; then hold the rotor/flywheel with an appropriate holding tool and remove the flywheel nut and washer.



KM774

- 18. Install the flywheel puller and crankshaft protector; then remove the rotor/flywheel. Account for a key and the starter one-way clutch bearing.



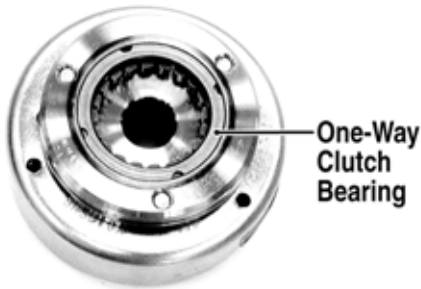

KM775



KM766A

■NOTE: The starter one-way clutch bearing is direction oriented and will only function if installed properly. Note the markings or arrows when removed.

 AT THIS POINT
To service the stator coil, see Electrical System.
 AT THIS POINT
To service the trigger coil, see Electrical System.

F. Oil Pump

■NOTE: Steps 14-18 in the preceding sub-section must precede this procedure.

19. Remove the rotor/flywheel (see E. Rotor/Flywheel in this sub-section).
20. Remove the starter drive gear and place together with the rotor/flywheel to keep the one-way clutch bearing intact.



KM767A

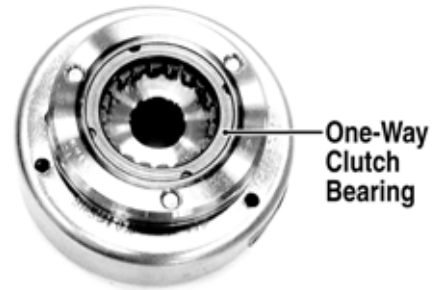

KM766A

21. Remove the two cap screws securing the oil baffle to the crankcase and remove the baffle; then remove the snap ring securing the oil pump driven sprocket.

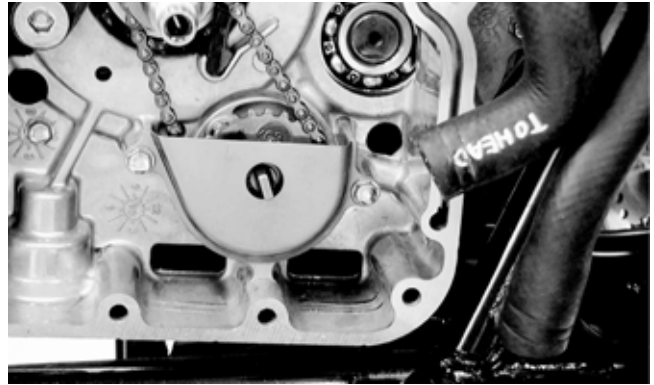

KM428



KM429

22. Remove the oil pump drive chain and oil pump driven sprocket.
23. Remove the two cap screws securing the oil pump to the crankcase and remove the oil pump.

Servicing Right-Side Components

TRANSMISSION

Inspecting

1. Measure the shift fork guide shaft runout. If runout exceeds 0.001 in (0.03 mm), the shaft must be replaced.

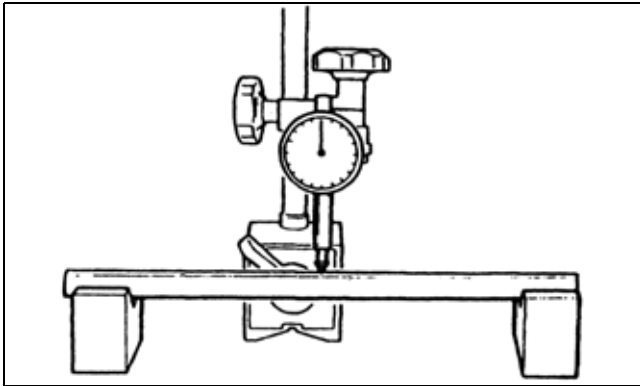

KM623

2. Inspect the shift forks for distortion, discoloration, or excessive wear.
3. Inspect the shift cam groove and shift cam gear for excessive wear.

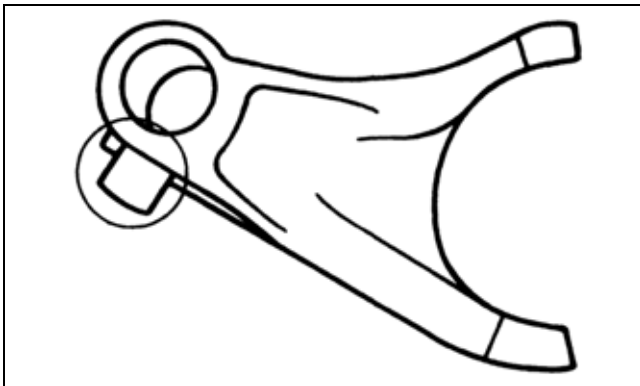

KM624

4. Inspect the shift shaft and gear for excessive wear. Check that the spring is not broken.



KM683

5. Inspect all gear teeth for chipping, discoloration, pitting, or excessive wear. Replace as required.

6. Inspect clutch dogs and mating surfaces for chipping, rounding, or excessive wear. Replace as required.
7. Inspect all bearings, bushings, seals, and shafts for proper fit, surface mating, or discoloration. Replace as required.
8. Inspect transmission housing and cover for cracks, scoring or galling of bearing bores, or case discoloration.
9. Inspect the drive and driven bevel gears for chipping, flaking, or excessive wear in the splines. Replace as required.



KM422

10. Inspect the secondary driven bevel gear housing for cracks, loose bearings, or signs of discoloration from heat. Replace as required.
11. Inspect the driven shaft for scoring, discoloration, or worn splines.



KM421

SECONDARY GEARS

Checking Backlash

1. Remove the secondary drive bevel gear cover.
2. Mount a dial indicator so as to allow the tip to contact the secondary driven bevel gear.
3. Mount the indicator tip of the dial indicator on the secondary driven bevel gear (centered on the gear tooth).
4. While rocking the driven bevel gear back and forth, note the maximum backlash reading on the gauge.
5. Acceptable backlash range is 0.03-0.15 mm (0.001-0.006 in).

Correcting Backlash

■NOTE: If backlash measurement is within the acceptable range, no correction is necessary.

1. If backlash measurement is less than specified, remove an existing driven bevel gear shim, measure it, and install a new thinner shim.
2. If backlash measurement is more than specified, remove an existing driven bevel gear shim, measure it, and install a thicker shim.

■NOTE: Continue to remove, measure, and install until backlash measurement is within tolerance. Note the following chart.

Backlash Measurement	Shim Correction
Under 0.03 mm (0.001 in)	Decrease Shim Thickness
At 0.03-0.15 mm (0.001-0.006 in)	No Correction Required
Over 0.15 mm (0.006 in)	Increase Shim Thickness

Checking Tooth Contact

■NOTE: After correcting backlash of the secondary driven bevel gear, it is necessary to check tooth contact.

1. Remove the secondary driven output shaft assembly from the left-side crankcase half.
2. Clean the secondary driven bevel gear teeth of old oil and grease residue.
3. Apply a thin, even coat of a machinist-layout dye to several teeth of the gear.
4. Rotate the secondary driven bevel gear several revolutions in both directions.
5. Examine the tooth contact pattern in the dye and compare the pattern to the illustrations.

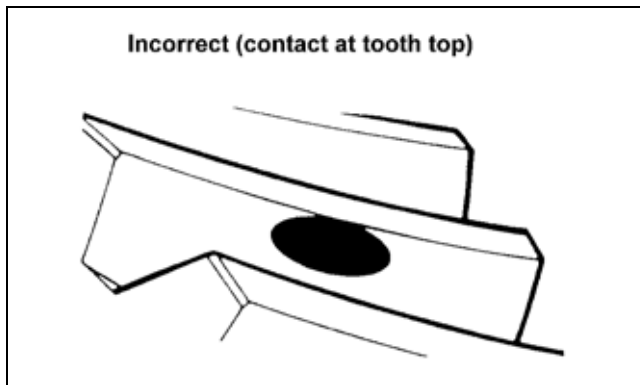

ATV-0103

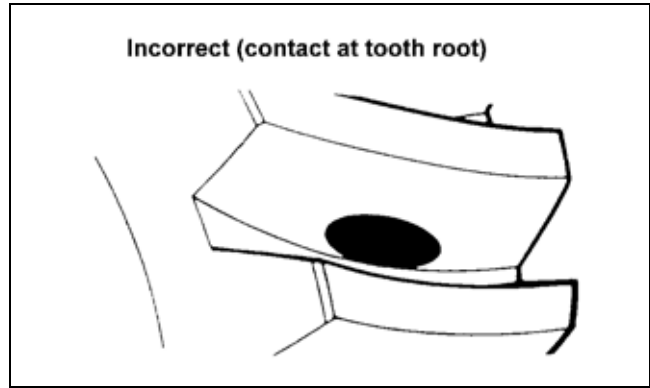

ATV-0105

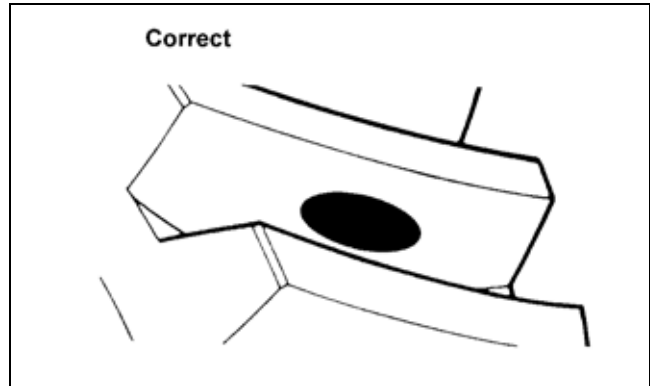

ATV-0104

Correcting Tooth Contact

■NOTE: If tooth contact pattern is comparable to the correct pattern illustration, no correction is necessary.

If tooth contact pattern is comparable to an incorrect pattern, correct tooth contact according to the following chart.

Tooth Contact	Shim Correction
Contacts at Top	Increase Shim Thickness
Contacts at Root	Decrease Shim Thickness

■NOTE: To correct tooth contact, increase or decrease shims as necessary on both secondary drive and driven gears equally. Use the “Tooth Contact/Shim Correction” chart above for shim selections.

CAUTION

After correcting tooth contact, backlash must again be checked and corrected (if necessary). Continue the correcting backlash/correcting tooth contact procedures until they are both within tolerance values.

Assembling

1. Using the appropriate bearing and seal drivers, install any required bearings and seals in the transmission case and case cover.

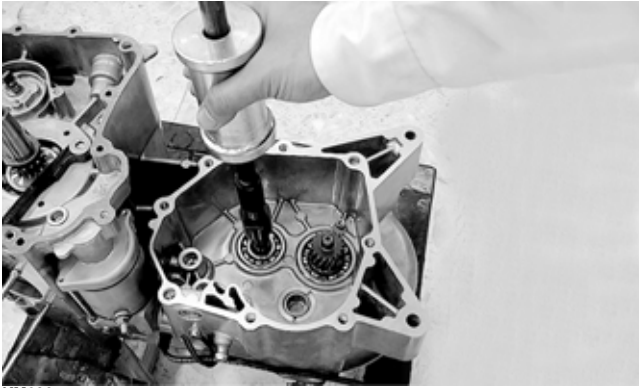

KM696

2. Replace any required bearings and seals in the secondary driven bevel gear shaft case. Apply oil to all seal lips.

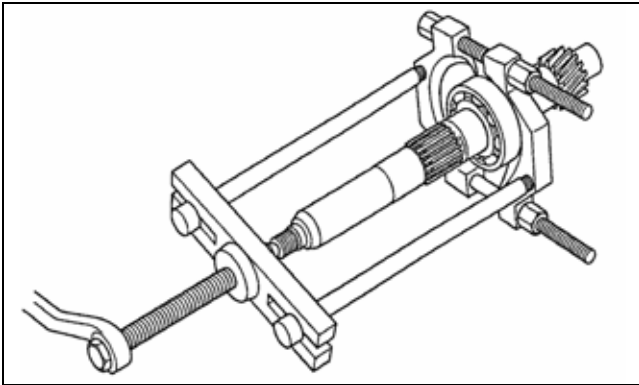

KM695

3. Apply oil to the secondary driven bevel gear shaft; then install the bearing into the case.



KM420

4. Install the flat thrust washer and driven bevel gear on the driven shaft; then using the universal joint and vise to hold the shaft, install a new nut and tighten to 72 ft-lb (97.9 N-m).



KM425

5. Use a center punch to stake the nut to the driven shaft.



KM426A

6. Install the high drive gear thrust washer on the countershaft; then install the high drive gear and secure with a circlip.



KM685A

7. Install the high gear clutch dog and flat washer. At this point, the countershaft is ready for installation.

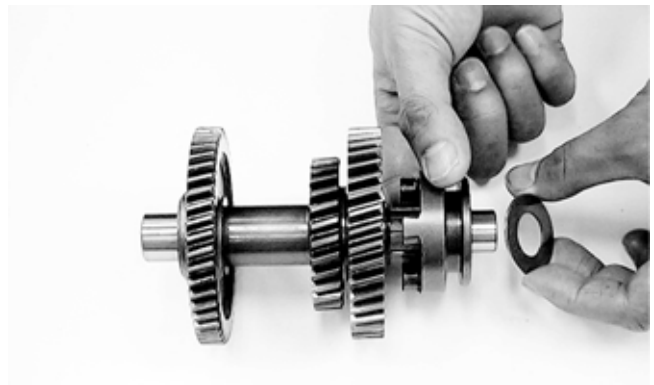

KM684

- Install the low driven gear washer on the driveshaft; then install the low driven gear and thrust washer. Secure with a snap ring.



KM692A

- Install the low/reverse clutch dog and spacer washer; then install the reverse gear and reverse gear thrust washer. At this point, the driveshaft is ready for installation.

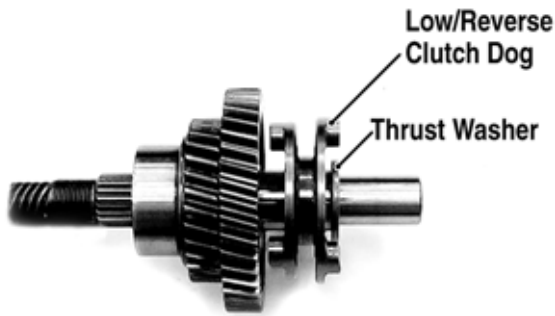

KM690A

- Apply clean engine oil to the assembled shafts and gears; then install the countershaft and driveshaft simultaneously into the transmission case.

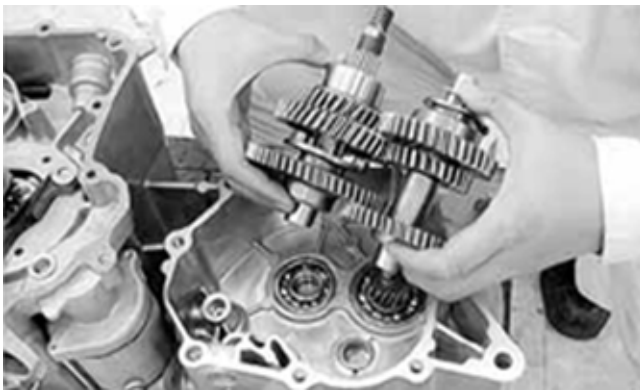

KM699

- Install the low/reverse shift fork into the low/reverse clutch dog; then install the shift cam into the transmission case and engage the shift fork pawl in the appropriate shift cam groove.

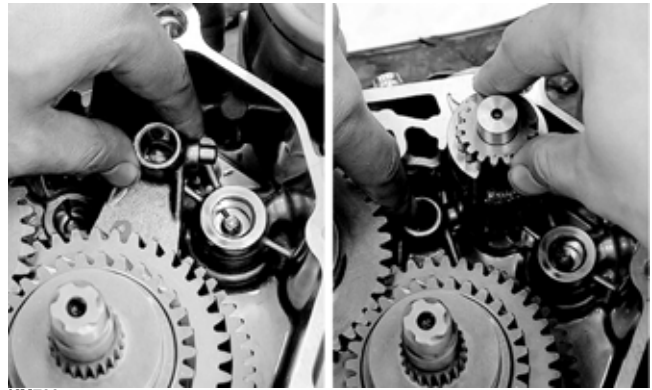

KM700

- Install the high shift fork into the high clutch dog; then engage the shift fork pawl into the appropriate shift cam groove.

- Install the shift fork shaft making sure that the shift fork pawls remain engaged in the shift cam; then install the shift cam stopper ball, spring, seal/washer, and plug (threads coated with red Loctite #271). Tighten to 20 ft-lb (27.2 N-m).

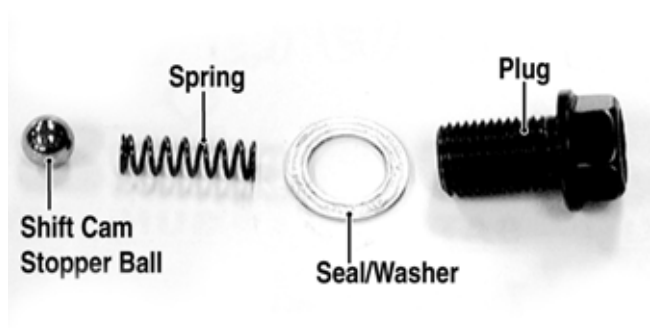

KM619A

- Install the shift shaft making sure to align the timing mark between the two marks on the shift cam.

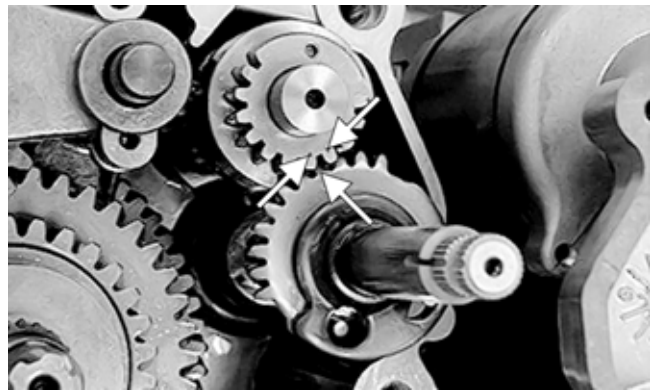

KM702A

- Install the two alignment pins, gasket, and transmission case cover and secure with eight cap screws. Tighten in a crisscross pattern to 20 ft-lb (27.2 N-m).

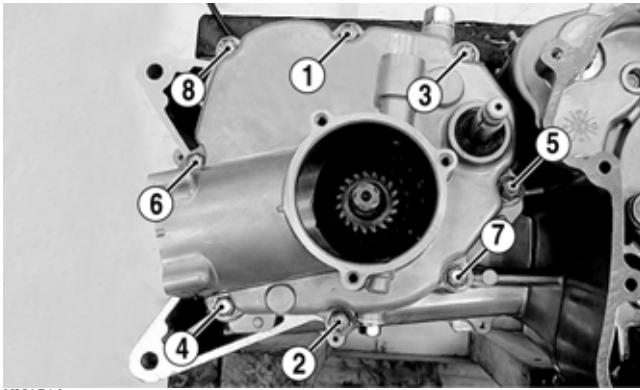

KM651A

16. Install a spacer washer and the drive bevel gear on the driveshaft; then while holding the centrifugal clutch housing with an appropriate holder, secure the bevel gear with a new nut and tighten to 72 ft-lb (97.9 N-m).

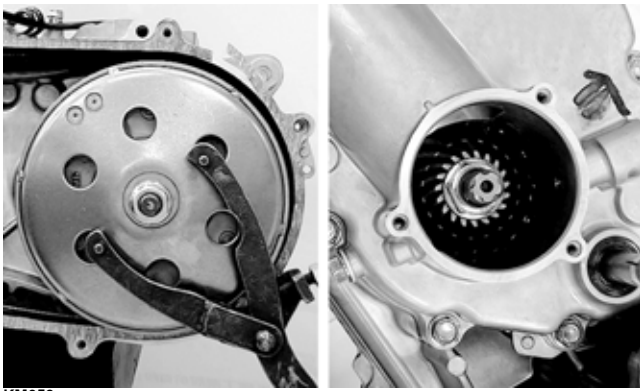

KM650

17. Use a center punch to stake the nut to the driveshaft.
 18. Apply clean engine oil to a new O-ring and install in the groove of the secondary driven bevel gear housing; then with the index marks aligned, install the secondary driven bevel gear assembly in the transmission case.

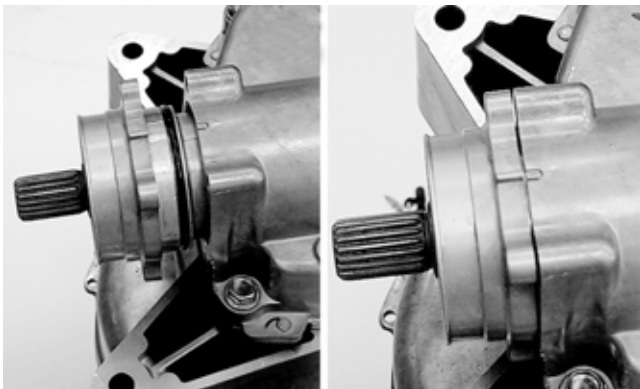

KM673

19. Loosely secure the secondary driven bevel gear assembly using the four cap screws; then using a crisscross pattern, tighten the cap screws until fully seated in the transmission housing.

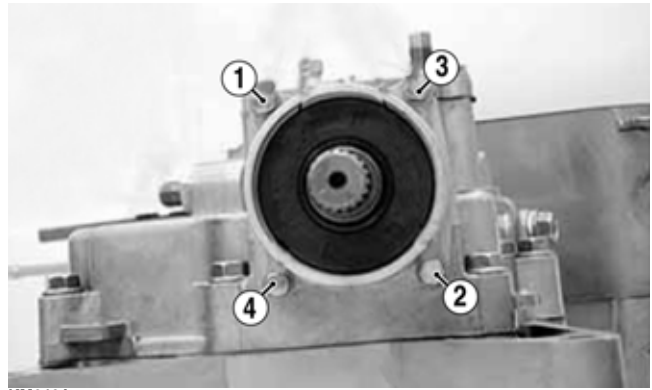

KM646A

Installing Right-Side Components

A. Oil Pump

1. Install the oil pump with the arrow on the pump body directed upward; then secure with the two cap screws and tighten securely. Make sure the shaft turns freely after installing.

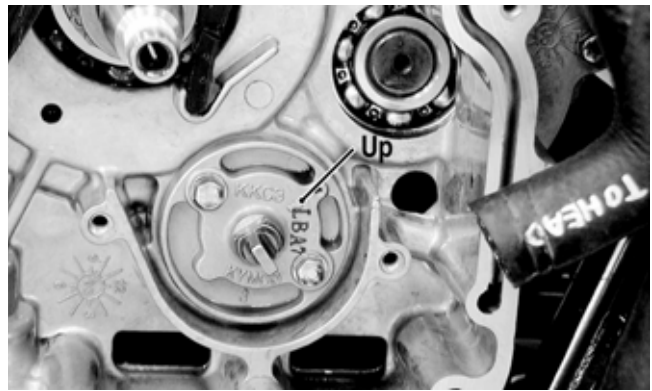

KM434A

2. Install the oil pump driven sprocket and drive chain; then secure the driven sprocket with a snap ring.
 3. Install the oil pump baffle and tighten the cap screws securely.

B. Rotor/Flywheel

C. Trigger Coil

D. Stator Coil

4. Install the starter idler shaft and gear in the crankcase; then install the starter driven gear on the crankshaft.

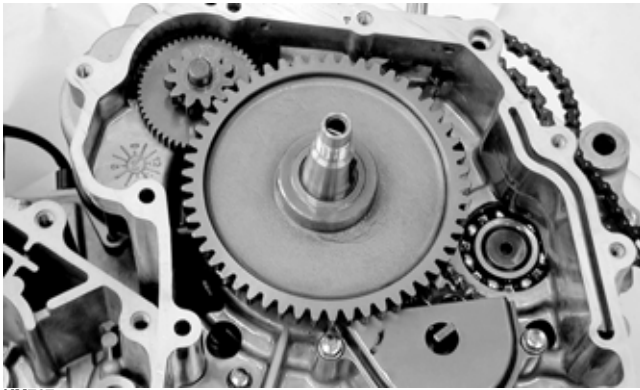

KM767

■NOTE: Make sure the crankshaft and rotor/flywheel contact surfaces are clean and dry before installing the flywheel.

5. Install the key in the crankshaft; then with the starter one-way bearing correctly installed, place the rotor/flywheel onto the crankshaft and position the aligning keyway with the key.
6. Secure the rotor/flywheel on the crankshaft with the nut and tighten to 47 ft-lb (63.9 N-m); then install the spring and oil-through in the crankshaft.

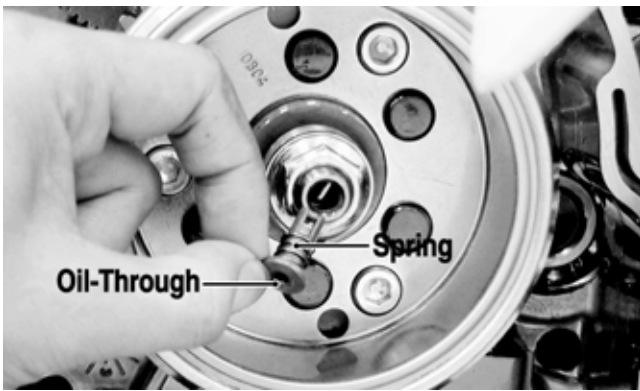

KM773A

7. Install the trigger coil and stator coil in the right-side crankcase cover; then secure with the existing hardware and tighten securely.

E. Water Pump

👉 AT THIS POINT

To install the water pump, see Fuel/Lubrication/Cooling.

F. Transmission

See Servicing Right-Side Components in this sub-section.

Center Crankcase Components

■NOTE: This procedure cannot be done with the engine/transmission in the frame. Complete Removing procedures for Top-Side, Left-Side, and Right-Side must precede this procedure.

■NOTE: For efficiency, it is preferable to remove and disassemble only those components which need to be addressed and to service only those components. The technician should use discretion and sound judgment.

Separating Crankcase Halves

1. Remove the left-side and right-side cap screws securing the crankcase halves noting the position of the different-sized cap screws for joining purposes.

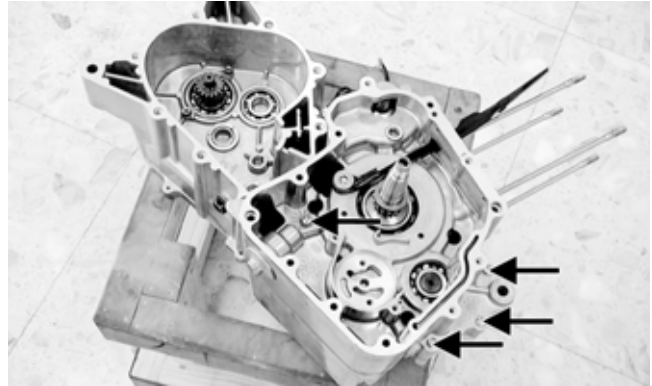

KM720A

2. Using Crankcase Separator/Crankshaft Remover and tapping lightly with a rubber mallet, separate the crankcase halves. Account for two alignment pins and a gasket.

Disassembling Crankcase Half

1. Remove the crankshaft from the left crankcase half.

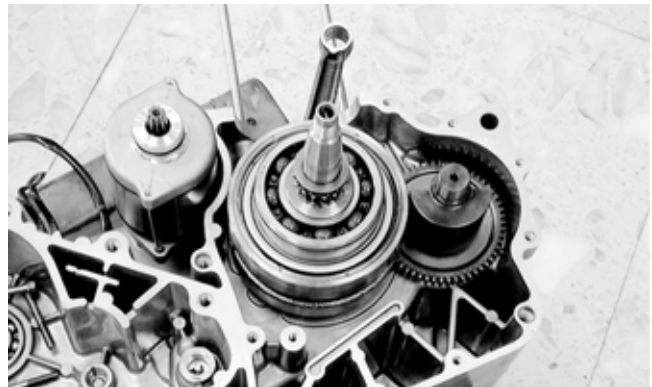

KM721

2. Remove the balancer shaft from the left crankcase half.

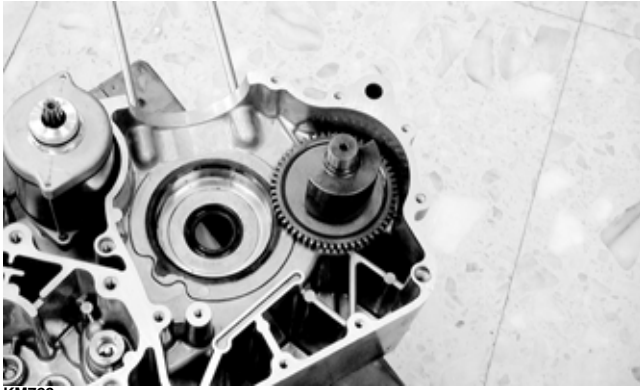

KM722

AT THIS POINT

To service crankshaft assembly, see Servicing Center Crankcase Components sub-section.

Servicing Center Crankcase Components

CRANKSHAFT ASSEMBLY

Measuring Connecting Rod (Small End Inside Diameter)

1. Insert a snap gauge into the upper connecting rod small end bore; then remove the gauge and measure it with micrometer.

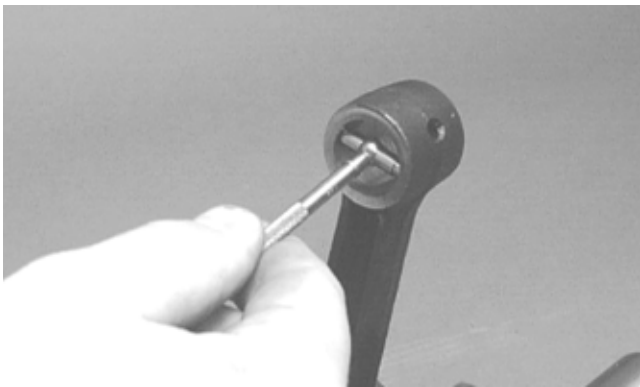

CC290D

2. Maximum diameter must not exceed specifications.

Measuring Connecting Rod (Small End Deflection)

1. Place the crankshaft on a set of V-blocks and mount a dial indicator and base on the surface plate. Position the indicator contact point against the center of the connecting rod small end journal.
2. Zero the indicator and push the small end of the connecting rod away from the dial indicator.
3. Maximum deflection must not exceed specifications.

Measuring Connecting Rod (Big End Side-to-Side)

1. Push the lower end of the connecting rod to one side of the crankshaft journal.

2. Using a feeler gauge, measure the gap between the connecting rod and crankshaft journal.

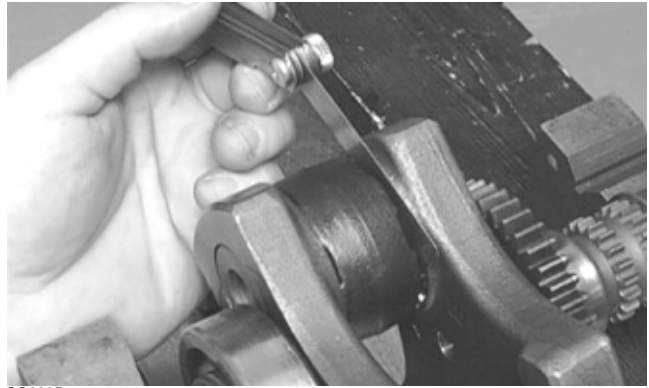

CC289D

3. Acceptable gap range must be within specifications.

Measuring Crankshaft (Runout)

1. Place the crankshaft on a set of V blocks.
2. Mount a dial indicator and base on the surface plate. Position the indicator contact at point 1 of the crankshaft.

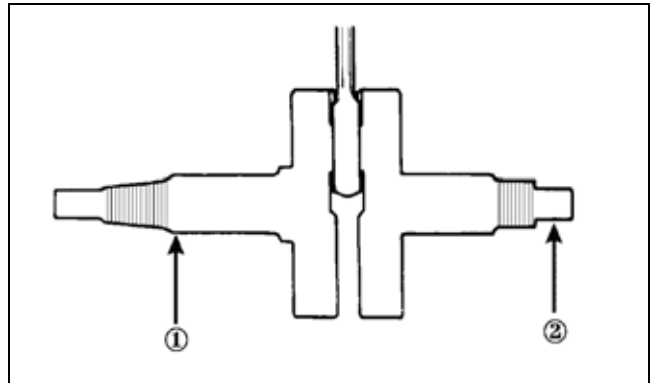

ATV-1074

3. Zero the indicator and rotate the crankshaft slowly.

CAUTION

Care should be taken to support the connecting rod when rotating the crankshaft.

4. Maximum runout must not exceed specifications.

■NOTE: Proceed to check runout on the other end of the crankshaft by positioning the indicator contact at point 2 and following steps 3-4.

Measuring Crankshaft (Web-to-Web)

1. Using a calipers, measure the distance from the outside edge of one web to the outside edge of the other web.

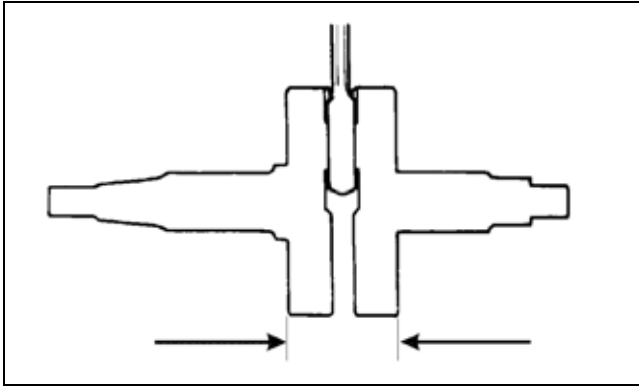

ATV-1017

2. Acceptable width range must be within specifications.

CRANK BALANCER SHAFT

Inspecting

Inspect the gear teeth and bearing surfaces for chips, discoloration, or excessive wear.



KM724

Assembling Crankcase Half

■NOTE: For ease of assembling, install components on the left-side crankcase half.

To assemble center crankcase components, install the balancer shaft into the left-side crankcase half; then align the timing mark on the balancer shaft with the timing mark on the crankshaft. Install the crankshaft.



KM728A

Joining Crankcase Halves

1. Verify that the alignment pins and a new gasket are in place and that both case halves are clean and grease free. Place the right-side half onto the left-side half.
2. Using a plastic mallet, lightly tap the case halves together until cap screws can be installed.
3. From the right side, install the crankcase cap screws noting the location of the different-sized cap screws; then tighten only until snug.

■NOTE: Rotate the crankshaft back and forth to ensure no binding or sticking occurs while tightening the cap screws.

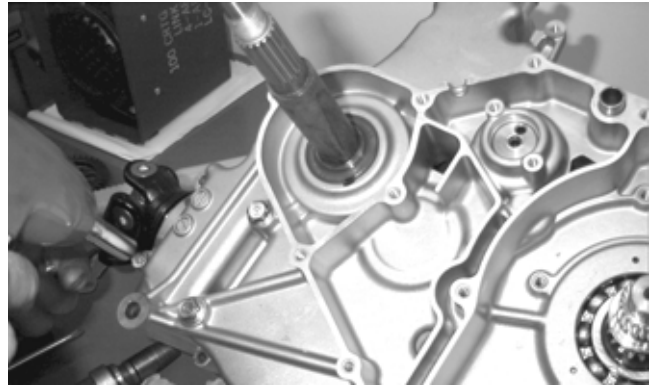

MD1008

4. From the left side, install the remaining crankcase cap screws; then tighten only until snug.

■NOTE: Rotate the crankshaft back and forth to ensure no binding or sticking occurs while tightening the cap screws.

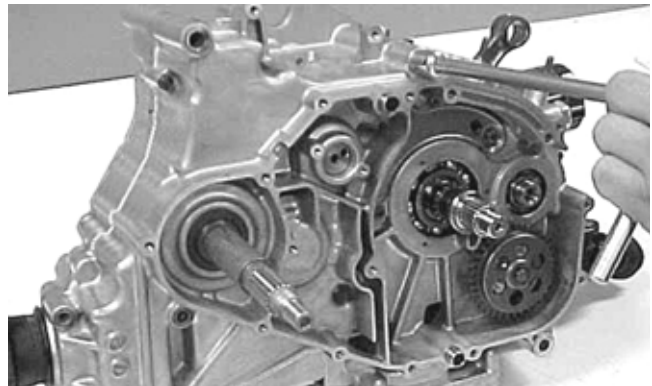

CC871

5. In a crisscross/case-to-case pattern, tighten the cap screws until the halves are correctly joined; then tighten to 8 ft-lb (10.9 N-m).

■NOTE: Rotate the crankshaft back and forth to ensure no binding or sticking occurs.

AT THIS POINT

After completing center crankcase components, proceed to Installing Right-Side Components, to Installing Left-Side Components, and to Installing Top-Side Components.

Installing Engine/Transmission

1. Attach a suitable engine lift to the front engine mounting boss; then lift the engine/transmission assembly into the frame from the left side. The front of the engine/transmission should go in first.



KM331

2. Lifting the front of the engine/transmission, move the assembly forward sufficiently to clear the rear engine mounts; then engage the secondary bevel driveshaft into the universal joint splines.



KM328

3. Slide the engine/transmission rearward into the rear engine mounts; then install the rear through-bolts and nuts. Do not tighten at this time.
4. Remove the engine lift from the front engine mounting boss; then install the engine mounting brackets to the frame. Finger tighten only.



KM414

5. Install the front engine through-bolt; then tighten the engine mounting brackets to 16 ft-lb (21.8 N-m).

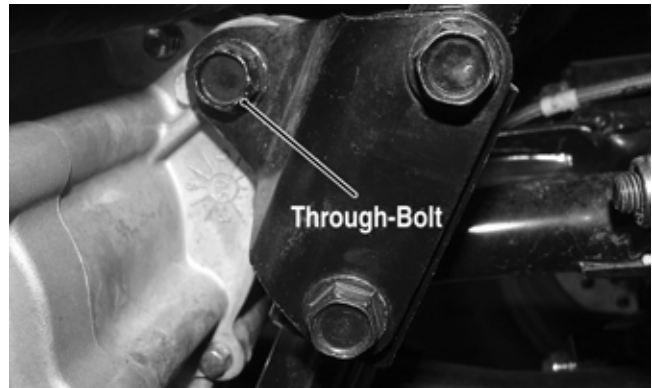

KM414A

6. Tighten the nuts on the two rear and one front through-bolt to 29 ft-lb (39.4 N-m).
7. Connect the shift linkage using the existing hardware.
8. Install the output drive boot onto the bevel driven gear housing and secure with the existing clamp.

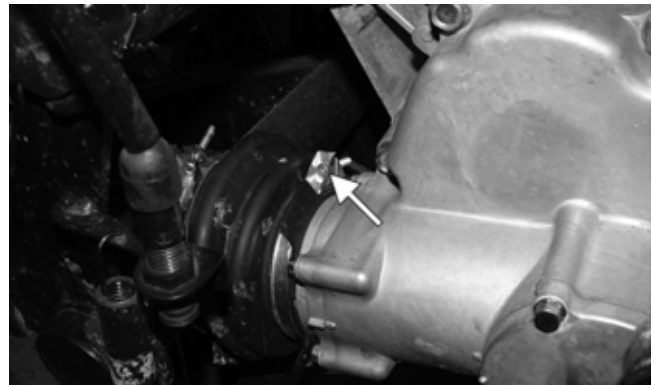

KM315A

9. Connect the V-belt cooling boots to the V-belt housing and secure with the existing hose clamps.

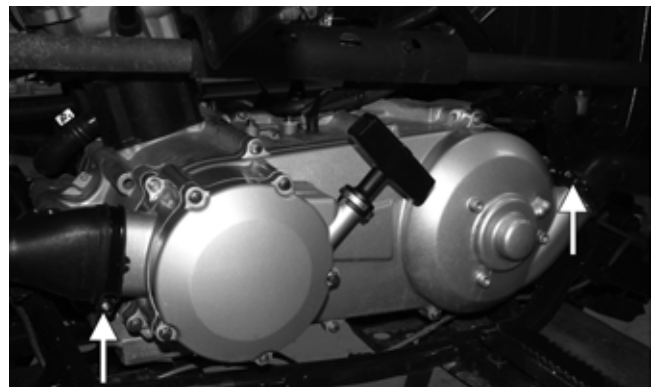

KM307A

10. Connect the engine ground wire to the engine; then connect the starter positive wire to the starter using the existing hardware. Tighten securely.

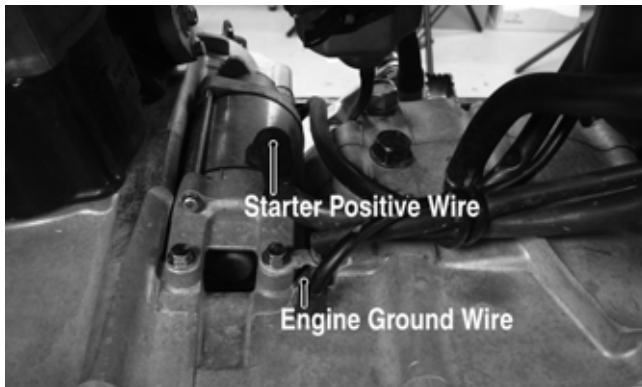

KM319A

11. Connect the coolant temperature sensor; then connect the trigger coil connector, shift position connector, and stator connector.

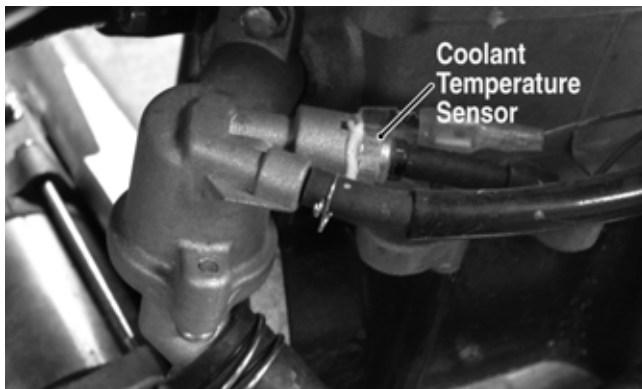

KM324A

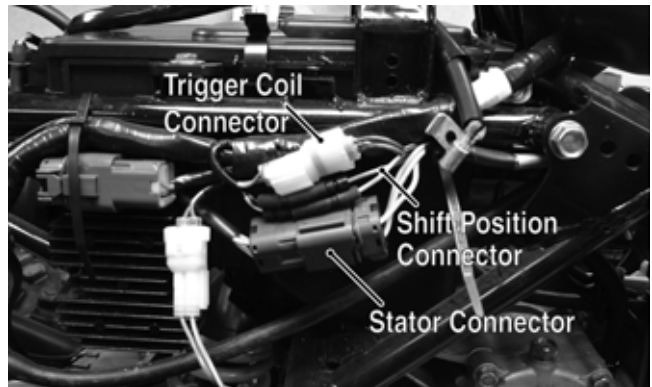

KM347A

12. Install the ignition coil (see Electrical System).
13. Install the carburetor (see Fuel/Lubrication/Cooling).
14. Install the muffler assembly (see Steering/Body/Controls).
15. Install the gas tank and air filter (see Fuel/Lubrication/Cooling).
16. Install the fenders and front rack; then install the side panels (see Steering/Body/Controls).
17. Install the battery; then connect the positive and negative battery cables.
18. Pour in the recommended amount and grade of engine coolant, engine oil, and transmission lubricant.
19. Start the engine and allow it to warm up; then check all fluid levels and add as required.

Fuel/Lubrication/Cooling

Carburetor

⚠ WARNING

Whenever any maintenance or inspection is performed on the fuel system during which there may be fuel leakage, there should be no welding, smoking, open flames, etc., in the area.

REMOVING

1. Remove the seat.
2. Remove the cap screws securing the air filter housing to the frame; then loosen the clamp securing air inlet boot to the carburetor.

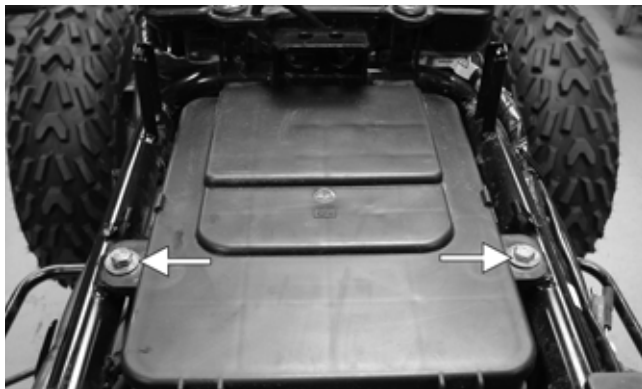

KM320A

3. Turn the gas tank valve off; then clamp and pinch off the fuel inlet hose to the carburetor. Remove the two fasteners securing the gas tank valve to the gas tank mount. Slide the fuel filter off its mount.



KM959

4. Remove the choke assembly from the carburetor leaving the choke cable attached to the choke plunger.

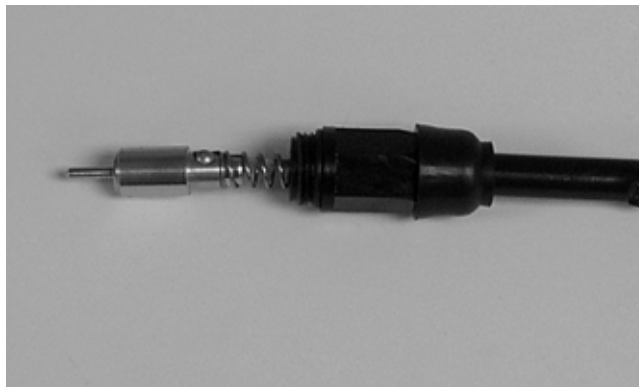

KC0018

5. Remove the screw securing the throttle actuator cover to the carburetor; then remove the cover.

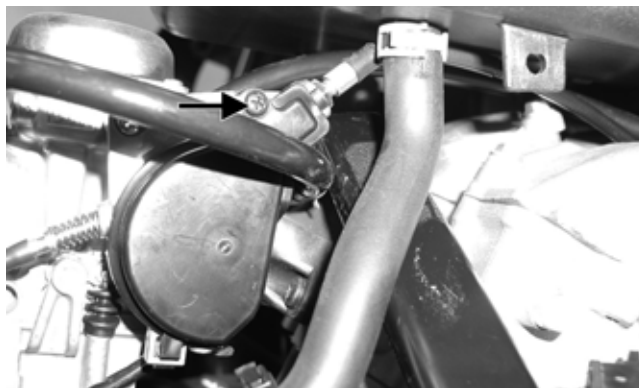

PR154B

6. Remove the throttle cable from the actuator arm.



PR162C

7. Loosen the outer jam nut securing the throttle cable to the carburetor body; then route the cable out of the way.

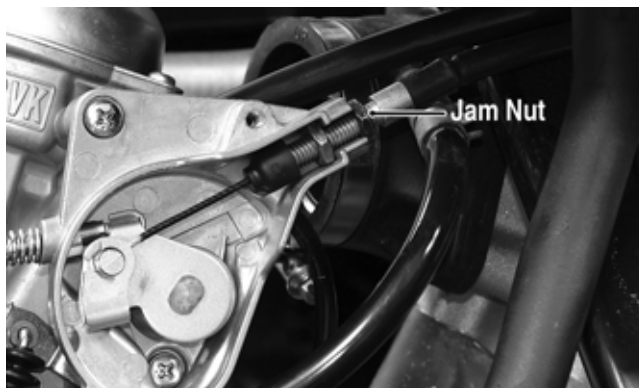

PR162B

8. Disconnect the vent hose; then remove the carburetor.

DISASSEMBLING

1. Remove the four Phillips-head screws securing the top cover; then remove the cover.

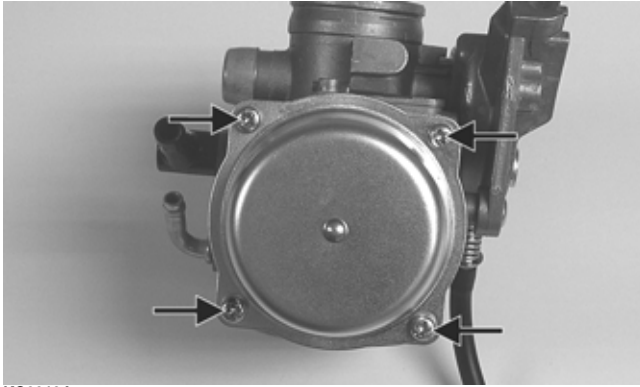

KC0019A

2. Remove the vacuum piston assembly from the carburetor body. Account for a spring, spring seat, and the jet needle.

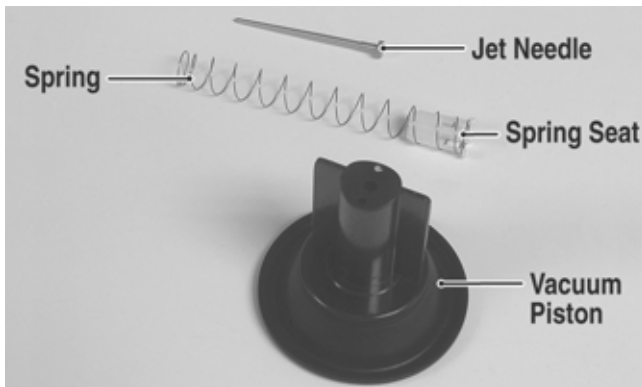

KC0021A

3. Remove the Phillips-head screws securing the float chamber; then remove the chamber. Account for the O-ring.

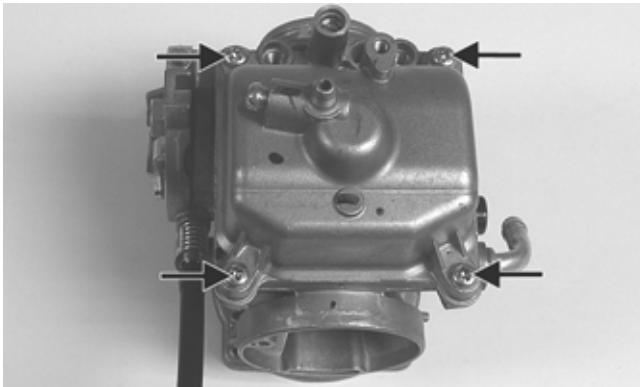

KC0022A

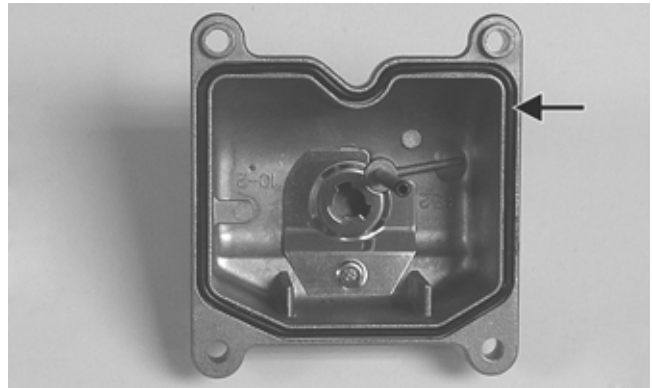

KC0063A

4. Remove the float pin.

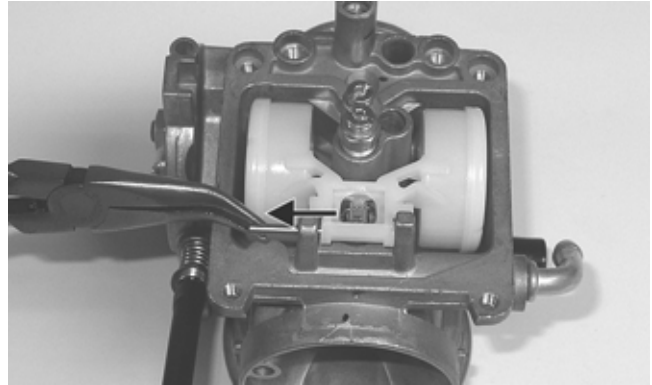

KC0024A

5. Lift the float assembly from the carburetor. Account for the float valve.

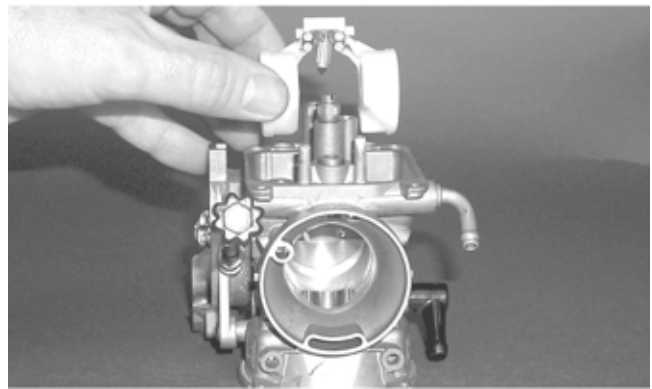

CC753

■NOTE: Note the locations of the jets and holder for disassembling procedures.

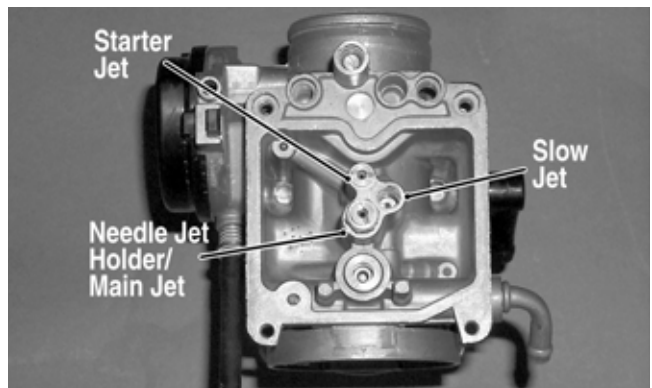

CC761B

- Secure the needle jet holder with a wrench; then remove the main jet.

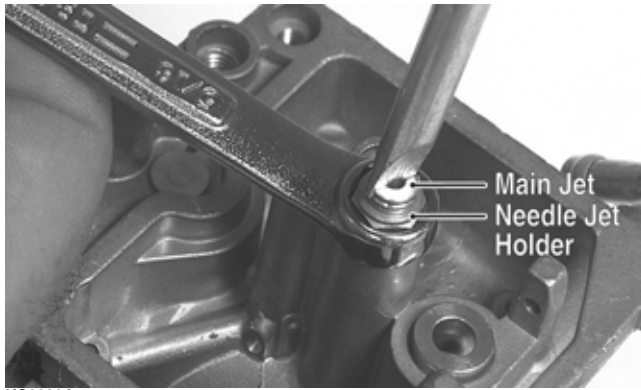

KC0030A

- Remove the needle jet holder; then remove the needle jet, slow jet, and the starter jet.

CLEANING AND INSPECTING

⚠ WARNING

When drying components with compressed air, always wear safety glasses.

CAUTION

DO NOT place any non-metallic components in parts-cleaning solvent because damage or deterioration will result.

- Place all metallic components in a wire basket and submerge in carburetor cleaner.
- Soak for 30 minutes; then rinse with clean, hot water.
- Wash all non-metallic components with soap and water. Rinse thoroughly.
- Dry all components with compressed air only making sure all holes, orifices, and channels are unobstructed.
- Inspect the carburetor body for cracks, nicks, stripped threads, and any imperfections in the casting.
- Inspect the vacuum piston for cracks, imperfections in the casting, or cracks and tears in the rubber.
- Inspect float for damage.
- Inspect gasket and O-rings for distortion, tears, or noticeable damage.
- Inspect tips of the jet needle and the needle jet for wear, damage, or distortion.
- Inspect the slow jet and main jet for obstructions or damage.

■NOTE: If the slow jet is obstructed, the mixture will be extremely lean at idle and part-throttle operation.

- Inspect the float valve for wear or damage.
- Inspect the carburetor mounting flange for damage and tightness.

ASSEMBLING

■NOTE: Note the locations of the jets and holder during assembling procedures.

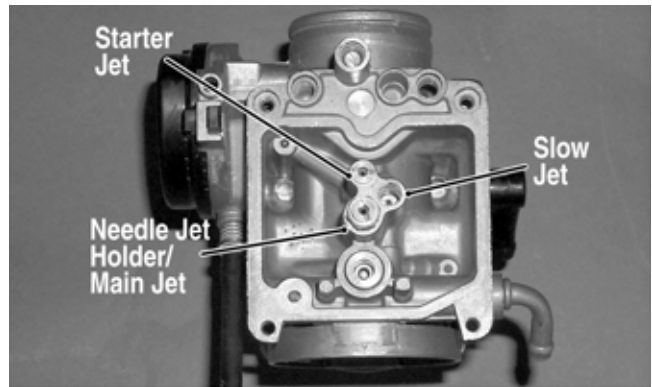

CC761B

- Install the slow jet. Tighten securely.
- Install the main jet into the needle jet holder and tighten securely; then install the needle jet, starter jet, and needle jet holder assembly into the carburetor and tighten securely.
- Place the float assembly (with float valve) into position and secure to the carburetor with the float pin.

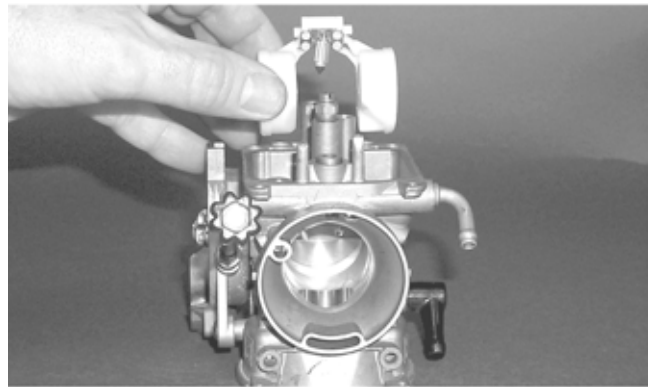

CC753

■NOTE: Check float arm height by placing the carburetor on its side w/float contacting the needle; then measure with a caliper the height when the float arm is in contact with the needle valve. Float arm height should be 0.67 in (17 mm).

- Place the float chamber into position making sure the O-ring is properly positioned; then secure with the Phillips-head screws.

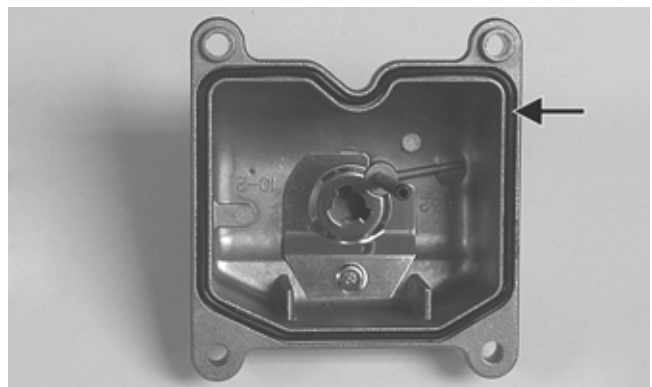

KC0063A

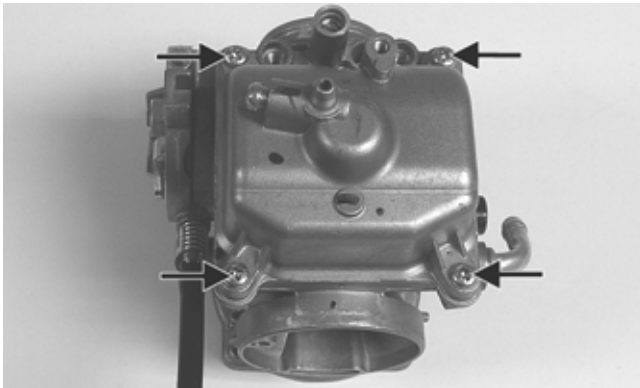

KC0022A

5. Place the jet needle, spring seat, and spring into the vacuum piston; then place the assembly down into the carburetor.
6. Place the top cover into position; then secure with the Phillips-head screws. Tighten securely.

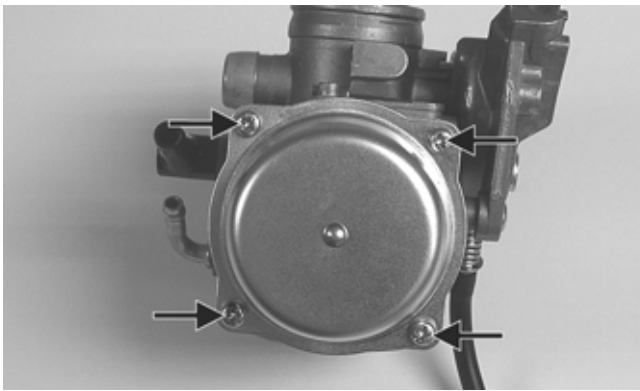

KC0019A

INSTALLING

1. Connect the vent hose onto the carburetor.
2. Place the throttle cable into position and secure by tightening the outer jam nut.



PR162B

3. Connect the throttle cable to the actuator arm.

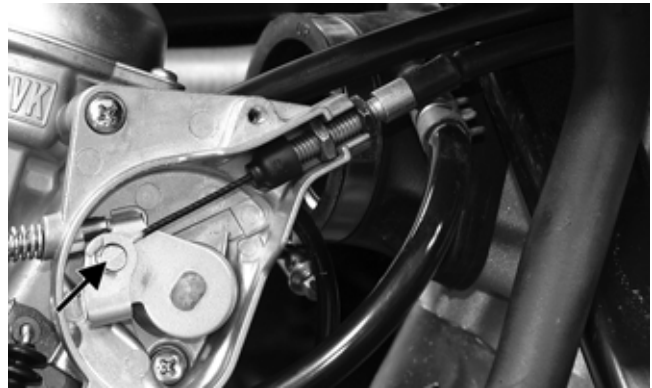

PR162C

4. Place the throttle actuator cover into position on the carburetor; then secure with the screw.

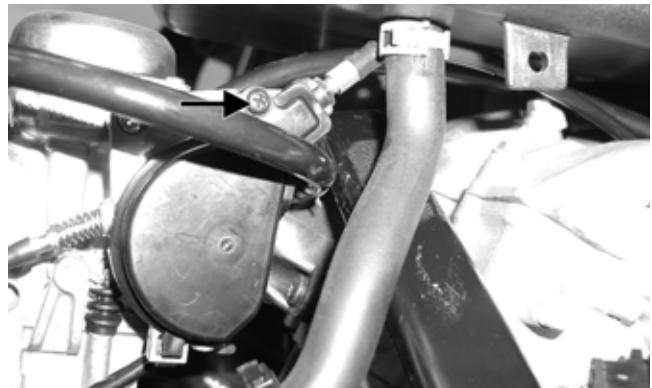

PR154B

5. Connect the choke assembly to the carburetor.
6. Position and install the gas tank valve to the gas tank mount and secure. Install the fuel inlet hose to the carburetor.



KM959

7. Tighten the clamp securing the air inlet boot to the carburetor. Secure the air filter housing to the frame with the cap screws.
8. Install the seat.

Throttle Cable Free-Play

To adjust throttle cable free-play, use the following procedure:

1. Slide the rubber boot away from the adjuster; then loosen the jam nut (1) from the throttle cable adjuster (2).

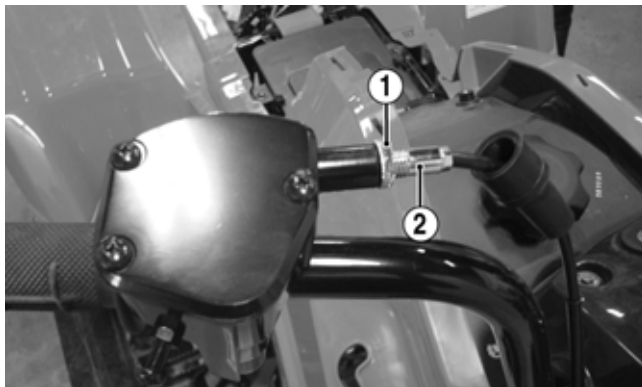

XA087A

2. Turn the adjuster until the throttle cable has proper free-play of 1-4 mm (1/16-3/16 in) at the lever.

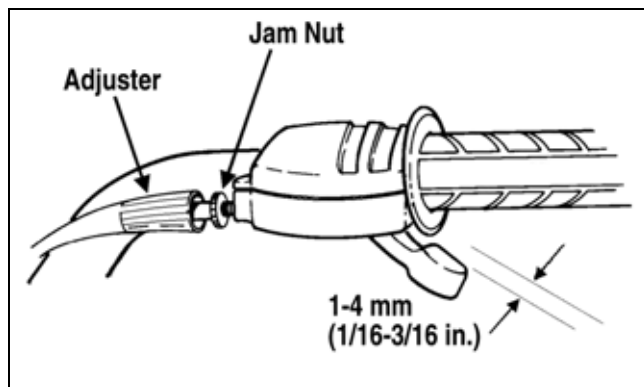

TXA057

3. Tighten the jam nut against the throttle cable adjuster securely; then slide the rubber boot over the adjuster.

Engine RPM (Idle)

To properly adjust the idle RPM, a tachometer is necessary. To adjust idle RPM, use the following procedure:

■**NOTE:** The idle adjustment screw is located on the right side of the carburetor.

1. With the transmission in neutral, start the engine and warm it up to normal operating temperature.
2. Turn the idle adjustment screw clockwise one turn past the recommended RPM setting; then turn it counterclockwise to the correct setting of 1250-1350 RPM.

WARNING

Adjust the idle to the correct RPM. Make sure the engine is at normal operating temperature before adjusting the idle RPM.

Gas Tank

WARNING

Whenever any maintenance or inspection is made on the fuel system during which there may be fuel leakage, there should be no welding, smoking, open flames, etc., in the area.

REMOVING

1. Turn the gas tank valve to the OFF position.
2. Remove the seat; then remove the steering post cover and gas tank cover.
3. Remove the six cap screws securing the front body panel assembly to the frame and gas tank.

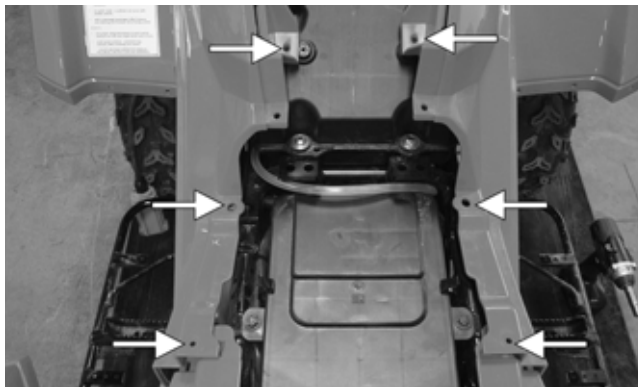

XA077A

4. Clamp and pinch off the fuel inlet hose to the carburetor. Remove the two fasteners securing the gas tank valve to the gas tank mount. Slide the fuel filter off its mount.



KM959

5. Cut the tie-down securing the gas hose to the cables and hoses.
6. Remove the cap screws (A) and nuts (B) securing the gas tank to the frame.

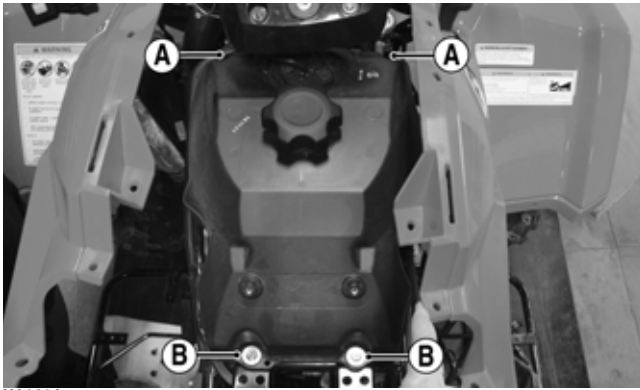

XA086A

7. Disconnect the fuel level sensor connector; then remove the gas tank.

■NOTE: The fuel level sensor connector can be accessed from within the front right fender well.

CLEANING AND INSPECTING

1. Clean all gas tank components with parts-cleaning solvent.
2. Inspect all hoses for cracks or leaks.
3. Inspect gas tank valve, tank cap, and tank for leaks, holes, and damaged threads.
4. Inspect the gas gauge for proper operation.

INSTALLING

1. Place the gas tank into position on the frame; then install the cap screws. Tighten securely.
2. Route the gas hoses into position. Mount the fuel filter and connect the inlet hose to the carburetor. Secure the gas tank valve to the gas tank.
3. Fill the gas tank with gasoline.
4. Turn the gas tank valve to the ON position and inspect for leakage.
5. Install the seat.

Gas Tank Valve

The ATV has a valve attached to the gas tank. There are three positions: ON, RES, and OFF.



KM959

In the OFF position, the valve will not allow gasoline to flow to the carburetor. In the ON position (the normal operating position), gasoline will flow from the tank to the carburetor. In this position, 4.54 L (1.2 U.S. gal) will remain in the tank as a reserve quantity. Moving the valve to the RES position will allow the operator to use the remaining gasoline in the tank. When turning the valve to any of the three positions, make sure the indicator is pointed directly at the position desired.

REMOVING/INSPECTING

⚠ WARNING

Drain the gas tank prior to this procedure.

1. Remove the gas hoses from the valve by releasing the clamps.
2. Remove the two machine screws securing the valve to the gas tank mount; then remove the valve.
3. Inspect the valve/tank mating surfaces for damage or deterioration.
4. Inspect for and remove any obstructions in the valve.

INSTALLING

1. Place the valve into position on the tank bracket and secure with the machine screws. Tighten securely.
2. Install the gas hoses onto the valve with the clamps.

Oil Flow Chart

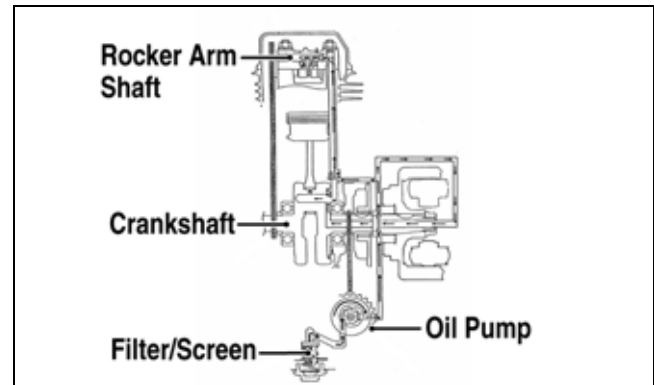

KM427A

Oil Pump

■NOTE: Whenever internal engine components wear excessively or break and whenever oil is contaminated, the oil pump should be disassembled, cleaned, and inspected.

■NOTE: The oil pump is only serviceable as an assembly.

REMOVING/DISASSEMBLING

1. Remove the oil pump from the engine (see Right-Side Components in Engine/Transmission).

2. Remove the Phillips-head screw on the back side of the pump and separate the pump housing and cover. Note the position of the inner and outer rotors and alignment pin for assembly.
3. Remove oil pump components.

CLEANING AND INSPECTING

■NOTE: If any part is worn excessively, cracked, or damaged in any way, the oil pump must be replaced.

1. Clean all oil pump components.
2. Inspect the rotors for scoring and gouges.
3. Inspect the alignment pin, driveshaft, and driven sprocket for damage.
4. Inspect the pump housing and cover for cracks or damage.

ASSEMBLING/INSTALLING

1. Place the rotors into the pump housing making sure the alignment pin is in the groove of the rotor.
2. Place the cover onto the pump housing.
3. Secure the pump with the Phillips-head screw coated with red Loctite #271.
4. Install the oil pump into the engine (see Right-Side Components in Engine/Transmission).

Liquid Cooling System

When filling the cooling system, use pre-mixed anti-freeze. While the cooling system is being filled, air pockets may develop; therefore, run the engine for five minutes after the initial fill, shut the engine off, and fill the coolant overflow tank under the seat to the FULL line.

CAUTION

After operating the ATV for the initial 5-10 minutes, stop the engine, allow the engine to cool down, and check the coolant level. Add coolant as necessary.



KM136A

Radiator

REMOVING

1. Drain the coolant at the engine.

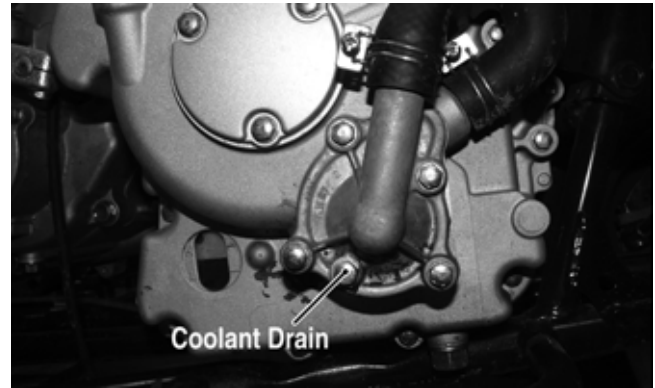

KM314A

2. Remove the front rack; then remove the front cover and fender assembly (see Steering/Body/Controls — Front Rack/Body Panel/Fender).
3. Remove the upper and lower coolant hoses.
4. Remove the cap screws and nuts securing the radiator to the frame.
5. Disconnect the fan wiring from the main wiring harness; then remove the radiator/fan assembly and account for the grommets and collars.
6. Remove the fan/fan shroud assembly from the radiator.

CLEANING AND INSPECTING

1. Flush the radiator with water to remove any contaminants.
2. Inspect the radiator for leaks and damage.
3. Inspect all hoses for cracks and deterioration.
4. Inspect all fasteners and grommets for damage or wear.

INSTALLING

1. Position the fan/fan shroud assembly on the radiator; then secure with existing hardware.
2. Place the radiator with grommets and collars into position on the frame; then install the cap screws and nuts. Tighten securely.
3. Install the upper and lower coolant hoses; then secure with hose clamps.
4. Install the front cover and fender assembly; then install the front rack (see Steering/Body/Controls — Front Rack/Body Panel/Fender).
5. Fill the cooling system with the recommended amount of antifreeze. Check for leakage.
6. Connect the fan wiring to the main wiring harness.

7. Start the engine and run for 3-5 minutes; then check coolant level in the radiator and in the coolant overflow tank and add as required to the appropriate levels.



KM339A



KM136A

8. Install the cover and rack (see Steering/Body/Controls — Front Rack/Body Panel/Fender).

Hoses/Thermostat

REMOVING

1. Drain approximately one U.S. quart of coolant from the cooling system.
2. Remove the two machine screws securing the thermostat housing cover to the thermostat housing. Account for an O-ring and a thermostat.

INSPECTING

1. Inspect the thermostat for corrosion, wear, or spring damage.
2. Using the following procedure, inspect the thermostat for proper operation:
 - A. Suspend the thermostat in a container filled with water.
 - B. Heat the water and monitor the temperature with a thermometer.
 - C. The thermostat should start to open at 78-82° C (172-179° F) and should be full-open at 90° C (194° F).
 - D. If the thermostat does not open, it must be replaced.

3. Inspect all coolant hoses, connections, and clamps for deterioration, cracks, and wear.

INSTALLING

1. Place the thermostat and O-ring into the thermostat housing; then secure the thermostat housing cover to the thermostat housing with the two cap screws. Tighten securely.
2. Fill the cooling system with the recommended amount of antifreeze. Check for leakage.

Fan

REMOVING

1. Remove the radiator.
2. Remove the fan assembly from the radiator.

INSTALLING

1. Position the fan assembly on the radiator; then secure with existing hardware.
2. Install the radiator.

Water Pump

REMOVING/DISASSEMBLING

1. Drain the coolant.
2. Remove the four cap screws securing the water pump case. Account for the gasket and two alignment pins.
3. Remove the impeller, washer, and seal washer.
4. Remove the mechanical seal using the following procedure:
 - A. Tap the tip of a small sheet metal screw into the inner-metal edge of the seal.
 - B. Grip the screw with a pair of vise-grip pliers and pull the seal out. Account for the pump drive seal.

CLEANING AND INSPECTING

1. Clean all pump components in parts-cleaning solvent.
2. Inspect the mechanical seal and pump drive seal for damage.

■NOTE: If the mechanical seal and/or pump drive seal are damaged, they must be replaced as a set.

3. Inspect the impeller for corrosion or damage.

ASSEMBLING/INSTALLING

■NOTE: Treat seals and O-rings with clean anti-freeze for initial lubrication.

1. Press the seal washer into the impeller by hand.

2. Install the water pump drive seal; then drive the mechanical seal into the crankcase cover using an appropriate seal driver.
3. Install the impeller with seal washer onto the water pump shaft and tighten securely.
4. Place the water pump case into position and secure with the four cap screws.

5. Fill the cooling system with the recommended amount of antifreeze.

■**NOTE: While the cooling system is being filled, air pockets may develop; therefore, run the engine for five minutes after the initial fill, shut the engine off, and then fill the cooling system.**

6. Check the entire cooling system for leakage.

Troubleshooting

Problem: Starting impaired	
Condition	Remedy
<ol style="list-style-type: none"> 1. Starter jet obstructed 2. Starter jet passage obstructed 3. Starter body — carburetor leaking air 4. Starter valve not operating properly 	<ol style="list-style-type: none"> 1. Clean jet 2. Clean passage 3. Tighten — adjust — replace gasket 4. Check — adjust valve
Problem: Idling or low speed impaired	
Condition	Remedy
<ol style="list-style-type: none"> 1. Slow jet obstructed — loose 2. Slow jet outlet obstructed 3. Low speed fuel screw setting incorrect 4. Starter valve not fully closed 5. Float height incorrect 	<ol style="list-style-type: none"> 1. Clean — tighten jet 2. Clean outlet 3. Adjust screw 4. Adjust valve 5. Adjust float height
Problem: Medium or high speed impaired	
Condition	Remedy
<ol style="list-style-type: none"> 1. High RPM “cut out” against RPM limiter 2. Main jet obstructed 3. Needle jet obstructed 4. Throttle vacuum piston not operating properly 5. Filter obstructed 6. Float height incorrect 7. Starter valve not fully closed 	<ol style="list-style-type: none"> 1. Shift into higher gear — decrease RPM speed 2. Clean main jet 3. Clean needle jet 4. Check piston operation 5. Clean filter 6. Adjust float height 7. Adjust valve
Problem: Overflow and fuel level fluctuations	
Condition	Remedy
<ol style="list-style-type: none"> 1. Float valve worn — damaged 2. Float valve spring broken 3. Float not working properly 4. Float valve dirty 5. Float height too high — too low 	<ol style="list-style-type: none"> 1. Replace valve 2. Replace spring 3. Adjust float height — replace float 4. Clean valve 5. Adjust float height

Electrical System

This section has been organized into sub-sections which show procedures for the complete servicing of the ATV electrical system.

The electrical connections should be checked periodically for proper function. In case of an electrical failure, check fuses, connections (for tightness, corrosion, damage), and/or bulbs.

SPECIAL TOOLS

A number of special tools must be available to the technician when performing service procedures in this section. Refer to the current Special Tools Catalog for the appropriate tool description.

■NOTE: When indicated for use, each special tool will be identified by its specific name, as shown in the chart below, and capitalized.

Description	p/n
Fluke Model 77 Multimeter	0644-559
MaxiClips	0744-041
Tachometer	0644-275
Timing Light	0644-296

■NOTE: Special tools are available from the Service Parts Department.

TESTING ELECTRICAL COMPONENTS

All of the electrical tests should be made using the Fluke Model 77 Multimeter. If any other type of meter is used, readings may vary due to internal circuitry. When troubleshooting a specific component, always verify first that the fuse(s) are good, that the bulb(s) are good, that the connections are clean and tight, that the battery is fully charged, and that all appropriate switches are activated.

■NOTE: For absolute accuracy, all tests should be made at room temperature of approximately 68° F.

Battery

The battery is located behind the seat.

After being in service, batteries require regular cleaning and recharging in order to deliver peak performance and maximum service life. The following procedure is recommended for cleaning and maintaining a sealed battery. Always read and follow instructions provided with battery chargers and battery products.

■NOTE: Refer to all warnings and cautions provided with the battery or battery maintainer/charger.

Loss of battery charge may be caused by ambient temperature, ignition OFF current draw, corroded terminals, self discharge, frequent start/stops, and short engine run times. Frequent winch usage, snow plowing, extended low RPM operation, short trips, and high amperage accessory usage are also reasons for battery discharge.

Charging/Maintenance Charging

■NOTE: Use of the CTEK Multi US 800 for charging or the CTEK Multi US 3300 for battery maintenance charging is recommended. Maintenance charging is required on all batteries not used for more than two weeks or as required by battery drain.



800A

■NOTE: When charging a battery in the vehicle, be sure the ignition switch is in the OFF position.

1. Clean the battery terminals with a solution of baking soda and water.

■NOTE: The sealing strip should NOT be removed and NO fluid should be added.

2. Be sure the charger and battery are in a well-ventilated area. Be sure the charger is unplugged from the 110-volt electrical outlet.
3. Connect the red terminal lead from the charger to the positive terminal of the battery; then connect the black terminal lead of the charger to the negative terminal of the battery.

■NOTE: Optional battery charging adapters are available from your authorized dealer to connect directly to your vehicle from the recommended chargers to simplify the maintenance charging process. Check with your authorized dealer for proper installation of these charging adapter connectors.

4. Plug the battery charger into a 110-volt electrical outlet.
5. If using the CTEK Multi US 800, there are no further buttons to push. If using the CTEK Multi US 3300, press the Mode button (A) at the left of the charger until the Maintenance Charge Icon (B) or Normal Charge Icon (E) at the bottom illuminates. the Normal Charge Indicator (C) should illuminate on the upper portion of the battery charger.

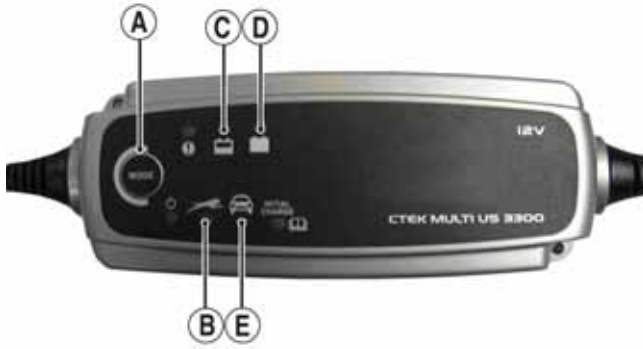

3300C

■NOTE: For optimal charge and performance, leave the charger connected to the battery for a minimum 1 hour after the Maintenance Charge Indicator (D) illuminates. The maintainer/charger will charge the battery to 95% capacity at which time the Maintenance Charge Indicator (D) will illuminate and the maintainer/charger will change to pulse/float maintenance. If the battery falls below 12.9 DC volts, the charger will automatically start again at the first step of the charge sequence. If the battery becomes hot to the touch, stop charging. Resume after it has cooled.

■NOTE: Not using a battery charger with the proper float maintenance will damage the battery if connected over extended periods.

6. Once the battery has reached full charge, unplug the charger from the 110-volt electrical outlet.

■NOTE: If, after charging, the battery does not perform to operator expectations, bring the battery to an authorized dealer for further troubleshooting.

Ignition Switch

The connector is the white one beneath the front cover. To access the connector, the front rack and front cover must be removed (see Steering/Body/Controls).

VOLTAGE

■NOTE: Perform this test on the lower side of the connector.

1. Set the meter selector to the DC Voltage position.
2. Connect the red meter lead to the red/white wire; then connect the black meter lead to ground.
3. The meter must show battery voltage.

■NOTE: If the meter shows no battery voltage, troubleshoot the battery, 30-amp fuse, or the main wiring harness.

RESISTANCE

■NOTE: Perform this test on the upper side of the connector.

1. Turn the ignition switch to the ON position.
2. Set the meter selector to the OHMS position.

3. Connect the red tester lead to the red wire; then connect the black tester lead to the black wire.
4. The meter must show less than 1 ohm.
5. Turn the ignition switch to the LIGHTS position.
6. Connect the red tester lead to the red wire; then connect the black tester lead to the brown wire.
7. The meter must show less than 1 ohm.

■NOTE: If the meter shows more than 1 ohm of resistance, replace the switch.

Ignition Coil

The ignition coil is on the left side of the frame, to the left of the cylinder head. The ignition coil can be accessed through the front left fender well.

RESISTANCE

■NOTE: For these tests, the meter selector must be set to the OHMS position.

Primary Winding

1. Remove the two spade connectors from the coil; then connect the red tester lead to either terminal and the black tester lead to the other terminal.
2. The meter reading must be within specification.

Secondary Winding

1. Connect the red tester lead to the high tension lead (plug cap removed); then connect the black tester lead to ground.
2. The meter reading must be within specification.

■NOTE: If the meter does not show as specified, replace ignition coil.

Spark Plug Cap

1. Connect the red tester lead to one end of the cap; then connect the black tester lead to the other end of the cap.

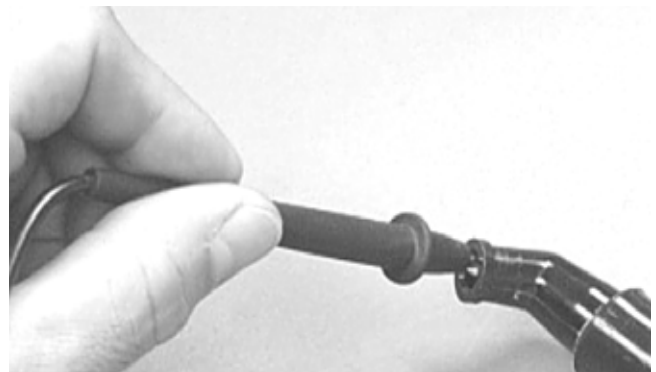

AR603D

2. The meter reading must be within specification.

■NOTE: If the meter does not read as specified, replace the spark plug cap.

Ignition Timing

The ignition timing cannot be adjusted; however, verifying ignition timing can aid in troubleshooting other components. To verify ignition timing, use the following procedure:

1. Attach the Timing Light to the spark plug high tension lead; then remove the timing inspection plug from the left-side crankcase cover.
2. Using the Tachometer, start the engine and run at 1000 RPM; ignition timing should be 5° BTDC ("F" mark).
3. Install the timing inspection plug.

If ignition timing cannot be verified, the rotor may be damaged, the key may be sheared, the trigger coil bracket may be bent or damaged, or the CDI unit may be faulty.

Switches

VOLTAGE (Auxiliary Brake Light)

The switch connector is the two-prong white connector on the right side of the engine directly above the switch.

NOTE: The ignition switch must be in the ON position.

1. Set the meter selector to the DC Voltage position.
2. Connect the red tester to the brown/blue wire; then connect the black tester lead to ground.
3. The meter must show battery voltage.

NOTE: If the meter shows no battery voltage, troubleshoot the battery, fuse, switch, or the main wiring harness.

NOTE: If the meter shows battery voltage, the main wiring harness is good; proceed to test the switch/component, the connector, and the switch wiring harness for resistance.

RESISTANCE (Auxiliary Brake Light)

1. Set the meter selector to the OHMS position.
2. Connect the red tester lead to the brown/blue wire; then connect the black tester lead to the green/yellow wire.
3. When the brake pedal is depressed, the meter must show less than 1 ohm.

NOTE: If the meter shows more than 1 ohm of resistance, replace the switch.

VOLTAGE (Handlebar Brake Light)

The switch has spade-type connectors which engage the harness connectors at the switch.

NOTE: The ignition switch must be in the ON position.

1. Set the meter selector to the DC Voltage position.

2. Connect the red tester lead to the brown/blue wire; then connect the black tester lead to ground.
3. The meter must show battery voltage.

NOTE: If the meter shows no battery voltage, troubleshoot the battery, fuse, switch, or the main wiring harness.

NOTE: If the meter shows battery voltage, the main wiring harness is good; proceed to test the switch/component, the connector, and the switch wiring harness for resistance.

RESISTANCE (Handlebar Brake Light)

NOTE: The brake lever must be compressed for this test. Also, the ignition switch must be in the OFF position.

1. Set the meter selector to the OHMS position.
2. Connect the red tester lead to one spade terminal; then connect the black tester lead to the other spade terminal.
3. When the lever is compressed, the meter must show less than 1 ohm.

NOTE: If the meter shows more than 1 ohm of resistance, replace the switch.

RESISTANCE (HI Beam)

Two white connectors join the handlebar control switch pigtails to the main harness. To access the connectors, the front rack and front cover must be removed (see Steering/Body/Controls — Front Rack/Body Panel/Fender).

NOTE: These tests should be made on the switch side of the connectors with the connectors uncoupled.

1. Set the meter selector to the OHMS position.
2. Connect the red tester lead to the blue wire; then connect the black tester lead to the brown/black wire.
3. With the dimmer switch in the HI position, the meter must show less than 1 ohm.

NOTE: If the meter shows more than 1 ohm of resistance, troubleshoot or replace the switch/component or the connector.

RESISTANCE (LO Beam)

1. Connect the red tester lead to the white wire; then connect the black tester lead to the brown/black wire.
2. With the dimmer switch in the LO position, the meter must show less than 1 ohm.

NOTE: If the meter reads more than 1 ohm of resistance, troubleshoot or replace the switch/component or the connector.

RESISTANCE (Starter Button)

1. Set the meter selector to the OHMS position.
2. Connect the red tester lead to the black/white wire; then connect the black tester lead to the yellow/red wire.
3. With the starter button depressed, the meter must show less than 1 ohm.

4. With the starter button released, the meter must show an open circuit.

■NOTE: If the meter does not show as specified, replace the switch/component or connector.

RESISTANCE (Emergency Stop)

1. Set the meter selector to the OHMS position.
2. Connect the red tester lead to the brown/blue wire; then connect the black tester lead to the black/white wire.
3. With the switch in the OFF position, the meter must show an open circuit.
4. With the switch in the RUN position, the meter must show less than 1 ohm.

■NOTE: If the meter shows more than 1 ohm of resistance, troubleshoot or replace the switch/component or the connector.

RESISTANCE (Reverse Override)

1. Set the meter selector to the OHMS position.
2. Connect the red tester lead to the green/red wire; then connect the black tester lead to the blue/red wire. The meter must show an open circuit.
3. Depress and hold the reverse override button. The meter must show less than 1 ohm of resistance.

■NOTE: If the meter does not show as specified, replace the switch/component or connector.

Fan Motor

The fan motor connector is located directly above the fan. To access the connector, the front rack and front center cover must be removed (see Steering/Body/Controls).

■NOTE: To determine if the fan motor is good, connect the red wire from the fan connector to the positive side of a 12 volt battery; then connect the black wire from the fan connector to the negative side. The fan should operate.

WARNING

Care should be taken to keep clear of the fan blades.

■NOTE: Fan motor resistance checks are not recommended. Resistance values change with the motor commutator position.

Lights

BULB VERIFICATION

Visually inspect the bulb for broken filaments, blackening, or loose bulb base.

VOLTAGE (Headlights)

The two 3-prong connectors are secured to the front bumper supports (one on each side) with cable ties.

■NOTE: Perform this test in turn on the main harness side of the connectors. Also, the ignition switch must be in the LIGHTS position and the engine must be running.

1. Set the meter selector to the DC Voltage position.
2. Connect the red tester lead to the green wire; then connect the black tester lead to the white wire.
3. With the dimmer switch in the LO position (LO beam), the meter must show battery voltage.
4. Connect the red tester lead to the blue wire. With the dimmer switch in the HI position (HI beam), the meter must show battery voltage.

■NOTE: If battery voltage is not shown in any test, inspect the fuses, battery, main wiring harness, connectors, or the left handlebar switch.

VOLTAGE (Taillight)

The 3-prong connector is located under the rear fender assembly.

■NOTE: Perform this test on the main harness side of the connector. Also, the ignition switch should be in the LIGHTS position.

1. Set the meter selector to the DC Voltage position.
2. Connect the red tester lead to the brown/black wire; then connect the black tester lead to the green wire.
3. With the ignition key in the LIGHTS position, the meter must show battery voltage.

■NOTE: If the meter shows no voltage, inspect fuses, wiring harness, connectors, and switches.

VOLTAGE (Brake Light)

■NOTE: Perform this test on the main harness side of the connector. Also, the ignition switch should be in the ON position and the brake (either foot pedal or hand lever) must be applied.

1. Set the meter selector to the DC Voltage position.
2. Connect the red tester lead to the green/yellow wire; then connect the black tester lead to the green wire.
3. With either brake applied, the meter must show battery voltage.

■NOTE: If the meter shows no voltage, inspect fuses, wiring harness, connectors, and switches.

RPM Limiter

■NOTE: The ATV is equipped with a CDI unit that retards ignition timing when maximum RPM is approached. When the RPM limiter is activated, it could be misinterpreted as a high-speed misfire.

Magneto Coils

VOLTAGE (Stator Coil - Output)

■NOTE: This test should be completed with a fully charged battery.

1. Set the meter selector to the AC Voltage position.
2. With the stator wires connected to the harness, perform a total of three tests in between the three wires. With the engine running, the meter should read at least 7-10 AC volts.

CAUTION

Do not run the engine at high RPM for more than 10 seconds.

■NOTE: If voltage is lower than specified, test stator coil - no load.

VOLTAGE (Stator Coil - No Load)

The connector is the black and white one on the right side of the engine just above the brake cable adjuster.

■NOTE: Test the connector that comes from the engine.

1. Set the meter selector to the AC Voltage position.
2. Test between the three yellow wires for a total of three tests.
3. With the engine running at the specified RPM, all wire tests must show as specified.

CAUTION

Do not run the engine at high RPM for more than 10 seconds.

■NOTE: If both voltage tests failed, check all connections, etc., and test again. If no voltage is present, replace the stator assembly.

RESISTANCE (Charging Coil)

1. Set the meter selector to OHMS position.
2. Test between the three yellow wires for a total of three tests.
3. The meter reading must be within specification.

RESISTANCE (Trigger Coil)

1. Set the meter selector to the OHMS position.
2. Connect the red tester lead to the blue/yellow wire; then connect the black tester lead to the green/white wire. The meter reading must be within specification.

Regulator/Rectifier

The regulator/rectifier is located on the right side of the frame. Verify all other charging system components before the regulator/rectifier is replaced.

TESTING

1. Start the engine and warm up to normal operating temperature; then connect a multimeter to the battery as follows.
2. Select the DC Voltage position; then connect the red tester lead to the positive battery post and the black tester lead to the negative battery post.
3. Start the engine and slowly increase RPM. The voltage should increase with the engine RPM to a maximum of 15.5 DC volts.

■NOTE: If voltage rises above 15.5 DC volts, the regulator is faulty or a battery connection is loose or corroded. Clean and tighten battery connections or replace the regulator/rectifier. If voltage does not rise, check Voltage (Stator Coil - No Load) sub-section. If charging coil voltage is normal, replace the regulator/rectifier.

Starter Motor

■NOTE: The starter motor is not a serviceable component. If the starter motor does not operate, see Starter Relay in this section. If the relay tests normal, replace the starter motor.

REMOVING/INSTALLING

1. Disconnect the battery.

CAUTION

Always disconnect the negative battery cable from the battery first; then disconnect the positive cable.

2. Remove the nut securing the positive cable to the starter; then remove the cable from the starter.
3. Remove the two cap screws securing the starter to the crankcase; then remove the starter. Account for the wiring forms and an O-ring.
4. Install the new starter motor.

Starter Relay

VOLTAGE

1. Set the meter selector to the DC Voltage position.
2. Connect the red tester lead to the battery supply terminal (1); then connect the black lead to the starter terminal (2).

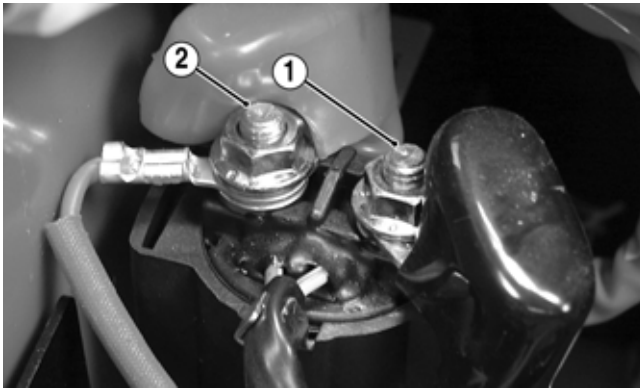

KM458A

3. Turn the ignition switch to the ON position. The meter must read battery voltage.

NOTE: If battery voltage is not shown on the meter, troubleshoot the battery connections, ground connections, and starter cable connections.

4. With the transmission in neutral, depress the starter button. There should be an audible “click” from the starter relay and the meter should show 0 DC volts. If the meter indicates as specified, replace the starter. If there is no audible click and meter reads battery voltage, proceed to step 5.

5. Disconnect the two-wire connector on the starter relay pigtail from the main harness; then on the harness side, connect the red tester lead to the yellow/red wire and the black tester lead to the yellow/green wire.

6. With the transmission in neutral, depress the starter button. The meter must read battery voltage. If battery voltage is indicated, replace the starter solenoid. If no voltage is indicated, troubleshoot the gear position switch, starter button, ignition switch, or harness connectors.

COOLANT TEMPERATURE AND COOLING FAN

1. Connect the meter leads (selector in the OHMS position) to the switch contacts.

2. Suspend the switch and a thermometer in a container of cooking oil; then heat the oil.

NOTE: Neither the switch nor the thermometer should be allowed to touch the bottom of the container or inaccurate readings will occur. Use wire holders to suspend switch and thermometer.

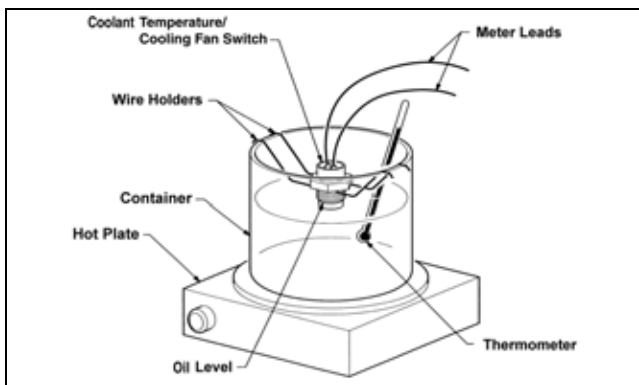

733-554E

3. On the cooling fan switch when the temperature reaches 86-90° C (187-194° F), the meter should read a closed circuit. On the coolant temperature sensor when the temperature reaches 120° C (218° F), the meter should read 16.0 ohms.

4. Allow the oil to cool. On the cooling fan switch when the temperature is within a range of 80-85° C (176-185° F), the meter should read an open circuit. On the coolant temperature sensor, monitor the temperature and resistance as the oil cools. At 100° C (212° F) the meter should read 27 ohms, at 80° C (176° F) 52 ohms, and at 50° C (122° F) 154 ohms.

5. If the readings are not as indicated, the switch must be replaced.

6. Install the switch and tighten securely.

7. Connect the switch leads.

Start-in-Gear Relay

NOTE: The relay schematic is embossed on the relay housing for testing continuity.

NOTE: The module and wiring harness are only serviceable as assemblies.

TESTING

The start-in-gear relay is located under the seat behind the fuse block. To test the relay, use the following procedure:

1. Turn the ignition switch to the ON position; then compress the brake lever or depress the auxiliary brake pedal. There should be an audible “click” from the start-in-gear relay.

NOTE: The brake light should illuminate whenever either brake is applied. If the brake light does not illuminate, troubleshoot the respective brake light switch.

2. Apply the opposite brake from step 1. There should be an audible “click” from the start-in-gear relay.

3. Disconnect the four-wire connector from the start-in-gear relay; then using a voltmeter, connect the red tester lead to the green/yellow wire (1) and the black tester lead to the green wire (3).

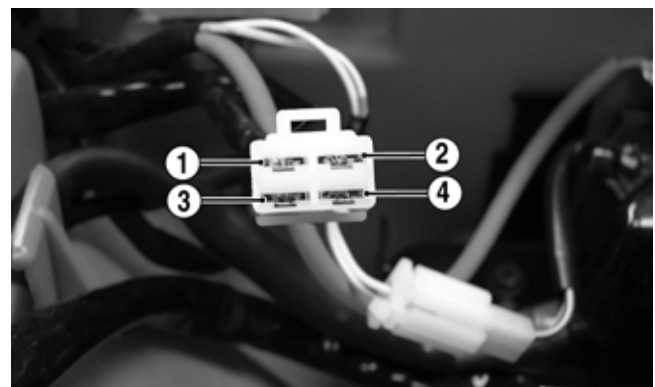

KM460A

4. With the ignition switch in the ON position, select the DC volts position on the tester; then apply either brake. The meter must read battery voltage. If battery voltage is observed and no audible “click” was heard in step 1 or 2, remove the tester leads and replace the start-in-gear relay.
5. Shift the gear selector out of neutral and connect a jumper wire between the yellow/green wire (2) and the green wire (4).

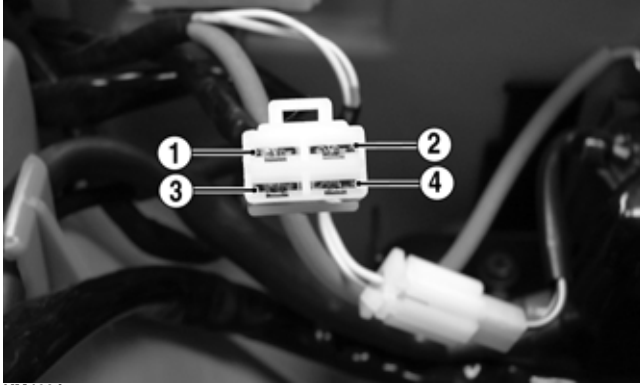

KM460A

6. Momentarily depress the starter button. The starter should engage. If the starter engages, replace the start-in-gear relay. If the starter does not engage, troubleshoot the battery connections, starter relay, or starter connections.

Fuse Block

The fuses are located in a fuse block under the seat.

If there is any type of electrical system failure, always check the fuses first.

■NOTE: To remove a fuse, compress the locking tabs on either side of the fuse case and lift out.



KM102

■NOTE: The ignition switch must be in the LIGHTS position.

1. Remove all fuses from the fuse block.
2. Set the meter selector to the DC Voltage position.
3. Connect the black tester lead to ground.
4. Using the red tester lead, contact each end of the 30-amp fuse holder connector terminals individually.

5. The meter must show battery voltage from one side of the connector terminal ends.
6. Install the 30-amp fuse; then using the red tester lead, check the remaining two fuse holder connectors as in step 4.

■NOTE: Battery voltage will be indicated from only one side of the fuse holder connector terminal; the other side will show no voltage.

■NOTE: If the meter shows no battery voltage, troubleshoot the battery, fuse block, or the main wiring harness.

Fuses

1. Set the meter selector to the OHMS position.
2. Connect the red tester lead to one spade end of the fuse; then connect the black tester lead to the other spade end.



AR610D

3. The meter must show less than 1 ohm resistance. If the meter reads open, replace the fuse.

■NOTE: Make sure the fuses are returned to their proper position according to amperage. Refer to the fuse block cover for fuse placement.

LCD Gauge Assembly

REMOVING

To remove the LCD gauge assembly, see Steering/Body/Controls.

TESTING

■NOTE: If any functions (segments or displays) are not normal or do not display as indicated, the LCD gauge must be replaced.

1. Remove the instrument pod; then disconnect the speedometer cable. Leave the gauge connected to the wiring harness.

■NOTE: To perform the following tests, two MaxiClips and one jumper wire will be required.

2. Connect the black MaxiClip to the green/black wire.

3. Connect the red MaxiClip to the light green/red wire; then connect the jumper between the MaxiClips and turn the ignition switch to the ON position. The neutral indicator light (9) must illuminate.

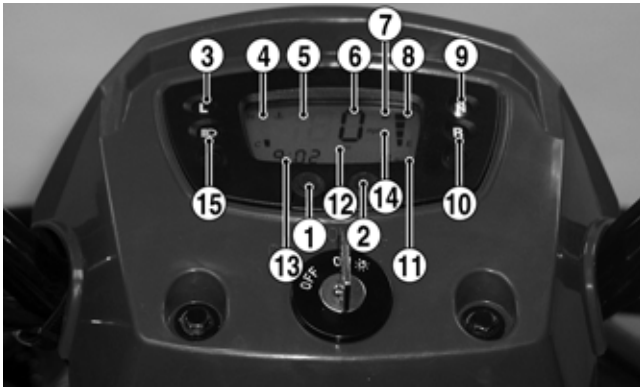

KM123D

4. Connect the red MaxiClip to the blue/red wire. The reverse indicator light (10) must illuminate.
5. Connect the red MaxiClip to the white/red wire. The low range light (3) must illuminate.
6. Connect the red MaxiClip to the green/blue wire. The temperature indicator (4) must indicate hot (all indicator segments visible) and begin flashing. The thermometer icon will also flash.
7. Connect the red MaxiClip to the yellow/white wire. The fuel quantity indicator (8) must sequence (one segment every 8-10 seconds) until the bottom segment begins flashing. After flashing for 8-10 seconds, the bottom segment will extinguish and the gas pump icon (7) will begin flashing.
8. Connect the red MaxiClip to the blue wire; then connect a voltmeter to the MaxiClips (red meter lead to red and black meter lead to black).
9. Set the meter selector to the DC Voltage position; then turn the ignition switch to the LIGHTS position and the light control switch to the HI beam position. The tester must indicate battery voltage and the high beam indicator light (15) must illuminate. If the tester does not read battery voltage, troubleshoot the ignition switch, light control switch, or wiring harness and connectors.
10. Connect the red MaxiClip to the brown/black wire. The tester must read battery voltage and the speedometer backlight (5) must illuminate. If the tester does not read battery voltage, troubleshoot the ignition switch or wiring harness connectors.
11. Depress and hold the Mode/Set button (1). The speedometer should switch between mph and km/h as indicated by icon (12).
12. Depress and hold the Mode/Set button (2). The distance mode should shift between ODO and TRIP as indicated by icon (12).
13. Depress and hold the Mode/Set buttons (1) and (2) simultaneously. The hour segment of the clock should flash indicating the clock (13) is in the set mode. Release the Mode/Set button (2) and release when the desired hour (1-24) appears.
14. Depress and release the Mode/Set button (1) to shift the clock set to the minute segment; then depress Mode/Set button (2) to set the desired minute.

■NOTE: In the clock set mode, the gauge will default to normal operation 10 seconds after the Mode/Set buttons are released.

15. With the ignition switch in the ON position, use a small screwdriver or suitable tool to spin the input quill of the speedometer. The speed indicator (6) must indicate a value greater than zero.

INSTALLING

To install the LCD gauge assembly, see Steering/Body/Controls.

CDI Unit

The CDI is located beneath the seat near the battery.

■NOTE: The CDI unit is only serviceable as an assembly.

The CDI is rarely the cause for electrical problems; however, if the CDI is suspected, substitute another CDI unit to verify the suspected one is defective.

■NOTE: Prior to replacing the CDI unit to ensure the CDI unit is defective, it is advisable to perform a CDI peak voltage test and/or perform a continuity test of the wiring harness from the CDI connector to the CDI unit.

Troubleshooting

Problem: Spark absent or weak	
Condition	Remedy
<ol style="list-style-type: none"> 1. Ignition coil defective 2. Spark plug defective 3. Magneto defective 4. CDI unit defective 5. Pick-up coil defective 	<ol style="list-style-type: none"> 1. Replace ignition coil 2. Replace plug 3. Replace magneto 4. Replace CDI unit 5. Replace pick-up coil
Problem: Spark plug fouled with carbon	
Condition	Remedy
<ol style="list-style-type: none"> 1. Mixture too rich 2. Idling RPM too high 3. Gasoline incorrect 4. Air cleaner element dirty 5. Spark plug incorrect (too cold) 6. Valve seals cracked — missing 7. Oil rings worn — broken 	<ol style="list-style-type: none"> 1. Adjust carburetor 2. Adjust carburetor 3. Change to correct gasoline 4. Clean element 5. Replace plug 6. Replace seals 7. Replace rings
Problem: Spark plug electrodes overheat or burn	
Condition	Remedy
<ol style="list-style-type: none"> 1. Spark plug incorrect (too hot) 2. Engine overheats 3. Spark plug loose 4. Mixture too lean 	<ol style="list-style-type: none"> 1. Replace plug 2. Service cooling system 3. Tighten plug 4. Adjust carburetor
Problem: Magneto does not charge	
Condition	Remedy
<ol style="list-style-type: none"> 1. Lead wires/connections shorted — loose — open 2. Magneto coils shorted — grounded — open 3. Regulator/rectifier defective 	<ol style="list-style-type: none"> 1. Repair — replace — tighten lead wires 2. Replace magneto coils 3. Replace regulator/rectifier
Problem: Magneto charges, but charging rate is below the specification	
Condition	Remedy
<ol style="list-style-type: none"> 1. Lead wires shorted — open — loose (at terminals) 2. Stator coils (charging) grounded — open 3. Regulator/rectifier defective 4. Cell plates (battery) defective 	<ol style="list-style-type: none"> 1. Repair — tighten lead wires 2. Replace stator coils 3. Replace regulator/rectifier 4. Replace battery
Problem: Magneto overcharges	
Condition	Remedy
<ol style="list-style-type: none"> 1. Internal battery short circuited 2. Regulator/rectifier defective 3. Regulator/rectifier poorly grounded 	<ol style="list-style-type: none"> 1. Replace battery 2. Replace regulator/rectifier 3. Clean — tighten ground connection
Problem: Charging unstable	
Condition	Remedy
<ol style="list-style-type: none"> 1. Lead wire intermittently shorting 2. Magneto internally shorted 3. Regulator/rectifier defective 	<ol style="list-style-type: none"> 1. Replace lead wire 2. Replace magneto 3. Replace regulator/rectifier
Problem: Starter button not effective	
Condition	Remedy
<ol style="list-style-type: none"> 1. Battery charge low 2. Switch contacts defective 3. Starter motor brushes not seating 4. Starter relay defective 5. Emergency stop — ignition switch off 6. Wiring connections loose — disconnected 7. Starter bushings worn 8. Starter armature shorted — open 9. Brake switch defective 	<ol style="list-style-type: none"> 1. Recharge — replace battery 2. Replace switch 3. Repair — replace brushes 4. Replace relay 5. Turn on switches 6. Connect — tighten — repair connections 7. Replace starter 8. Replace starter 9. Replace switch
Problem: Battery "sulfation" (Acidic white powdery substance or spots on surfaces of cell plates)	
Condition	Remedy
<ol style="list-style-type: none"> 1. Charging rate too low — too high 2. Specific gravity too low 3. Battery run-down — damaged 4. Electrolyte contaminated 	<ol style="list-style-type: none"> 1. Replace battery 2. Charge battery 3. Replace battery 4. Replace battery
Problem: Battery discharges too rapidly	
Condition	Remedy
<ol style="list-style-type: none"> 1. Electrolyte contaminated 2. Specific gravity too high 3. Battery short-circuited 4. Specific gravity too low 	<ol style="list-style-type: none"> 1. Replace battery 2. Check charging 3. Replace battery 4. Recharge battery
Problem: Battery polarity reversed	
Condition	Remedy
<ol style="list-style-type: none"> 1. Battery incorrectly connected 2. Electrical system damaged 	<ol style="list-style-type: none"> 1. Reverse connections — replace battery 2. Replace damaged components

Drive System

SPECIAL TOOLS

A number of special tools must be available to the technician when performing service procedures in this section. Refer to the current Special Tools Catalog for the appropriate tool description.

NOTE: When indicated for use, each special tool will be identified by its specific name, as shown in the chart below, and capitalized.

Description	p/n
Pivot Lock Nut Wrench	0444-201
Rear Axle Nut Wrench	0444-198
Pinion Gear Bearing Nut Wrench	0444-203
Pinion Puller	0444-202
V Blocks	0644-535

NOTE: Special tools are available from the Service Parts Department.

Rear Drive Axle

REMOVING

1. Secure the ATV on a support stand to elevate the rear wheels.

⚠ WARNING

Make sure the ATV is solidly supported on the support stand to avoid injury.

2. Compress the brake lever and engage the brake lever lock; then remove the rear wheels and hub caps.
3. Remove the cotter pins and rear hub nuts; then remove the hubs.
4. Disengage the brake lever lock; then remove the rear brake calipers and brake disc.

NOTE: Do not apply the brakes with the calipers removed. The brake pistons will be pushed out and brake fluid will be spilled.

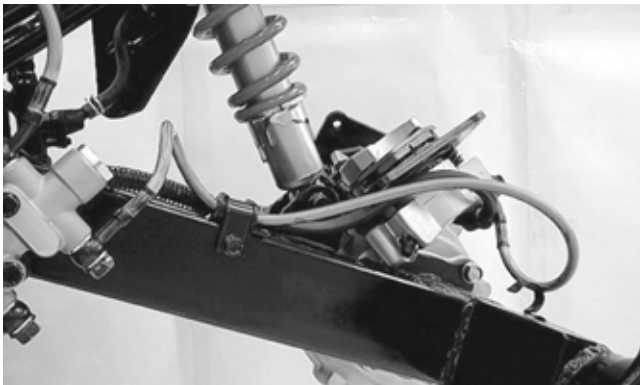

KM505

5. Remove the rear drive gear case; then drain the gear case.

6. Loosen the clamp securing the joint boot to the swing arm; then slip the boot off the swing arm.



KM504

7. Remove the clamp securing the brakeline hose to the swing arm; then remove the lower rear shock absorber mounting nut and bolt.

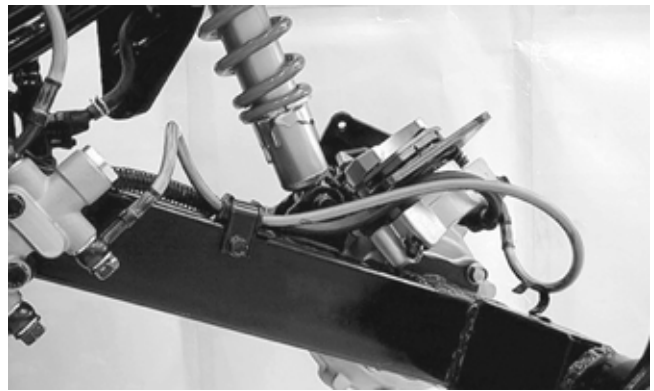

KM505

8. Remove the left and right pivot caps; then remove the right-side pivot bolt.

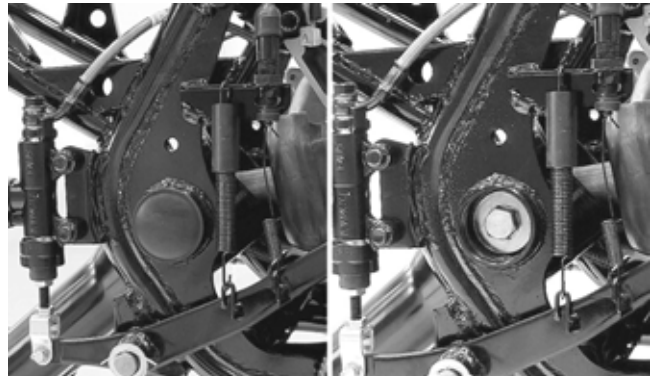

KM506

9. From the left side, remove the pivot lock nut using Pivot Lock Nut Wrench; then remove the left pivot adjusting bolt.

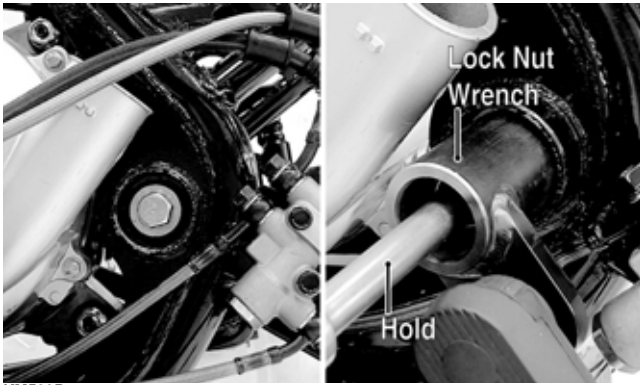

KM533B

10. Remove the swing arm assembly. Account for the driveshaft spring.

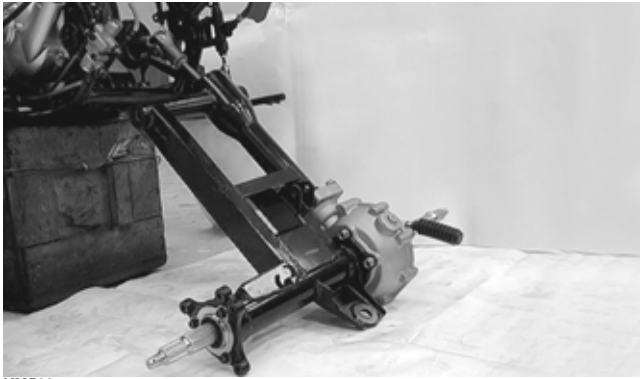

KM508

11. Disengage the universal joint from the transmission output shaft splines and set the driveshaft aside.



KM509

12. Remove the eight cap screws securing the swing arm to the final drive gear case.

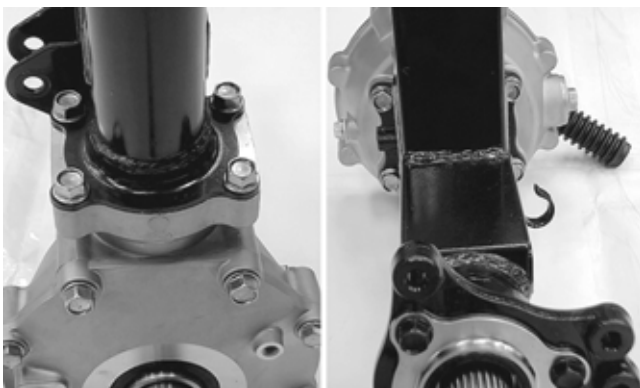

KM513

13. Support the swing arm from the right side; then using a rubber mallet, drive the axle shaft from the swing arm tube. Account for two O-rings.



KM536



KM537

14. Place the right end (shorter length) of the axle on a wood block; then using a rubber mallet, drive the gear case from the axle.

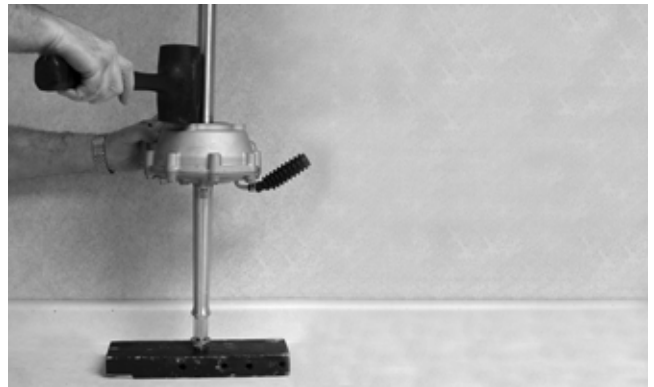

KM538

CAUTION

Support the gear case by hand or damage to the gear case could occur as it will fall free once it clears the splined portion of the axle.

CLEANING AND INSPECTING

1. Clean all parts with parts-cleaning solvent and dry with compressed air.
2. Inspect all seals for nicks, tears, or deterioration.



KM519



3. Inspect all splines and hubs for excessive wear, chips, cracks, or distortion.

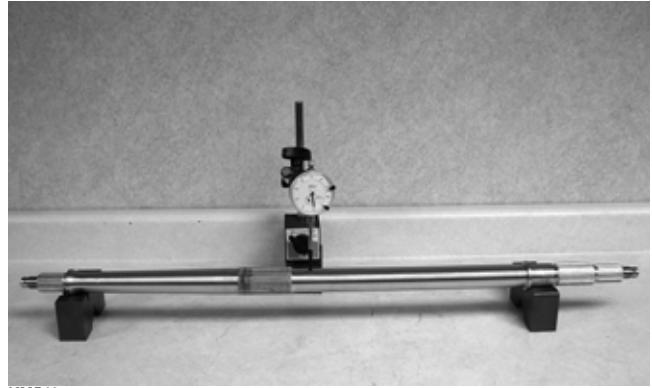

KM543

7. Check the final drive gear case assembly for smooth gear operation. If gears are noisy or if there is any catching or binding, the gear case assembly must be repaired.

DISASSEMBLING

1. Remove the cap screws securing the gear case cover to the gear case; then remove the gear case cover and right ring gear shim.

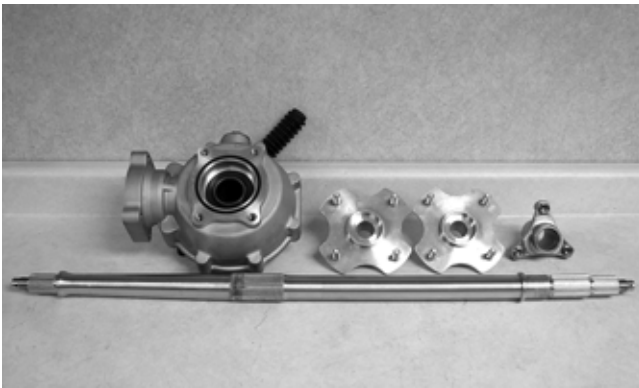

KM539



KM918



KM540

4. Check that all bearings turn freely and smoothly and are not worn, discolored, or missing dust seals.
5. Inspect brake components for leaks, excessive wear, or discoloration.
6. Check the axle shaft for runout using a dial indicator and suitable supports. Maximum runout is 3 mm (0.12 in).

■NOTE: Axle runout is equal to 1/2 the total dial indicator reading.

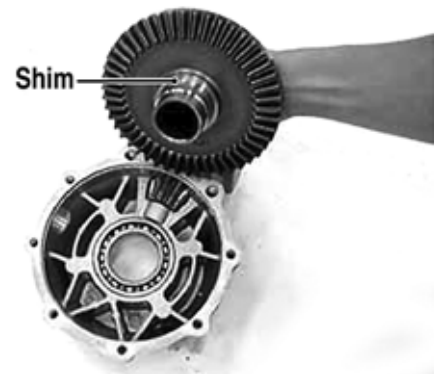

KM919A

2. Remove the oil seal from the front of the gear case; then using the Pinion Gear Bearing Nut Wrench, remove the pinion nut.

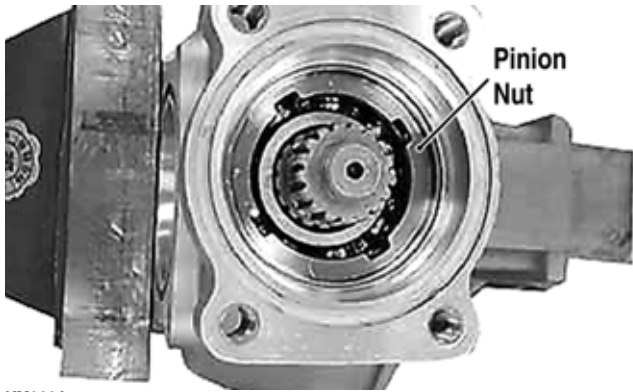

KM920A



KM924A

4. Remove the oil seals from the case and cover; then drive the bearings out of the case.



KM921

3. Remove the pinion shaft using the pinion puller; then using a three-jaw puller, remove the pinion bearing. Account for the pinion shim.



KM925



KM922



KM926

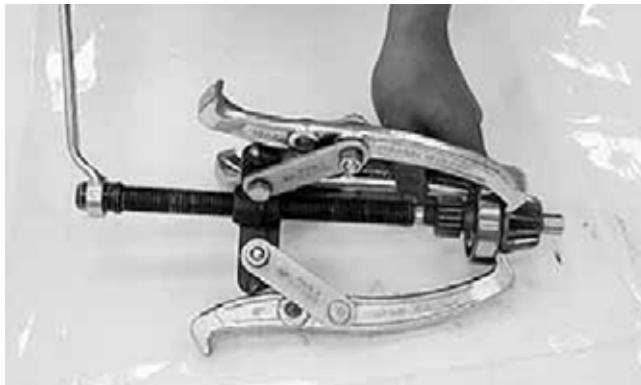

KM923

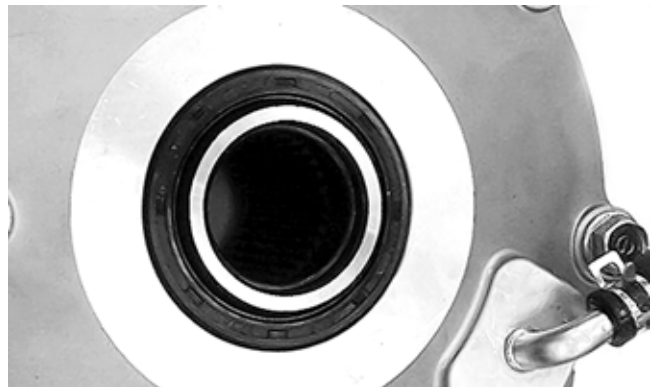

KM927



KM928

5. Heat the gear case to approximately 180° F and using a blind-bushing puller, remove the pinion needle bearing.

CLEANING AND INSPECTING

1. Clean all components in parts cleaning solvent and dry with compressed air.
2. Inspect all bearings for excessive wear, discoloration, roughness in turning, or flaking.
3. Inspect gears for excessive wear, chipped teeth, flaking, or discoloration.
4. Inspect the gear case and cover for cracks, warpage, or scoring of bearing bores.
5. If seals have not been removed and will be reused, inspect for nicks, tears, missing tension springs, or excessive wear on lips.

ASSEMBLING

1. Drive the bearings into the gear case and gear case cover using an appropriate bearing driver. Make sure the bearing is firmly seated.



KM926

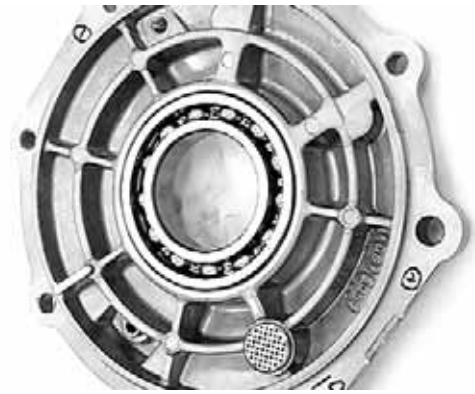

KM928

2. Apply grease to the seal lips; then using a seal driver, drive the seals into the gear case and cover (flat side out) until flush with the seal bore.

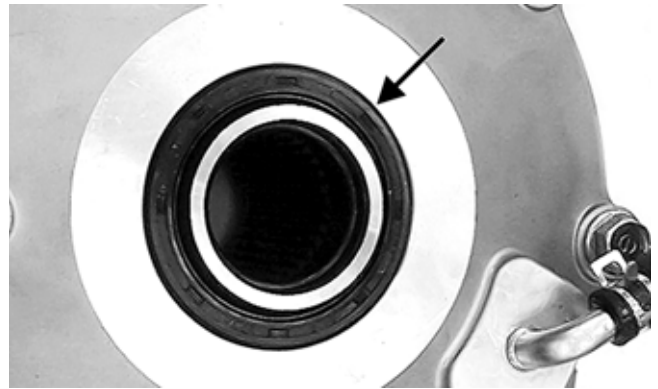

KM927A



KM925A

3. Drive a new pinion needle bearing into the gear case; then apply molybdenum disulfide grease to the needle bearing. Secure with the snap ring.
4. If the pinion bearing was removed from the pinion, install the shim and bearing on the pinion shaft with the marked-side of the bearing directed toward the front of the pinion shaft.



KM924



KM935

■NOTE: When the gear set, ring gear, ring gear bearing, and/or gear case is being replaced, use a 2 mm (0.08 in) thick shim for initial set-up.

5. Drive the pinion assembly into the gear case seating the bearing firmly; then secure with a new lock nut and using the pinion lock nut wrench, tighten to 72 ft-lb (97.9 N-m).

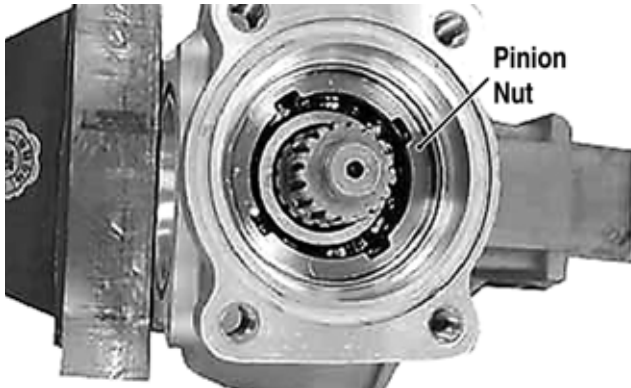

KM920A



KM921

6. Apply grease to the pinion seal lips and install into the gear case until fully seated; then apply a light coating of machinist's layout dye or paste to several ring gear teeth.
7. Install the proper shims on the ring gear and install into the gear case; then install the case cover and secure with the case cap screws. Tighten in a criss-cross pattern while rotating the pinion gear.

Checking Tooth Contact

1. Rotate the ring gear several turns in either direction; then check gear contact through the oil filler hole.
2. Examine the tooth contact pattern in the dye and compare the pattern to the illustrations.

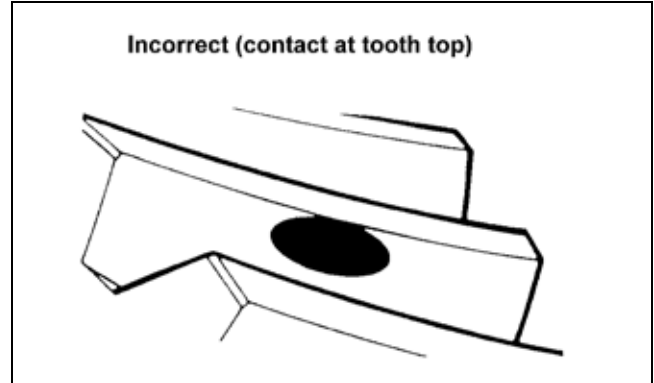

ATV-0103

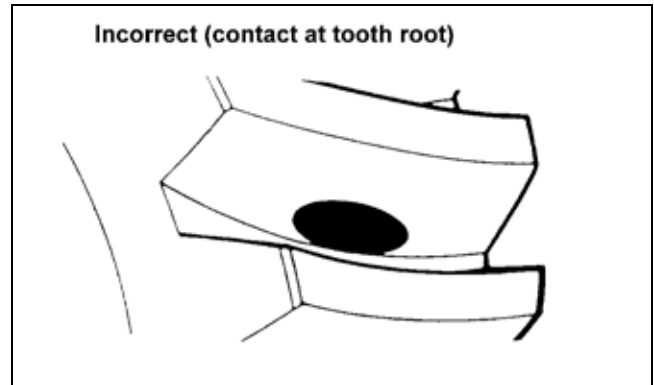

ATV-0105

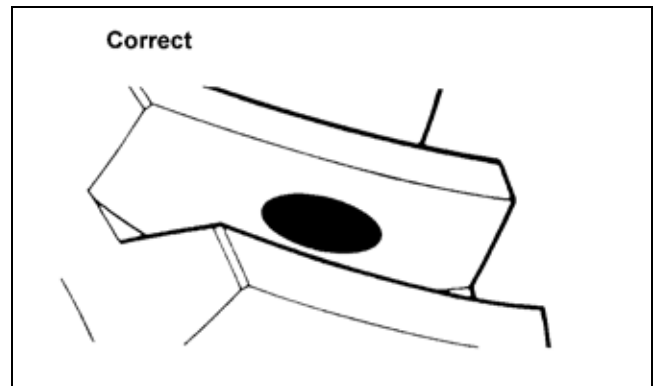

ATV-0104

Correcting Tooth Contact

■NOTE: If tooth contact pattern is comparable to the correct pattern illustration, no correction is necessary.

If tooth contact pattern is comparable to an incorrect pattern, correct tooth contact according to the following chart.

Tooth Contact	Shim Correction
Contacts at Top	Decrease Shim Thickness
Contacts at Root	Increase Shim Thickness

After tooth contact is corrected, gear backlash must be checked.

Checking Backlash

1. Mount a dial indicator through the oil fill plug to contact a tooth on the ring gear; then “zero” the dial indicator.

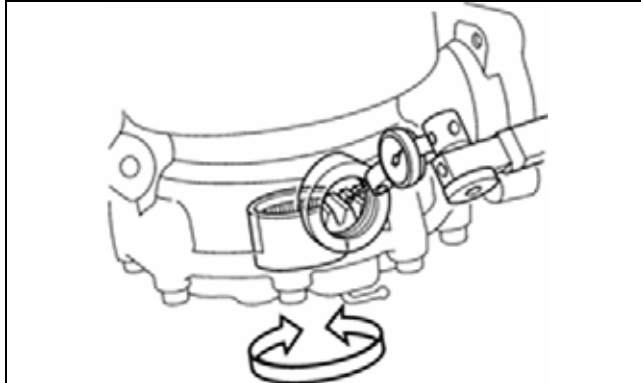

KM936

2. While locking the pinion shaft to prevent it from turning, rock the ring gear back and forth and record the measurement. Standard backlash should be 0.05-0.25 mm (0.002-0.010 in). Maximum service limit is 0.4 mm (0.016 in).
3. Remove the dial indicator and rotate the ring gear 120°; then repeat steps 1-2.
4. Repeat step 3 for a total of three measurements; then compare the difference between the three. Maximum allowable difference is 0.2 mm (0.08 in).

■NOTE: If the difference in measurements exceeds specifications, the bearings are not installed squarely or the gear case is warped. If backlash is not within specifications, correct using the following chart.

Backlash	Ring Gear Left Side	Ring Gear Right Side
Insufficient	Decrease Shim	Increase Shim
Excessive	Increase Shim	Decrease Shim

■NOTE: Always change both shims by the same amount on opposite sides. If left shim is increased, right shim must be decreased by the same amount.

5. After backlash is corrected, recheck gear tooth contact. Repeat Correcting Tooth Contact and Checking Backlash until both are within specifications.
6. When tooth contact and backlash are within specification, remove the cap screws securing the cover to the gear case.
7. Clean any oil from the mating surfaces; then apply an even coat of silicone sealant to the mating surfaces and install the gear case covers.

8. Install six 8 mm and two 10 mm cap screws and while rotating the pinion gear, tighten in a crisscross pattern to the specified torque (8 mm cap screws to 19 ft-lb [25.8 N-m], 10 mm cap screws to 36 ft-lb [49 N-m]).

REPLACING SWING ARM SEALS AND BEARINGS

To replace damaged or worn seals and bearings in the swing arm assembly, use the following procedure:

1. Remove the dust seals from the swing arm pivot; then using a slide hammer and bearing puller, remove the pivot bearings.

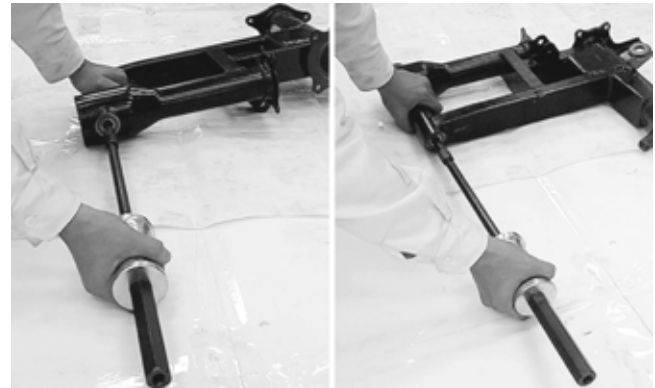

KM521

2. Drive in new pivot bearings until fully seated; then install new dust seals.



KM522

3. Remove the three cap screws, the dust plate, and one O-ring from the left axle housing on the swing arm; then from the right side, drive out the axle bearing.



KM523A

4. Using a suitable bearing driver, install the new axle bearing into the axle housing; then install the O-ring and dust plate. Tighten the three cap screws securely.

INSTALLING

1. Install new O-rings in the grooves of the gear case; then grease the center splines of the axle and install in the gear case from the left side.

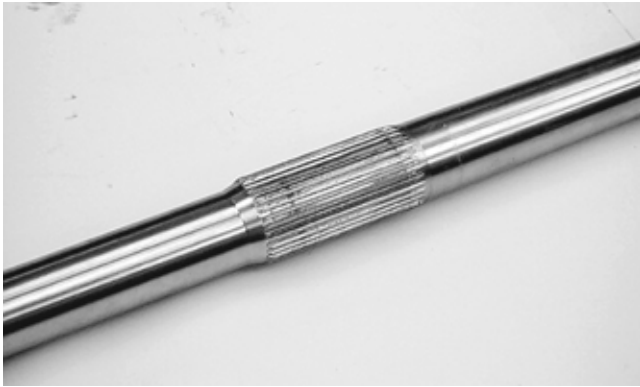

KM527

2. Install the rear axle and gear case into the right side of the swing arm; then secure the gear case to the swing arm assembly with the eight cap screws. Tighten to 50 ft-lb (68 N-m).

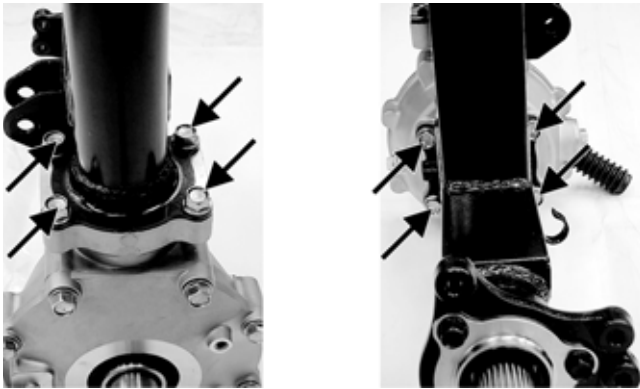

KM528A

3. Apply grease to the universal joint splines and driveshaft splines; then install the driveshaft spring into the driveshaft.

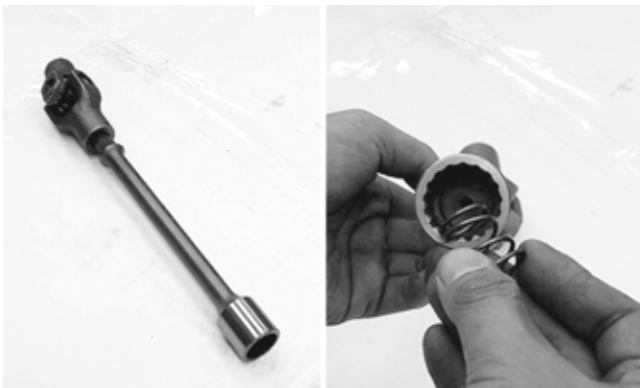

KM529

NOTE: Apply a liberal amount of grease to the driveshaft splines and the driveshaft spring. This will aid in keeping the spring in position while assembling.

4. Insert the driveshaft assembly into the swing arm tube; then engage the driveshaft splines with the pinion shaft splines in the rear drive gear case.

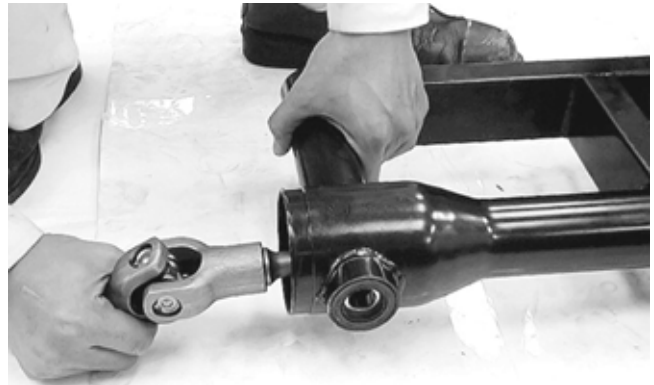

KM530

5. Pack approximately 3 g (0.1 oz) of grease into each swing arm pivot bearing cavity; then apply grease to the lips of the dust seals.



KM531

6. Align the swing arm assembly in the frame and engage the universal joint onto the splines of the secondary driven bevel gear shaft.



KM532

7. Install the right pivot bolt and left pivot adjusting bolt and tighten securely; then move the swing arm up and down to seat the bearings. Tighten the left pivot bolt to 36 in-lb (4 N-m) and the right pivot bolt to 82 ft-lb (111.5 N-m).
8. Install the left pivot lock nut; then while holding the left pivot adjusting bolt, use Pivot Lock Nut Wrench to tighten the lock nut to 82 ft-lb (111.5 N-m).

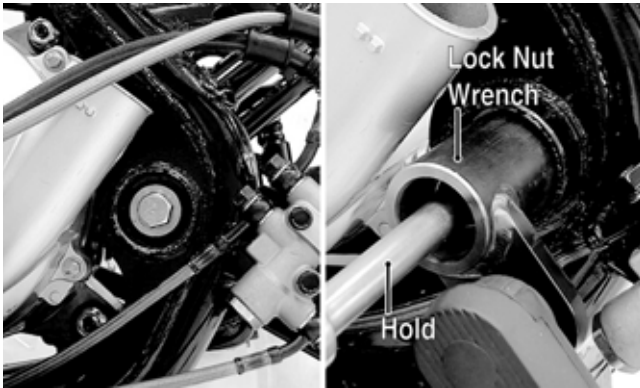

KM533B

- Install the shock absorber using the existing hardware and tighten to 29 ft-lb (39.4 N-m); then install the brakeline hose clamp on the swing arm and tighten securely.

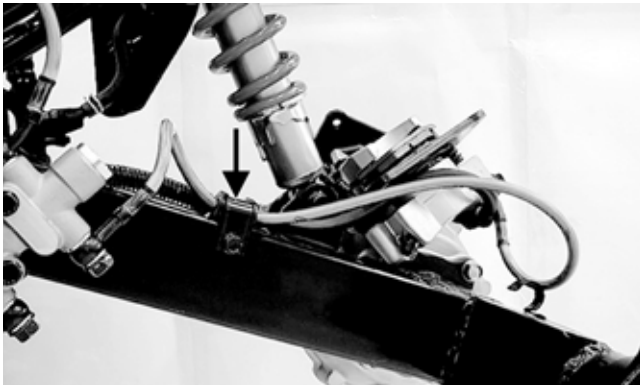

KM505A

- Tighten the final drive gear case drain plug securely; then remove the fill plug and level plug.

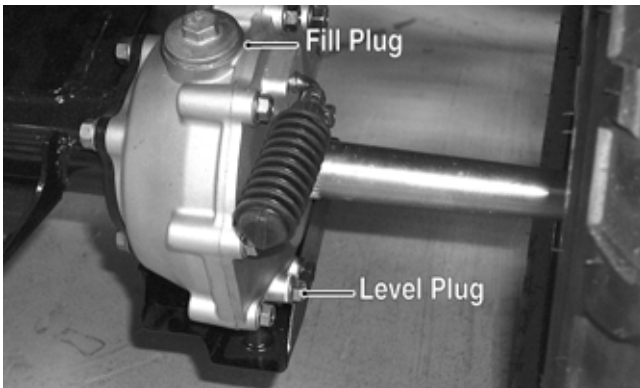

KM131A

- Pour the recommended gear lubricant into the fill hole until lubricant is visible on the threads of the level hole; then install the level plug and the fill plug and tighten securely.
- Install the rear drive gear case guard and tighten the cap screws securely.
- Apply grease to the brake disc hub and wheel hubs; then install the disc and rear hubs.

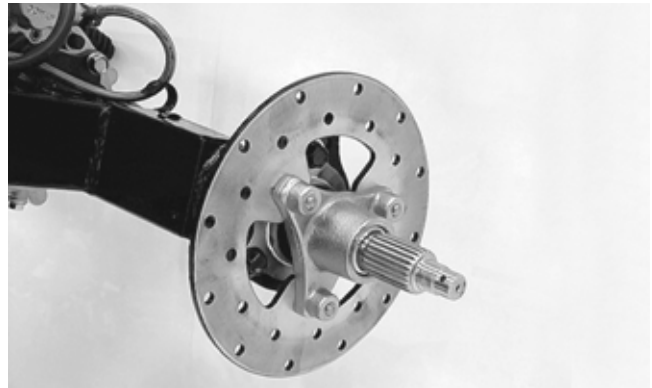

KM502

- Install the hub nuts and tighten to 72 ft-lb (97.9 N-m); then install new cotter pins and bend as shown.

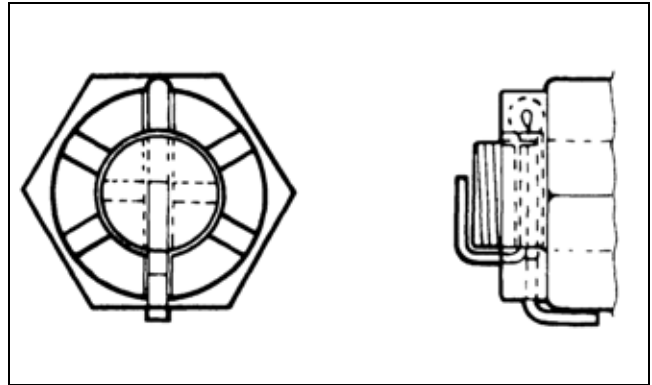

KM469

- Install the rear brake calipers and tighten to 25 ft-lb (34 N-m).
- Install the rear hub caps; then install the rear wheels and tighten in a crisscross pattern to 40 ft-lb (54.4 N-m).
- Remove the ATV from the support stand.

Front Brake Lever/Master Cylinder Assembly

■NOTE: The master cylinder is only serviceable as an assembly.

REMOVING

- Connect a clear hose to the bleed screw on either front brake caliper; then open the bleed screw and pump the brake fluid into a suitable container. Close the bleed screw.

CAUTION

Brake fluid is highly corrosive. Do not spill brake fluid on any surface of the ATV.

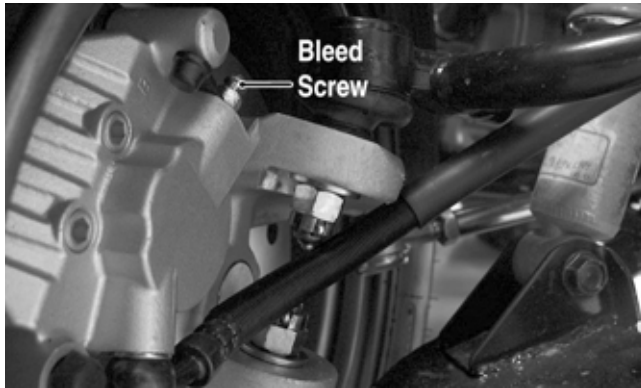

KM116A

■NOTE: Do not reuse brake fluid. When exposed to air, brake fluid rapidly absorbs moisture.

2. Remove the brakeline hose union bolt; then remove the cap screws securing the master cylinder assembly to the handlebar. Discard the crush washers from the union bolt.



KM800A

3. Remove the brake lever, brake light switch, and brake lever lock.
4. Remove the brake master cylinder by removing the two bolts securing it to the handlebar.

INSPECTING

1. Inspect the pivot bolt securing the brake lever for wear.
2. Inspect the brake lever for elongation of the pivot hole.
3. Inspect the reservoir for cracks and leakage.
4. Inspect the brake hose for cracks and deterioration and the condition of the fittings (threaded and compression).
5. Inspect the brake light switch for corrosion, cracks, missing or broken mounting tabs, or broken and frayed wiring.

■NOTE: If the brake light switch is defective, see **Electrical System — Lights**.

INSTALLING

1. Install the brake light switch on the master cylinder; then install the brake lever and brake lever lock.

2. Install the master cylinder assembly on the handlebar engaging the alignment stud in the hole in the handlebar; then secure with the master cylinder clamp and two cap screws. Make sure the UP arrow on the clamp is directed upward.



KM800C

3. Tighten the cap screws to 13 ft-lb (17.7 N-m).
4. Using new crush washers, secure the brake hose to the master cylinder with the brake hose union bolt. Tighten to 25 ft-lb (34 N-m).



KM800A

5. Fill the master cylinder with DOT 4 brake fluid; then bleed the system (see **Periodic Maintenance/Tune-Up — Hydraulic Brake Systems**).

Auxiliary Brake Pedal/Master Cylinder Assembly

■NOTE: The auxiliary brake master cylinder is only serviceable as an assembly.

REMOVING

1. Connect a clear plastic hose to the appropriate bleed screw on the rear brake caliper; then loosen the bleed screw and pump the foot brake until the fluid is pumped into a suitable container.

CAUTION

Brake fluid is highly corrosive. Do not spill brake fluid on any surface of the ATV.

2. Compress the reservoir clamp and remove the reservoir hose; then remove the union bolt. Account for and discard two crush washers.

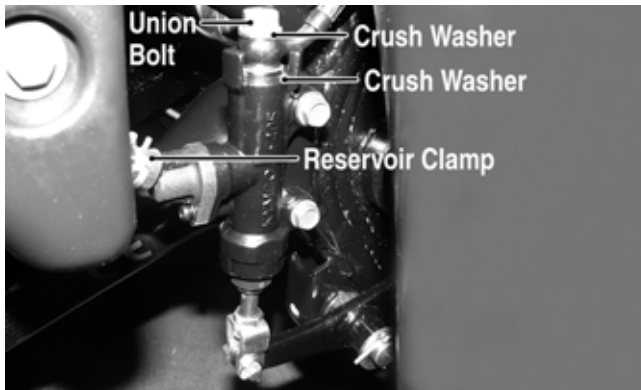

KM801A

3. Remove the cotter pin from the clevis pin and remove the clevis pin; then remove the two cap screws securing the master cylinder to the frame and remove the master cylinder.

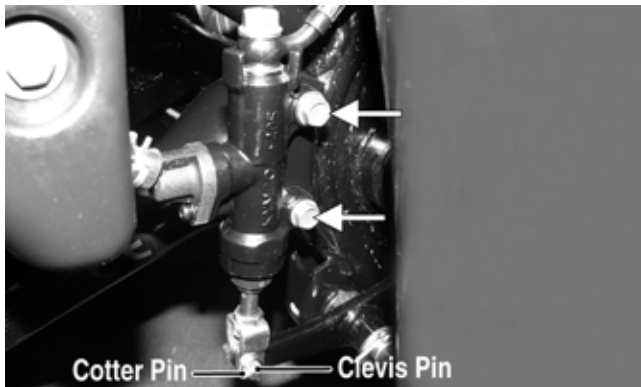

KM801B

4. Loosen the jam nut; then remove the clevis and adjuster nut.

INSTALLING

1. Install the jam nut; then install the clevis and adjuster nut. Finger-tighten only at this time.
2. Secure the master cylinder to the frame with the two cap screws and tighten securely.
3. Using two new crush washers, connect the brake hose to the master cylinder with the union bolt; then making sure the spring clamp is seated securely, connect the reservoir hose to the master cylinder. Tighten the union bolt to 25 ft-lb (34 N-m).

4. Making sure the brake pedal is fully released and against the stop, turn the clevis and adjuster nut until the hole in the clevis is aligned with the hole in the brake pedal lever; then tighten the jam nut securely.

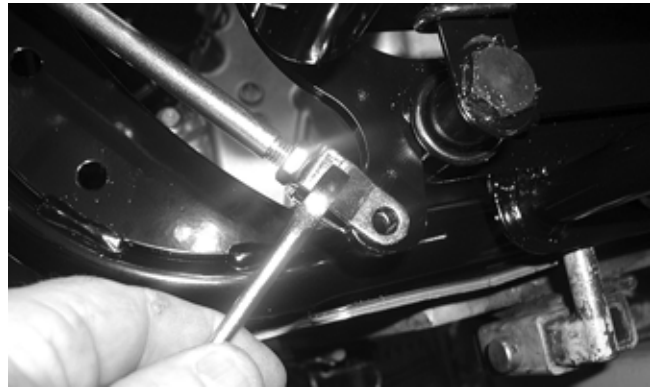

CD476

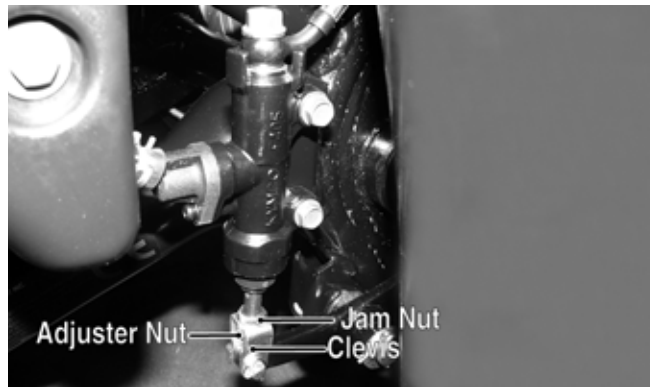

KM801C

5. Fill the master cylinder reservoir with DOT 4 brake fluid and bleed the system (see Periodic Maintenance/Tune-Up — Hydraulic Brake Systems).

Troubleshooting Drive System

Problem: Power not transmitted from engine to wheels

Condition	Remedy
1. Rear axle shaft serration worn — broken	1. Replace shaft

Troubleshooting Brake System

Problem: Braking poor

Condition	Remedy
1. Pad worn 2. Pedal free-play excessive 3. Brake fluid leaking 4. Hydraulic system entrapped air 5. Master cylinder/brake cylinder seal worn	1. Replace pads 2. Adjust free-play 3. Repair — replace hydraulic system 4. Bleed hydraulic system 5. Replace appropriate cylinder

Problem: Brake lever travel excessive

Condition	Remedy
1. Hydraulic system entrapped air 2. Brake fluid low 3. Brake fluid incorrect 4. Piston seal — cup worn	1. Bleed hydraulic system 2. Add fluid to proper level/bleed system 3. Replace with correct fluid 4. Replace master cylinder

Problem: Brake fluid leaking

Condition	Remedy
1. Connection joints loose 2. Hose cracked 3. Piston seal worn	1. Tighten joint 2. Replace hose 3. Replace master/brake cylinder

Suspension

The following suspension system components should be inspected periodically to ensure proper operation:

- A. Shock absorber rods not bent, pitted, or damaged.
- B. Rubber damper not cracked, broken, or missing.
- C. Shock absorber body not damaged, punctured, or leaking.
- D. Shock absorber eyelets not broken, bent, or cracked.
- E. Shock absorber eyelet bushings not worn, deteriorated, cracked, or missing.
- F. Shock absorber spring not broken or sagging.

Front Shock Absorbers

REMOVING

1. Secure the ATV on a support stand to elevate the wheels and to release load on the suspension.

⚠ WARNING

Make sure the ATV is solidly supported on the support stand to avoid injury.

2. Remove the cap screws and nuts securing each shock absorber to the A-arm and frame.



CLEANING AND INSPECTING

1. Clean the shock absorbers in parts-cleaning solvent.
2. Inspect each shock rod for nicks, pits, bends, and oily residue.
3. Inspect the springs, spring retainers, shock rods, shock bodies, and eyelets for cracks, leaks, and bends.

INSTALLING

1. Install each shock absorber to the frame and A-arm with cap screws and nuts. Tighten all nuts to 29 ft-lb (39.4 N-m).

CAUTION

Do not tighten the nut beyond the recommended specification or the shock eyelet or mount WILL be damaged.

2. Remove the ATV from the support stand.

Rear Shock Absorber

REMOVING

1. Secure the ATV on a support stand to elevate the wheels and to release load on the suspension.

⚠ WARNING

Make sure the ATV is solidly supported on the support stand to avoid injury.

2. Remove the lower shock mounting nut and cap screw.

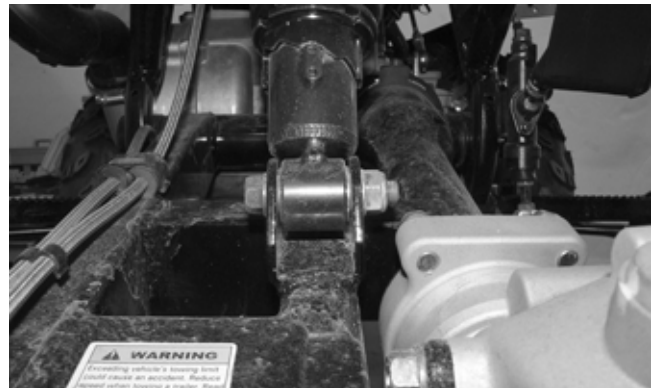

■NOTE: Support the swing arm with a block of wood or other support to allow removal of the cap screw.

3. Remove the upper shock mounting nut and cap screw; then remove the shock absorber from the frame.

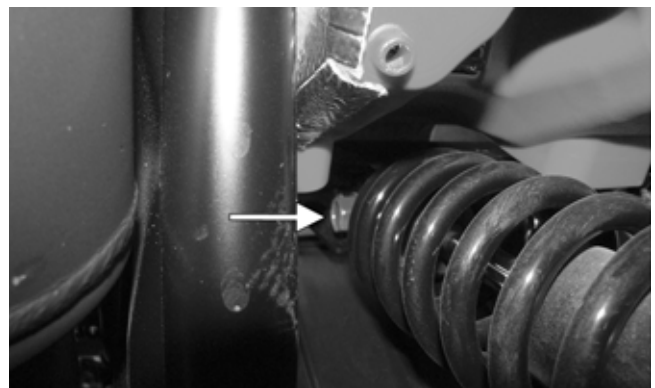

CLEANING AND INSPECTING

1. Clean the shock absorber in parts-cleaning solvent.

2. Inspect the shock absorber body, bottom stop, and rubber bushing for damage and leaking oil. If any defects are found, replace the shock absorber.
3. Inspect the spring, spring seat, and preload adjustment collar for damage or corrosion. If corrosion or damage is present on the collar, it must be replaced.

INSTALLING

1. Raise the swing-arm and place the shock absorber in position; then install the upper and lower cap screws and nuts.
2. Tighten the upper nut and the lower nut to 29 ft-lb (39.4 N-m).

ADJUSTING SPRING PRELOAD

The rear spring preload is adjustable by changing the spring set length via the ramped adjustment collar. Using the following procedure, adjust the spring:

Adjust the spring preload by turning the adjuster collar (A) clockwise (when viewed from above the shock) to increase spring preload or counterclockwise to decrease spring preload.



XA090A

■NOTE: To aid in adjusting preload, safely lift the vehicle using a jack from under the frame. Lift the vehicle high enough so the wheels are no longer touching the floor.

Front A-Arms

REMOVING

1. Secure the ATV on a support stand to elevate the front wheels; then remove a front wheel.

WARNING

Make sure the ATV is solidly supported on the support stand to avoid injury.

2. Remove the hub cap; then remove the cotter pin from the nut.

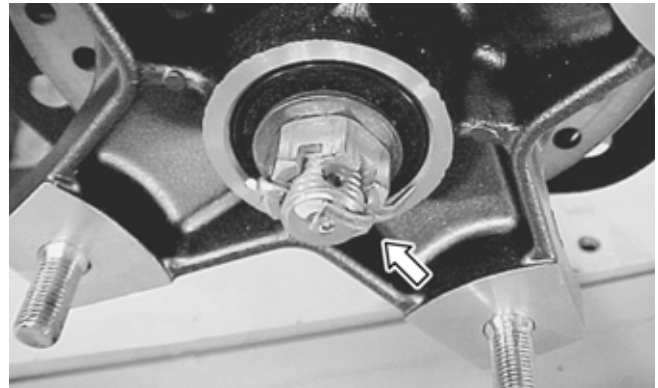

SP366

3. Remove the nut securing the hub.
4. Remove the cap screws securing the brake caliper; then remove the caliper and lay aside.

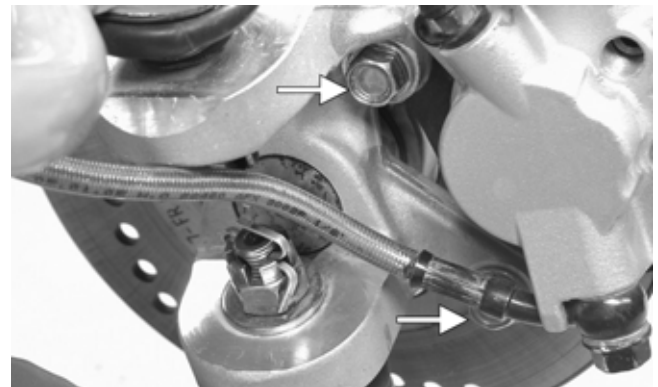

KM266A

5. Remove the hub assembly; then remove the disc cover.



KM569

6. Remove the cotter pin and slotted nut securing the tie rod end to the knuckle; then remove the tie rod end from the knuckle.



KM573

7. Remove the brake hose clamp from the A-arm; then remove the cotter pins and slotted nuts securing the upper and lower ball joints.

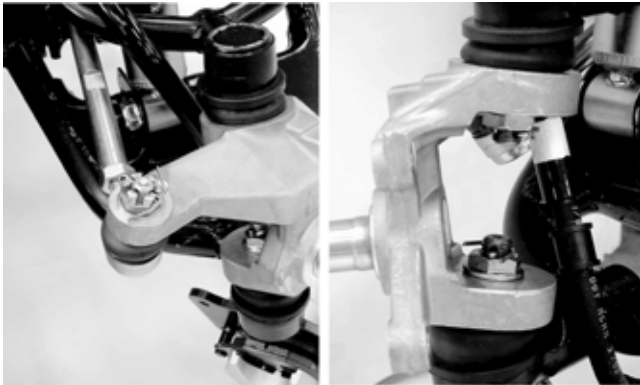

KM570

8. Remove the shock absorber mounting cap screws; then remove the shock absorber assembly.
9. Using a ball joint remover, remove the ball joints from the knuckle; then remove the front bumper.

CLEANING AND INSPECTING

1. Clean the knuckle in parts-cleaning solvent; then dry with compressed air. If any damage or excessive wear is detected, the knuckle must be replaced.
2. Inspect the ball joint for boot damage or wear. Replace the A-arm if the ball joint is damaged or worn.
3. Inspect the arm for broken welds, cracks, or bends. Replace if damaged.
4. Remove the bushings and dust seals and inspect for damage to seal lips and spacers.

■NOTE: The pivots are equipped with roller bearings. The bearing rollers may fall out when the spacers are removed.

5. Check the bearings for excessive wear and replace them if worn.
6. Using a suitable bearing remover, remove the pivot bearings; then clean all parts in parts-cleaning solvent.

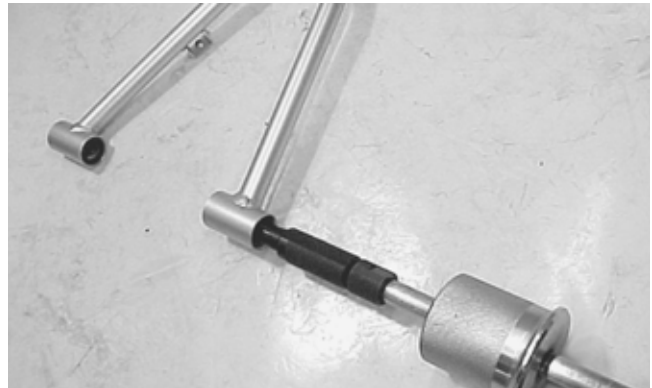

SP382

■NOTE: All bearings, bushings, and seals that are removed must be replaced with new ones.

INSTALLING

1. Install the bearings in the upper arm pivot to a depth of 13.6 mm (0.535 in) with a bearing installer and suitable spacer.

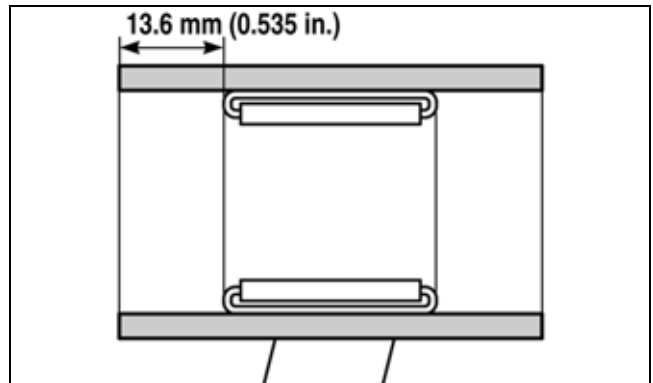

ATV2196A

2. Coat the spacers and the lips of the dust seals with multi-purpose grease; then install them in the upper pivot.
3. Repeat steps 1 and 2 for the lower A-arm.
4. Clean all grease from the ball joint tapers and the knuckle bores; then install the arms to the steering knuckle and tighten the ball joint nuts to 22 ft-lb (29.9 N-m). Install new cotter pins.

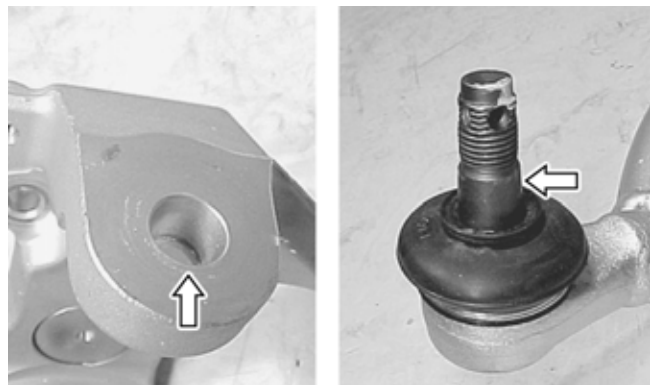

SP388A

■NOTE: During assembly, new cotter pins should be installed.

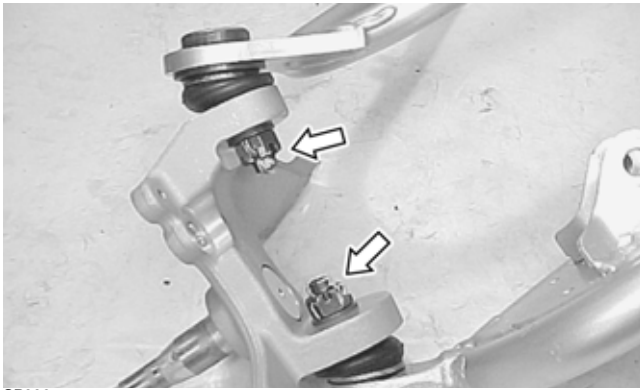

SP390

5. Install the arms to the frame with the pivot cap screws; then tighten the nuts to 32 ft-lb (43.5 N-m).



KM579

6. Install the front bumper assembly; then install the front shock absorbers. Apply red Loctite #271 on the cap screw threads and tighten to 29 ft-lb (39.4 N-m).
7. Apply red Loctite #271 to the mounting cap screws; then install the disc cover and tighten securely.



KM569

8. Connect the tie rod ends to the steering knuckle; then tighten the nut to 15 ft-lb (20.4 N-m) and install a new cotter pin.

■NOTE: During assembly, new cotter pins should be installed.



KM581

Wheels and Tires

TIRE SIZE

⚠ WARNING

Use only approved tires when replacing tires. Failure to do so could result in unstable ATV operation.

The ATV is equipped with low-pressure tubeless tires of the size and type listed. Do not under any circumstances substitute tires of a different type or size.

⚠ WARNING

Always use the size and type of tires specified. Always maintain proper tire inflation pressure.

⚠ WARNING

Do not mix tire tread patterns. Use the same pattern type on front and rear. Failure to heed warning could cause poor handling qualities of the ATV and could cause excessive drivetrain damage not covered by warranty.

TIRE INFLATION PRESSURE

Tire inflation pressure should be as specified.

REMOVING

1. Secure the ATV on a support stand to elevate the wheels.

⚠ WARNING

Make sure the ATV is solidly supported on the support stand to avoid injury.

2. Remove the wheels.

■NOTE: Keep left-side and right-side wheels separated for installing them on their proper sides.

CLEANING AND INSPECTING

1. Clean the wheels and hubs with parts-cleaning solvent.
2. Clean the tires with soap and water.
3. Inspect each wheel for cracks, dents, or bends.
4. Inspect each tire for cuts, wear, missing lugs, and leaks.

INSTALLING

1. Install each wheel on its hub.

■NOTE: Make sure each wheel is installed on its proper hub as noted in removing (the “rotation arrow” must indicate forward direction of rotation).



XA091

2. Tighten in a crisscross pattern to 40 ft-lb (54.4 N-m).

CHECKING/INFLATING

1. Using an air pressure gauge, measure the air pressure in each tire. Adjust the air pressure as necessary to meet the recommended inflation pressure.

2. Inspect the tires for damage, wear, or punctures.

⚠ WARNING

Do not operate the ATV if tire damage exists.

■NOTE: If repair is needed, follow the instructions found on the tire repair kit or remove the wheel and have it repaired professionally.

■NOTE: Make sure all tires are the specified size and have identical tread pattern.

3. Check the front wheel toe-in and toe-out and adjust as necessary (see Steering/Body/Controls — Front Wheel Alignment).

4. Test drive the ATV on a dry, level surface and note any pulling to the left or right during acceleration, deceleration, and braking.

■NOTE: If pulling is noted, measure the circumference of the front and rear tires on the pulling side. Compare the measurements with the tires on the opposite side. If pulling is noted during braking only, check and adjust the brakes as necessary and recheck operation (see Periodic Maintenance/Tune-Up — Hydraulic Brake Systems).

5. Increase the air pressure in the tires with the smallest circumference measurement until all tires are equal in circumference.

6. Repeat steps 4-5 as necessary to ensure proper handling.

Troubleshooting

Problem: Suspension too soft	
Condition	Remedy
<ol style="list-style-type: none"> 1. Spring(s) weak 2. Shock absorber damaged 	<ol style="list-style-type: none"> 1. Replace spring(s) 2. Replace shock absorber
Problem: Suspension too stiff	
Condition	Remedy
<ol style="list-style-type: none"> 1. A-arm-related bushings worn or binding 	<ol style="list-style-type: none"> 1. Replace bushing
Problem: Suspension noisy	
Condition	Remedy
<ol style="list-style-type: none"> 1. Cap screws (suspension system) loose 2. A-arm-related bushings worn 	<ol style="list-style-type: none"> 1. Tighten cap screws to specified torque 2. Replace bushings
Problem: Rear wheel oscillation	
Condition	Remedy
<ol style="list-style-type: none"> 1. Rear wheel hub bearings worn — loose 2. Tires defective — incorrect 3. Wheel rim distorted 4. Wheel hub cap screws loose 5. Axle shaft nut loose 6. Auxiliary brake adjusted incorrectly 7. Rear suspension arm-related bushing worn 8. Rear shock absorber damaged 9. Rear suspension arm nut loose 	<ol style="list-style-type: none"> 1. Replace bearings 2. Replace tires 3. Replace rim 4. Tighten cap screws to specified torque 5. Tighten nut 6. Adjust brake 7. Replace bushing 8. Replace shock absorber 9. Tighten nut

TRACKER
OFF ROADTM

©2024 TRACKER OFF ROADTM
®TM Trademarks of White River Marine Group, LLC