



OWNER'S MANUAL

OX 400

 **WARNING**

Read and comply with all of the instructions and safety precautions in this manual and on all product labels.

Failure to follow the safety precautions could result in serious injury or death.

California Proposition 65



WARNING

The Engine Exhaust from this product contains chemicals known to the State of California to cause cancer, birth defects or other reproductive harm.

 **WARNING**

Never modify the vehicle in any way that will alter the weight distribution of the vehicle, decrease its stability or increase the speed beyond the factory specifications. Such modifications can cause serious personal injury or death. The manufacturer prohibits and disclaims responsibility for any such modifications or any other alteration which would adversely affect the safety of the vehicle.

OWNER'S MANUAL

GASOLINE

OX 400

MODEL YEAR 2020 - Current

MANUFACTURER INFORMATION

Textron Specialized Vehicles, Inc.

1451 Marvin Griffin Road

Augusta, Georgia, USA 30906-3852

877-294-6727

www.trackeroffroad.com

WELCOME

Thank you for purchasing this vehicle. Before driving your new vehicle, read this owner's manual to familiarize yourself with safe driving practices, operation, features and controls.

This manual contains instructions for minor maintenance only. Information about major repairs can be found in the repair manual. Your dealer has thorough knowledge of your vehicle and wants your total satisfaction with your purchase. We recommend you return to your dealership for all of your service needs during, and after the warranty period.

Repair or replacement parts can be purchased from your dealer or through the manufacturer's parts and accessories department.

These are original instructions as defined by 2006/42/EC.

The manufacturer maintains the right to change the design of the vehicle without responsibility to make the changes on units purchased before changes were made. The information in this manual can change without notice.

All information in this owner's manual is based on the latest product information at the time of publication. Due to constant improvements in the design and quality of production components, some discrepancies may be found between your vehicle and the information presented in this publication. The content in this publication is intended for reference use only. The manufacturer is not liable for omissions or inaccuracies. Any reprinting or reuse of the content in this publication, whether whole or in part, is expressly prohibited.

Printed in USA

INTRODUCTION

MANUFACTURER'S INTENDED USE7
 WARRANTY AND REGISTRATION7
 EXHAUST EMISSIONS7
 BATTERY PROLONGED STORAGE8
 BATTERY DISPOSAL8
 REPAIR AND PARTS MANUALS8

SAFETY LABELS

SAFETY LABELS9
 Operation (P/N 699801)9
 Engine Warning (P/N 74093G01)9
 Governor Warning (P/N 608527)10
 Bed Latch Warning (P/N 74099G01)10
 Bed Load (P/N 74821G01)10
 Pinch Warning (P/N 651671)10
 Patent Label (P/N 10005569)10

SAFETY

MAXIMUM CARGO LOAD / MAXIMUM WEIGHT CAPACITY11
 TIRE PRESSURE11
 OPERATOR SAFETY11
 Unauthorized Operation12
 Operating without Instruction12
 Alcohol or Drugs12
 Passenger13
 Before Operating13
 Load Operation13
 Fuel Handling Guidelines13
 Carbon Monoxide Exposure13
 Driving in Reverse13
 Driving a Damaged Vehicle14
 Driving at Maximum Speeds14
 Driving on Pavement14
 Driving on Public Roads14
 Spark Arrestor and Use on Public Lands14
 Turning14
 Driving Uphill14
 Driving Downhill14
 Stalling on a Hill14
 Tires14
 Slippery Terrain14
 HOT EXHAUST SYSTEMS14
 VEHICLE LIFTING15
 VEHICLE MODIFICATION15
 MAINTENANCE SAFETY15

TABLE OF CONTENTS

FEATURES AND CONTROLS

KEY SWITCH	17
HEADLIGHT SWITCH	17
FUEL GAUGE WITH LOW OIL PRESSURE INDICATOR	17
CUP HOLDER	17
12V OUTLET	17
WINCH REMOTE SOCKET (IF EQUIPPED)	17
WINCH SWITCH (IF EQUIPPED)	17
STEERING WHEEL	18
BRAKE PEDALS	18
Brake Pedal	18
Parking Brake Pedal	18
ACCELERATOR PEDAL	18
DIRECTION SELECTOR	18
CHOKE	18
EFI MALFUNCTION INDICATOR LIGHT (MIL)	19
SEAT BOTTOM	19
GLOVE BOX / STORAGE COMPARTMENTS	19
FUEL TANK CAP	19
CANOPY TOP AND WINDSHIELD	19
TRUCK BED	20
Manual Bed Release Lever	20

OPERATION

SAFETY	21
BEFORE INITIAL USE	21
PRE-RIDE INSPECTION	21
ENGINE BREAK-IN	22
CVT BELT BREAK-IN	22
FUEL	22
STARTING AND STOPPING THE ENGINE	23
Starting on a Hill	23
ACCELERATING	23
BRAKING	24
DRIVING PROCEDURE	24
Coasting	24
DRIVING WITH A PASSENGER	24
SLIPPERY SURFACES	24
DRIVING UPHILL	25
TRAVERSING HILLSIDES	25
DRIVING DOWNHILL	25
STALLING ON A HILL	25
DRIVING IN REVERSE	26
PARKING THE VEHICLE	26
BATTERY	26
HAULING CARGO	26
Maximum Cargo Load / Maximum Weight Capacity	27

TRUCK BED OPERATION	28
Load Bed (P/N 74821G01)	28
DUMPING THE TRUCK BED	28
TOWING	29
WINCH	
WINCH SAFETY	31
WINCH OPERATION	32
WINCH CABLE CARE	34
SHOCK LOADING	34
WINCH MAINTENANCE SAFETY	34
VEHICLE MAINTENANCE	
MAINTENANCE SAFETY	35
SCHEDULED MAINTENANCE	35
Initial Service Requirements	35
Severe Use Conditions	35
SCHEDULED MAINTENANCE CHART	36
RECOMMENDED LUBRICANTS AND FLUIDS	38
REPLACEMENT OF MAINTENANCE ITEMS	38
LIFTING THE VEHICLE	39
Lifting Front	39
Lifting Rear	39
Lowering Vehicle	39
VEHICLE CLEANING AND CARE	40
Washing the Vehicle	40
Polishing the Vehicle	40
TIRES	40
Tire Pressure	41
Tire Repair	41
Tire Replacement	41
WHEELS	41
Wheel Removal	41
Wheel Installation	42
LIGHTS	42
Halogen Headlight Bulb Replacement	42
Taillight	43
FUSE REPLACEMENT	43
FOUR CYCLE ENGINE	43
Engine Specifications	43
CHECK THE OIL LEVEL	43
CHANGE THE ENGINE OIL	44
Remove the Engine Oil	44
Change the Oil Filter	45
Refill Oil	45
STARTER/GENERATOR BELT	46
Adjusting the Belt	46
AIR INTAKE AND COOLING FINS	46

TABLE OF CONTENTS

REAR AXLE	47
Checking the Axle Oil Level	47
AIR FILTER	47
SPARK PLUG	47
MALFUNCTION INDICATOR LIGHT (MIL)	48
BRAKES	50
Periodic Brake Test	50
BATTERY	51
Battery Cleaning	51
Battery Charging	51
Discharged Battery	52
Battery Disposal	52
Battery Storage	52
TRANSPORTING THE VEHICLE	52
Hauling the Vehicle	52
Towing the Vehicle	53
VEHICLE STORAGE	54
Remove from Storage	54
 SPECIFICATIONS	
OX 400 - VEHICLE SPECIFICATIONS	55

INTRODUCTION

The following symbols appear throughout this manual and on vehicle labels. Your safety is involved when these symbols are used. Become familiar with their meanings before reading the manual.



DANGER indicates a hazardous situation that, if not avoided, will result in death or serious injury.



WARNING indicates a hazardous situation that, if not avoided, could result in death or serious injury.



CAUTION indicates a hazardous situation that, if not avoided, could result in minor or moderate injury.



The **PROHIBITION SAFETY SIGN** indicates an action **NOT** to take in order to avoid a hazard.



The **MANDATORY ACTION SIGN** indicates an action that **NEEDS** to be taken to avoid a hazard.



Failure to comply with the warnings in this manual can result in severe injury or death.



Read this entire manual carefully before operating this vehicle. Do not attempt to operate this vehicle until you have thorough knowledge of the controls and features.



Regular inspections and maintenance, along with good operating techniques, will help ensure your safe enjoyment of the capabilities and reliability of this vehicle.

This vehicle was designed and manufactured in the United States of America (USA). The standards and specifications in the following information originate in the USA unless otherwise indicated.

When servicing engines, all adjustments and replacement components must be per the original vehicle specifications to maintain the USA Federal and State emission certification applicable at the time of manufacture.

MANUFACTURER'S INTENDED USE

This vehicle is designed and manufactured for off road use only. Use on public streets, roads, or highways is illegal in most areas and increases the risk of an accident involving other vehicles and people. This vehicle does not meet FMVSS (Federal Motor Vehicle Safety Standards) for public street, road, or highway use.

Check all laws and regulations before choosing an area to operate your vehicle.

WARRANTY AND REGISTRATION

A literature package is included with the purchase of a new vehicle. The package contains the following items:

- Vehicle Warranty Statement
- EPA and California Emission Control Warranty Statement (EVAP emission)
- Emission Control System Warranty Statement (Engine emission)
- Vehicle registration can be completed at www.trackeroffroad.com

Use Original Equipment Manufacturer (OEM) approved parts to keep the vehicle warranty effective.

Tampering with or adjusting the governor to allow the vehicle to operate above factory specifications will void the vehicle warranty.

All information, including coverage, limitations, exclusions and how to obtain warranty service is included in the literature package with the purchase of the vehicle. It can also be obtained from your dealer.

EXHAUST EMISSIONS

The exhaust emissions of this vehicle's engine complies with regulations set forth by the Environmental Protection Agency (EPA) of the United States of America (USA) at time of manufacture. Significant fines could result from modifications or tampering with the engine, fuel, ignition, or air intake systems. Refer to the warranty statements provided with the vehicle for all information.

INTRODUCTION

BATTERY PROLONGED STORAGE

Batteries discharge over time. The rate of discharge changes according to the ambient temperature, the age and condition of the batteries.

Completely charged batteries will not freeze in winter temperatures unless the temperature is less than -75°F (-60°C).

BATTERY DISPOSAL

Lead-acid batteries are recyclable. Return discarded batteries to distributor, manufacturer or lead smelter for recycling. For neutralized spills, put any residue in acid-resistant containers with absorbent material such as sand. Dispose in accordance with local, state and federal regulations for acid and lead compounds. Contact local or state environmental authorized people for the disposal information. Vehicle Identification Numbers

PART A

[]	
MODEL []	
DATE CODE []	
SERIAL No. []	
Bar Code []	GVW Lb / kg Lb / kg W Batt Nom Power Hp / kw

PART B

Rated Capacity W/Operator lb/kg /			
Lb/kg W/O Batt /		System voltage	V
Max Batt lb/kg /		Max Draw bar lb/kg /	
[]			

SERIAL No. []
Bar Code []

PART C and D

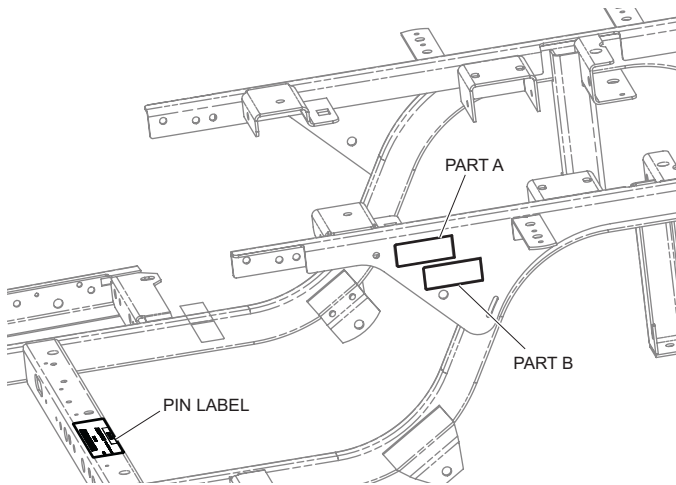

Record the vehicle identification numbers in the spaces provided below. These identification numbers is required when ordering parts from the manufacturer.

Vehicle Model Number: _____

Frame PIN: _____

REPAIR AND PARTS MANUALS

The following manuals can be purchased through your dealer:

- repair manual
- parts manual

SAFETY LABELS

SAFETY LABELS

Safety and warning labels are on the vehicle for your protection. Read carefully and comply with the instructions on the labels. If any label shown in this manual is different from the label on your vehicle, always follow the instructions on the vehicle label.

If a label comes off or becomes illegible, contact your dealer for a replacement. The part number is provided in this manual, printed on the label, or can be obtained from your dealer.

Operation (P/N 699801)

Located on the dash around the steering wheel.

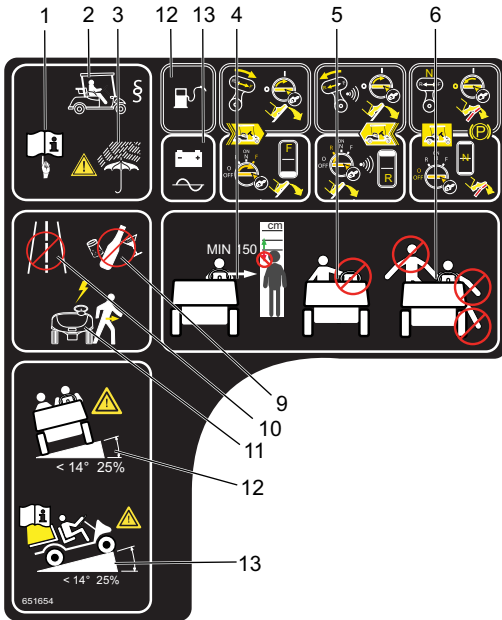

- 1 - READ THE MANUAL
- 2 - DRIVE IN ACCORDANCE WITH LOCAL LAWS AND REGULATIONS
- 3 - USE CAUTION IN BAD WEATHER
- 4 - MINIMUM HEIGHT REQUIRED TO DRIVE
- 5 - NO OPERATION FROM PASSENGER SEAT
- 6 - NO STANDING AND KEEP ENTIRE BODY INSIDE VEHICLE
- 7 - REFER TO OWNER'S MANUAL FOR CARGO INFORMATION
- 8 - MAXIMUM CROSS RAMP OR HILL
- 9 - NO OPERATION IF USING DRUGS OR ALCOHOL
- 10 - NO OPERATION ON PUBLIC ROADS
- 11 - EXIT VEHICLE WHEN LIGHTNING IS IN AREA
- 12 - DO NOT DRIVE THE VEHICLE ACROSS GRADES GREATER THAN 14° OR 25%
- 13 - DO NOT DRIVE THE VEHICLE UP GRADES GREATER THAN 14° OR 25%

Engine Warning (P/N 74093G01)

Located on the truck bed closeout.

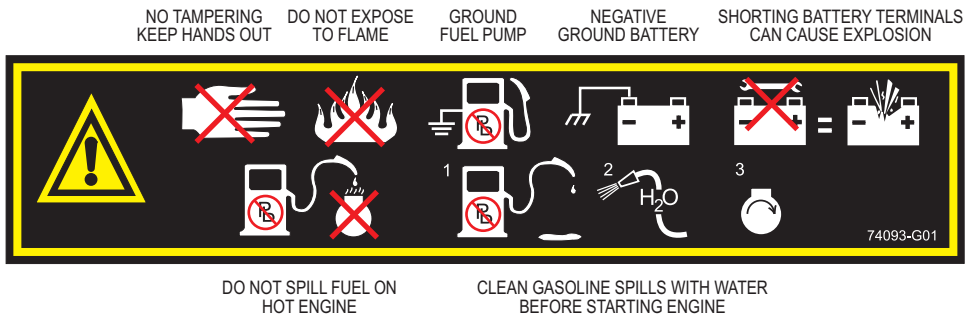

SAFETY

Governor Warning (P/N 608527)

Located on the governor bracket.

⚠ WARNING

DO NOT TAMPER WITH OR ATTEMPT TO CHANGE THE ADJUSTMENT OF THE GOVERNOR. GOVERNOR TAMPERING CAN RESULT IN SERIOUS PERSONAL INJURY AND WILL VOID THE VEHICLE WARRANTY.

608527

Bed Latch Warning (P/N 74099G01)

Located on the side panel near rear fender.

KEEP HANDS AND FINGERS AWAY FROM DUMP BED.



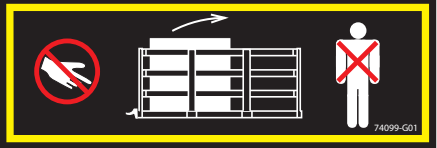





74099-G01

DO NOT STAND BEHIND DUMP BED.

Bed Load (P/N 74821G01)

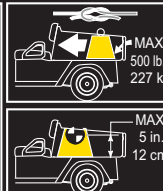
Located on the truck bed.

WARNING READ THE MANUAL	SECURE LOAD MAX BED WEIGHT 500 LBS or 227 KG	NO PASSENGERS IN LOAD BED	HIGH CENTER OF GRAVITY MAY CAUSE TIP OVER
			
<p>DO NOT FILL GAS CAN IN LOAD BED</p>	<p>MAX 5 in. 12 cm</p>	<p>MAX 100 lb. 45 kg</p>	<p>MAX 14° / 25%</p>
	<p>MAX CENTER OF GRAVITY HEIGHT 5" (12 CM) ABOVE FLOOR</p>	<p>MAX TAILGATE LOAD 100 LBS OR 45 KG</p>	

74821G01

Pinch Warning (P/N 651671)



651671

PINCH WARNING
KEEP HANDS AND FINGERS AWAY

Patent Label (P/N 10005569)

Located in the glove box (driver side)

PATENT NOTICE 10005569

This product or components thereof may be covered by one or more patents or pending applications

See patents.txtsv.com for details.



WARNING CANCER AND REPRODUCTIVE HARM

For more information, go to P65Warning.ca.gov/passenger-vehicle

SAFETY

For questions about the vehicle or the material in this manual, see the contact information on the first page or the back of this publication.

Certain replacement parts can be used independently and/or in combination with other accessories to modify the vehicle to permit the vehicle to operate at or in excess of 20 mph. When the vehicle is modified in any way by the Distributor, Dealer or customer to operate at or in excess of 20 mph on public streets or roads, UNDER FEDERAL LAW the modified product will be a Low Speed Vehicle (LSV) subject to the strictures and requirements of Federal Motor Vehicle Safety Standard 571.500. In these instances, pursuant to Federal law the Distributor or Dealer MUST equip the product with headlights, rear lights, turn signals, seat belts, top, horn and all other modifications for LSVs mandated in FMVSS 571.500, and affix a Vehicle Identification Number to the product in accordance with the requirements of FMVSS 571.565. Pursuant to FMVSS 571.500, and in accordance with the State laws applicable in the places of sale and use of the product, the Distributor, Dealer or customer modifying the vehicle also will be the Final Vehicle Manufacturer for the LSV, and required to title or register the vehicle as mandated by State law.

Information on FMVSS 571.500 is found at Title 49 of the Code of Federal Regulations, section 571.500. For information on-line, go to www.ecfr.gov.

The vehicle will NOT approve Distributor, Dealer or customer changes that change a product into a Low Speed Vehicle (LSV).

This vehicle meets the current applicable standard for safety and performance requirements.

MAXIMUM CARGO LOAD / MAXIMUM WEIGHT CAPACITY



Exceeding the weight capacities can cause the loss of vehicle control and possible injury or death.

Maximum Cargo Load Capacity	500 lbs. (226 kg)
Maximum Vehicle Weight Capacity	900 lbs. (409 kg)

- Do not exceed the maximum cargo load capacity.
- Do not exceed the maximum vehicle weight capacity (includes weight of operator, passenger, cargo, and accessories).

TIRE PRESSURE



Improper tire pressure or uneven tire pressure can cause the loss of vehicle control and possible injury or death.

Maintaining the correct tire inflation pressure is essential for safe vehicle operation. The inflation pressure can vary within the recommended range to suit the condition of the terrain.

TIRE PRESSURE RANGE	TERRAIN CONDITIONS	RECOMMENDATION
18 - 22 psi (124 - 152 kPa)	Hard surfaces or pavement	Inflate to higher pressure within the range; never exceed maximum pressure indicated.
	Soft terrain or turf	Inflate to lower pressure within the range to reduce potential damage to the terrain or turf.

OPERATOR SAFETY

Safe and responsible use of this vehicle is necessary to prevent dangerous conditions for the operator, passengers and other people in the area of operation. This section of the manual provides information on the safe operation of the vehicle. Make sure to read, understand and comply with all of this information to decrease the risk of personal injury or death.



Serious injury or death can occur if you do not follow the instructions and procedures shown in this owner's manual.

- Read this entire manual and all product labels carefully. Follow the safety information and operating procedures described.
- Operate your vehicle responsibly to prevent dangerous conditions for the operator, passengers and other people in the area of operation
- Operate the vehicle responsibly and keep the vehicle in safe condition of operation.

SAFETY

- A damaged vehicle or a vehicle that is not functioning properly is dangerous and must not be operated until repairs are made.
- Do not carry a passenger until you have a minimum of two hours driving experience on this vehicle.
- Keep feet, legs, hands, and arms inside the vehicle at all times.
- The driver must keep both hands on the steering wheel and both feet on the floor or pedals.
- Inspect the vehicle before each use to make sure it is in safe operating condition. Perform the pre-ride inspection described in this manual. See page 21.
- Always have the vehicle checked by an authorized dealer if it is involved in an accident.
- Always put the direction selector in forward (F) and engage the parking brake before you exit the vehicle.
- Remove the ignition key when the vehicle is not in use to prevent accidental starting, unauthorized use by someone below the age of 16, or someone without a driver's license and proper training.
- Drive the vehicle at appropriate speeds for the terrain and conditions. Be aware of environmental conditions that change the terrain and your ability to control the vehicle.
- Do not drive on excessively steep hills. Evaluate the terrain before descending a hill. Drive slowly and deliberately. Use the brake to limit speed and maintain control. Sudden braking or turning can cause the loss of vehicle control. Drive straight down the hill. Do not drive across the hill.
- Operate only in approved areas. Follow all applicable safety rules for the area.
- Avoid driving on terrain that is too rough for your vehicle's capabilities and your driving skills.
- Before you drive in the reverse direction, make sure the area behind the vehicle is clear. Accelerate slowly and avoid making sharp turns.
- Make sure the direction selector is in the correct position before pressing the accelerator pedal.
- Decrease the speed before and during turns.
- Decrease the speed when driving on wet or slippery surfaces.
- Bring the vehicle to a complete stop before moving the direction selector.
- Do not exceed the cargo or vehicle weight capacities. Do not exceed the occupant capacity. See *SPECIFICATIONS* on page 55 for the vehicle load and seat capacity.
- If there is a risk of lightning, leave the vehicle and look for a safe location to wait until the lightning has stopped.

Additional information about safety is included throughout this manual or can be obtained from your dealer.

⚠ WARNING Failure to operate this vehicle as instructed can cause collision, loss of control, or roll-over resulting in severe injury or death. Follow all safety warnings in this section of the owner's manual. See the **OPERATION** section of the owner's manual for operating procedures and additional safety information.

Unauthorized Operation



This vehicle is for adult use only. Any person below the age of 16 is not permitted to operate the vehicle.

Any person who does not have a valid driver's license is not permitted to operate the vehicle.

Any person who is below the height of 59 in. (150 cm) is not permitted to operate the vehicle.

Leaving the keys in the ignition allows unauthorized operation of the vehicle by someone under 16 years of age, an unlicensed driver or someone who does not meet the height requirement. Always remove the ignition key when the vehicle is not in operation.

Operating without Instruction



Operation of this vehicle without proper instruction increases the risk of an accident. The operator must understand how to operate the vehicle correctly in different situations and on different types of terrain.

All operators must read, understand, and comply with the owner's manual and all warning and instruction labels before operating the vehicle.

Alcohol or Drugs



Operation of the vehicle during or after consuming alcohol or drugs can adversely affect operator judgment, reaction time, balance and perception.

Never drink alcohol or use drugs or medications before or during operation of the vehicle.

Passenger

All passengers must be at least 59 in. (150 cm) tall. Passengers must be able to sit with their back against the seat, and both feet on the floor.

For additional safety and operational information, see *Driving with a Passenger* on page 24.

Before Operating

Perform the *PRE-RIDE INSPECTION* on page 21 before each use to make sure the vehicle is in safe operating condition. Failure to inspect and confirm that the vehicle is safe to operate increases the risk of an accident.

Follow all inspection and maintenance procedures and schedules described in this owner's manual. See *SCHEDULED MAINTENANCE* on page 35.

Load Operation

The weight of cargo and occupants affects vehicle operation. Carefully calculate how the vehicle is loaded and how to safely operate it. Follow the instructions in this manual for loading guidelines and tire pressure.

Do not exceed weight capacities specified for your vehicle. Capacities are listed in *Maximum Cargo Load / Maximum Weight Capacity* on page 11 of this manual, and also on the label affixed to the truck bed. As passenger weight increases, cargo weight needs to be adjusted to ensure the maximum vehicle weight capacity is not exceeded.

Tire pressure must be adjusted to accommodate the load being carried. See *Tire Pressure* on page 11 for pressure specifications.

Verify tire pressure, and drive slowly and carefully to maintain control of the vehicle if driving under any of the following conditions:

- passenger and/or cargo exceeds half the maximum weight capacity
- driving over obstacles
- towing
- climbing a hill

Fuel Handling Guidelines

Gasoline is flammable and can be explosive in some conditions. Use the following guidelines when handling fuel:

- Always use caution when handling gasoline.
- Refuel in a well-ventilated area.
- Turn off the engine before refueling.
- Use an approved gasoline container to store fuel.
- Remove portable gasoline containers from the vehicle and place on the ground before filling to prevent ignition caused by electrical static discharge.
- Do not smoke or allow open flames or sparks in or near the area where refueling is done or where gasoline is stored.
- Do not overfill the tank. Do not fill the tank neck.
- If any gasoline contacts skin, immediately wash with soap and water. If any gasoline gets on clothing, change immediately.

For refueling procedure, refer to *Fuel* on page 22.

Carbon Monoxide Exposure

Carbon monoxide is an odorless gas that is formed as a natural part of the combustion of hydrocarbon fuels.

Carbon monoxide is poisonous, and can cause loss of consciousness or death in a short period of time. Never start the engine or allow it to run in an enclosed area.

If you experience any of the following symptoms, stop the engine and get fresh air immediately:

- dizziness
- intense headache
- weakness and sleepiness
- vomiting
- muscular twitching
- throbbing in temples

Operate this vehicle outdoors or in well-ventilated areas only.

Driving in Reverse

Make sure the area behind the vehicle is clear before operating in reverse. After making sure it is clear and safe to operate in reverse, accelerate slowly. Avoid making sharp turns in reverse. Refer to *Driving in Reverse* on page 26 for operational information.

SAFETY

Driving a Damaged Vehicle

Driving a damaged vehicle is not safe.

If the vehicle has been involved in any type of accident, have it inspected by a qualified service dealer to verify that it is safe for operation.

Driving at Maximum Speeds

Maximum speed operation increases the risk of loss of control. Always drive at a speed that is appropriate for the terrain, visibility, operating conditions, and your skill and experience level. Use the brake to control speed and maintain control of the vehicle.

Driving on Pavement

Driving the vehicle on paved surfaces can affect handling characteristics and increase tire wear.

If possible, avoid driving on paved surfaces. If unavoidable, drive slowly, travel short distances, and avoid sudden turns or stops.

Driving on Public Roads

Driving this vehicle on public streets, roads or highways could result in a collision with another vehicle. Never drive this vehicle on any public street, road, or highway, including dirt and gravel roads, unless they are designated for off road use. Most areas prohibit the operation of this vehicle on public streets, roads, or highways and can result in traffic violations and fines.

Spark Arrestor and Use on Public Lands

Federal law requires that the spark arrestor be installed and functional when the vehicle is operated on public lands. Spark arrestor accessory kit 680463 is available by contacting an authorized dealer or customer care.

Off road operation on public lands in the USA is regulated by 43 CFR 420. Violations are subject to monetary penalties. Go to www.gpo.gov/fdsys to see federal regulations.

Turning

Improper or careless turning can cause loss of traction, loss of control, accident, or rollover. Do not turn quickly or at sharp angles. Do not turn at high speeds. Practice turning at slow speeds before attempting to turn at faster speeds.

Driving Uphill

Do not climb hills that are too steep for the vehicle or your driving abilities. Loss of vehicle control or rollover can result from climbing hills incorrectly. Refer to *Driving Uphill* on page 25 for operational information.

Driving Downhill

Inspect the terrain before descending a hill. Avoid driving across hills. Use the brake to limit speed and maintain control. Loss of vehicle control or rollover can result from driving downhill incorrectly. Refer to *Driving Downhill* on page 25 for operational information.

Stalling on a Hill

A rollover can result from stalling or rolling backward while climbing a hill. Drive uphill at a constant speed. See procedure on page 25 for maintaining control of your vehicle if it stalls on a hill.

Tires

Operating the vehicle with the incorrect tires or with the incorrect or uneven tire pressure can cause loss of control or an accident. Always use the size and type of tires specified for the vehicle. See Vehicle Specification for proper tire type and size. Always maintain the correct tire pressures as specified in *Tire Pressure* on page 11.

Slippery Terrain

Driving on rough, wet, or loose terrain increases the risk of loss of traction or control and accident or rollover. Drive slowly and use the correct turning procedures when operating on slippery surfaces.

Tires that have lost traction and then regain traction suddenly can cause loss of vehicle control or rollover.

Refer to *Slippery Surfaces* on page 24 for operational information.

HOT EXHAUST SYSTEMS

Exhaust system components are very hot during and after use. To avoid burn injuries, do not touch hot exhaust system components. Hot components can also cause a fire. Keep combustible materials away from the exhaust system. Check for buildup around the exhaust system after driving through high and dry grass.

VEHICLE LIFTING

The vehicle must be on a firm and level surface for lifting. Remain constantly aware that the vehicle is not stable during the lifting process. Do not get under a vehicle until you verify that it is stable on the jack stands. Never get under a vehicle while it is on a jack only. Put wheel chocks in front of and behind the wheels that are not being lifted. Do not allow anyone to remain or get on the vehicle at any time during the lifting process.

Read and comply with all warnings and follow the lifting procedures described on page 39.

VEHICLE MODIFICATION

Do not install any accessory not approved by the manufacturer. Do not modify the vehicle to increase the speed or power. Any modifications or installation of accessories not approved by the manufacturer can create a safety hazard and increase the risk of injury.

The warranty will be terminated if the vehicle is modified to increase vehicle speed or power.

The warranty may be terminated if the original (or equivalent) replacement parts are not installed on the vehicle.

The addition of some accessories can change the handling characteristics of the vehicle. Use only manufacturer-approved accessories, and familiarize yourself with their function and effect on the vehicle.

MAINTENANCE SAFETY

Routine and scheduled maintenance of this vehicle is necessary to keep the vehicle in safe and reliable condition. This section of the manual provides safety information for performing maintenance on your vehicle. Make sure to read, understand, and comply with all of this information to decrease the risk of personal injury or death.



WARNING Serious injury or death can occur if the instructions and procedures shown in this owner's manual are not followed.

- Read this entire manual and all product labels carefully. Follow the procedures and comply with the safety information in this manual while performing vehicle service or maintenance.
- Use the tools shown in the tool list and wear the specified safety equipment when performing vehicle service or maintenance.
- Remove all jewelry before servicing the vehicle.
- Do not allow loose clothing or hair to contact the moving parts.
- Do not touch hot objects.
- The drive wheels must be lifted and supported on jack stands before performing any service to the power-train while the motor is in operation.
- Use wheel chocks and support the vehicle on jack stands. NEVER get under a vehicle that is supported by a jack. Lift the vehicle following the instructions. See *LIFTING THE VEHICLE* on page 39.
 - When servicing the vehicle, always wear eye protection. Be careful when working around batteries, using solvents, or compressed air.
 - Use insulated tools within the battery area to prevent sparks or battery explosion.
 - To prevent the risk of battery explosion, keep all flammable materials, open flames or sparks away from the battery.
- Hydrogen gas is produced as a battery is charged. Charge the battery only in well-ventilated areas.
- Maintain constant awareness that some components are heavy, spring loaded, corrosive, explosive, can cause high amperage, or get extremely hot. Battery acid and hydrogen gas can cause bodily injury. Keep your hands, face, feet, and body away from any area that can expose them to injury in the event that an unexpected situation occurs.
- After making repairs or performing maintenance, test the vehicle in a safe area that is free from vehicle and person traffic.



FEATURES AND CONTROLS

NOTICE: Some accessories continue to operate with the key in the OFF position. Leaving these accessories activated after the vehicle is shut down can cause the battery to discharge.

KEY SWITCH

The key switch is a two-position switch.

- OFF; vehicle is disabled.
- ON; activates vehicle electronics and accessory power.

HEADLIGHT SWITCH

The headlight switch is a two-position switch.

Two-position:

- upper – on
- lower – off

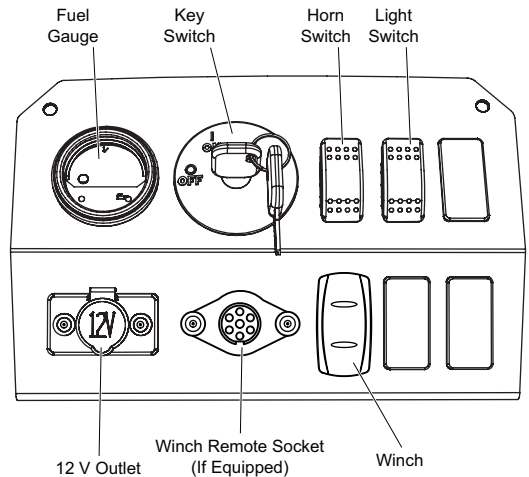

FUEL GAUGE WITH LOW OIL PRESSURE INDICATOR

The fuel gauge indicates the amount of gasoline in the fuel tank. F indicates a full tank and E indicates an empty fuel tank. The fuel gauge has a low oil pressure indicator. A low engine oil pressure condition is shown with a red indicator light.

CUP HOLDER

The vehicle has a center cup holder that will accommodate two beverage containers. Another cup holder is located to the left of the steering column and will accommodate a larger beverage container.

12V OUTLET

CAUTION Excessive use of accessories that are connected to the outlet can drain the battery.

A 12V auxiliary outlet is located on the center console.

With the key switch in the ON position, the auxiliary outlet supplies power for any lights and accessories that have a 12V plug.

WINCH REMOTE SOCKET (IF EQUIPPED)

NOTICE: Using the winch continuously for more than 2 minutes can drain the battery.

The winch remote can be connected to the socket for winch operation while outside of the vehicle. See *Winch Operation* on page 32. Do not leave the remote plugged into the winch remote socket while not in use. Leaving the remote plugged in may result in accidental activation and/or battery drain.

WINCH SWITCH (IF EQUIPPED)

NOTICE: Using the winch continuously for more than 2 minutes can drain the battery.

The winch switch is used to operate the winch while seated in the vehicle. See *Winch Operation* on page 32.

FEATURES AND CONTROLS

STEERING WHEEL

The steering wheel allows the driver to control the direction of travel.

BRAKE PEDALS

The brake pedal on vehicles with mechanical brakes is a combination brake and parking brake pedal.

Brake Pedal

The brake pedal is the bottom left pedal on the floorboard. Press the brake pedal to slow the speed or bring the vehicle to a complete stop.

Parking Brake Pedal

The parking brake is the upper pedal. It allows the operator to lock the brake when the vehicle is parked to prevent accidental movement.

To engage the parking brake, press the upper pedal until it locks into place.

Quickly press and release the lower pedal to disengage.

NOTICE: If the key switch is in the ON position and the parking brake is engaged, the brake will release when you press the accelerator pedal and can cause the vehicle to move suddenly. This is a feature to make sure the vehicle is not driven with the parking brake engaged. Pressing the accelerator pedal is not the recommended method to release the parking brake.

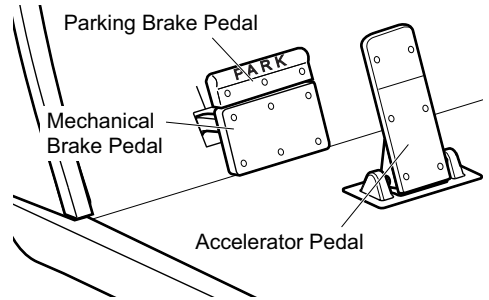

ACCELERATOR PEDAL

The accelerator pedal is the right pedal on the floorboard. It activates the engine and controls the acceleration of the vehicle.

Apply slow and steady pressure to the accelerator pedal to increase vehicle speed.

DIRECTION SELECTOR

The direction selector is on the seat panel and allows the operator to select F (forward) or R (reverse) to control the direction of travel.

The direction selector has a reverse warning buzzer that activates when in the R position.

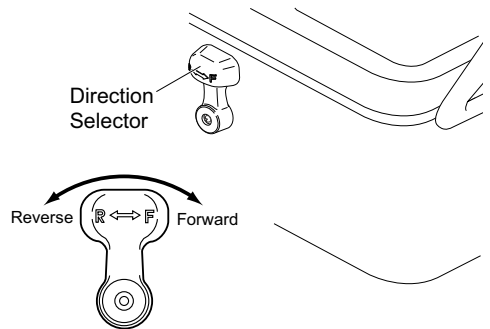

CHOKE

This vehicle is equipped with Electronic Fuel Injection and does not require a choke.

EFI MALFUNCTION INDICATOR LIGHT (MIL)

The MIL is located on the rear of the seat frame. Lift the truck bed to view the MIL. The MIL can be used to diagnose a problem and whether a technician will be required to service the vehicle. See *MALFUNCTION INDICATOR LIGHT (MIL)* on page 48.

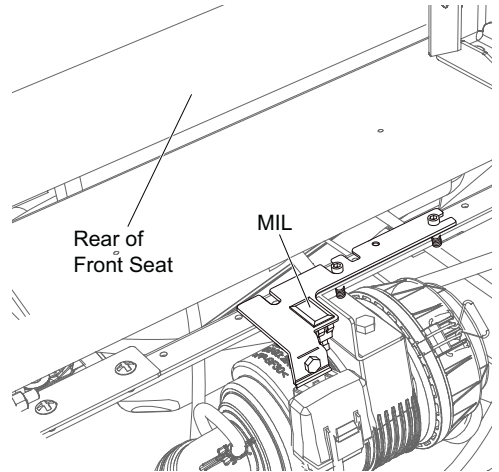

SEAT BOTTOM

The bench seat is designed for two occupants.

Lift up on either hip restraint to pivot the seat bottom forward and access the components underneath. Pivot and lift up on the seat to completely remove it from the vehicle.

GLOVE BOX / STORAGE COMPARTMENTS

The glove box provides storage space for small items. Glove boxes may be equipped with optional shelf and/or glove box doors.

FUEL TANK CAP

WARNING Always make sure the fuel cap is reinstalled after filling the tank. Do not operate the vehicle without the fuel cap correctly installed and tightened.

The fuel cap is located on the passenger side of the vehicle. See *Fuel* on page 22 for fueling information.

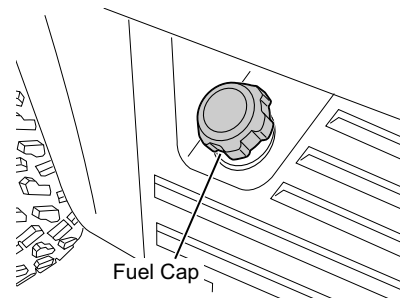

CANOPY TOP AND WINDSHIELD

WARNING The canopy top does not provide protection from rollover or falling objects.

The windshield does not provide protection from tree branches or moving objects.

CAUTION To prevent damage to the vehicle, do not hold on to the canopy top struts.

The canopy top and windshield provide some protection from the elements, but do not keep the operator and passenger dry in heavy rain.

This vehicle is not equipped with seat belts, and the canopy top is not designed to provide rollover protection. In addition, the canopy top does not protect against falling objects, nor does the windshield protect against flying objects and tree limbs.

FEATURES AND CONTROLS

TRUCK BED

To prevent injury and property damage, follow all warnings, procedures, and weight capacities described on the label in the truck bed as well as the ones in this owner's manual. See *HAULING CARGO* on page 26 and *DUMPING THE TRUCK BED* on page 28.

The tailgate can be opened for loading and unloading cargo. Open the tailgate latches and lower the tailgate. Lift the tailgate and secure the latches to close the tailgate.

Manual Bed Release Lever

The truck bed can be tilted by lifting up the release lever on either side of the vehicle. See *DUMPING THE TRUCK BED* on page 28.

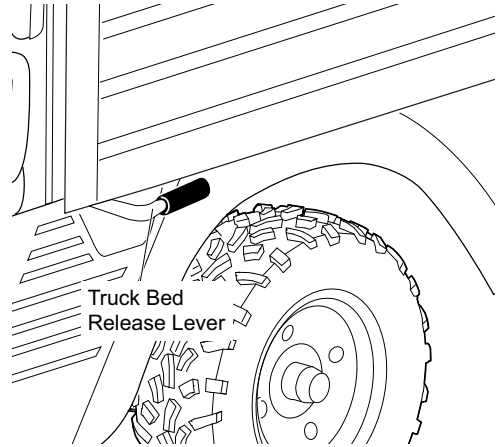

OPERATION

SAFETY



Failure to operate the vehicle correctly can result in a collision, loss of control, accident or rollover, and cause serious injury or death. Follow all operation procedures in this section of the manual. Read and comply with all safety warnings in the safety section of

this owner's manual.

BEFORE INITIAL USE

To prepare the new vehicle for operation, complete the following:

- Remove the protective plastic from the seats.
- Check for possible leaks that may have developed during shipment of the vehicle.
- Charge the battery.
- Fill the tank with the correct fuel.
- Perform the following pre-ride inspection.

PRE-RIDE INSPECTION

Inspect and verify that the vehicle is in safe operating condition before each use to decrease the risk of an accident. Check the items in the table to help ensure safe and reliable operation.

Item	Check	Page
Brake system/pedal travel	Check for proper operation.	50
Parking brake	Ensure vehicle does not roll when the parking brake is engaged.	
Front suspension	Inspect. Lubricate if necessary. Check for loose or missing hardware.	
Rear suspension	Inspect. Lubricate if necessary. Check for loose or missing hardware.	
CV boots	Inspect for damage. Replace if necessary.	
Steering	Check for smooth and free operation.	
Tires	Check condition and pressure.	40
Wheel hardware	Check for loose or missing hardware.	
Frame hardware	Check for loose or missing hardware.	
Fuel and engine oil	Check for correct levels.	38
Fluid leakage	Inspect vehicle for leaks.	
Switches	Check operation.	
Reverse warning alarm	Check operation.	
Air filter	Inspect; clean or replace if necessary.	47
Headlights	Check operation.	42
Brake light / taillights	Check operation.	42
Starter / generator belt	Check condition.	46

OPERATION

ENGINE BREAK-IN

Correct operation of the engine during the break-in period is essential to the performance, reliability, and life of the engine.

The engine break-in period is:

- the first 50 operating hours of a new engine
- the first 50 operating hours of an engine that has been completely disassembled
- the first few minutes until the engine is warm at each operation

During these break-in periods, operate the vehicle in the following manner:

- Avoid high engine speeds.
- Avoid long periods of idle time.
- Avoid long operating times at low engine speed.
- Avoid long operating times at the same engine speed.
- Avoid long operating times with a full load.
- Vary the engine speed during operation.
- Apply quick bursts of acceleration after the engine has warmed up.

CVT BELT BREAK-IN

The CVT belt break-in period is the first hour of operation on each new belt.

During the CVT belt break-in period, follow the same guidelines as described for engine break-in operation. See *Engine Break-In* on page 22.

FUEL

Refer to *Fuel Handling Guidelines* on page 13 for more information regarding handling and storage of fuel.



Refuel only in well-ventilated areas.

Do not add fuel near open flame or electrical items that can cause a spark.



Wear eye protection to protect from splashed fuel and fuel vapors.



Never use cigarettes in or near the area where refueling is done or fuel is stored.

Inspect the fuel cap, tank, and other components for leaks or damage that can cause a hazardous condition.

Do not overfill the tank. Do not fill the tank neck.

Never operate the vehicle with the fuel tank cap removed.

NOTICE: Oxygenated or reformulated gasoline, is mixed with alcohols or ethers. Excessive amounts of these blends can damage the fuel system or cause performance problems. If any performance problems occur, use gasoline with a lower percentage of alcohol or ether.

Use clean, regular grade unleaded fuel. An Ethanol blend of no more than 10% is acceptable.

1. Remove the fuel refill cap that is located in front of the passenger side rear wheel.
2. Fill the tank with clean, automotive grade gasoline. See the following chart for requirements.

Fuel		NOTES
Grade requirement	Regular 87 octane	High altitude or heavy use/load applications can benefit from higher octane gasoline.
Ethanol content	10% maximum permissible	Exceeding the maximum permissible ethanol concentration can deteriorate the engine fuel system and starting performance.
Methanol content	Not permissible	The use of fuels containing methanol is not permissible.

3. Replace the cap when refueling is complete.

STARTING AND STOPPING THE ENGINE



WARNING

Unintentional roll-back of the vehicle could cause severe personal injury or vehicle damage. To reduce the possibility of vehicle roll-back, keep the brake fully pressed until the engine has started.

NOTICE: *Avoid full throttle starts and fast acceleration until the engine has warmed up.*

Always start the engine outdoors or in a well-ventilated space.

1. Sit in the driver's seat.
2. Press and hold the brake pedal. If the vehicle is equipped with hydraulic brakes, release the hand operated parking brake.
3. Insert the key and turn the key switch to the ON position.
4. Move the direction selector to the appropriate position.

NOTICE: *When the direction selector is moved to the reverse position, a warning alarm will activate to indicate that the vehicle is ready to run in reverse.*

5. Slowly press the accelerator pedal to start the engine.
6. When the accelerator pedal is released, the ignition circuit is de-energized and the engine stops. To stop the vehicle more quickly, press the brake pedal.
7. Engage the parking brake and remove the key from the switch before exiting the vehicle.

Starting on a Hill



WARNING

Unintentional roll-back of the vehicle could cause severe personal injury or vehicle damage. To reduce the possibility of vehicle roll-back, keep the brake fully pressed until the engine has started.

Remove the ignition key when exiting the vehicle to prevent accidental starting or unauthorized use.



CAUTION

To decrease the risk of permanent damage to the drive train, do not allow roll-back when you start the vehicle on a hill. Do not use the accelerator and engine to hold the vehicle at a stop on a hill.

1. Press the brake pedal with your left foot when releasing the parking brake. Keep pressure on the pedal to prevent the vehicle from rolling back.
2. Press the accelerator pedal with your right foot as you release the brake pedal.
3. Press the accelerator pedal with gradual and steady pressure until the vehicle reaches the desired speed.

ACCELERATING



WARNING

Accidental movement of the accelerator pedal can cause the vehicle to suddenly move and cause severe injury or death.

Make sure the key is in the OFF position and the parking brake is engaged any time the vehicle is parked.

Apply slow, steady pressure to the accelerator pedal to increase vehicle speed. When you release the accelerator pedal, the engine will stop running.

NOTICE: *On mechanical brake vehicles, if the key switch is in the ON position and the parking brake is engaged, the brake releases when you press the accelerator pedal and can cause the vehicle to move suddenly. This is a feature to make sure the vehicle is not driven with the parking brake engaged. Pressing the accelerator pedal is not the recommended method to release the parking brake.*

OPERATION

BRAKING

⚠ WARNING

When carrying cargo or towing a trailer, the weight of the load will increase the braking distance required to slow or stop the vehicle. Not allowing for increased braking distance under load can cause an accident or injury.

1. Release the accelerator pedal completely.
2. Press the brake pedal to slow the vehicle speed or stop the vehicle completely.
3. Practice slowing and stopping using the brake to become familiar with the controls.

DRIVING PROCEDURE

1. Perform the pre-ride inspection. See page 21.
2. Sit in the driver's seat.
3. Check the surroundings and determine the path of travel.
4. Release the parking brake.
5. Insert the key and turn the key switch to the ON position.
6. Move the direction selector to the appropriate position.
7. With both hands on the steering wheel, release the brake and immediately start to apply gradual and steady pressure to the accelerator pedal.
8. Practice maneuvering the vehicle using the accelerator and brake pedals. Drive slowly and cautiously until you are comfortable with the controls.
9. Do not drive with a passenger until you have at least two hours of experience driving this vehicle.

Coasting

⚠ WARNING

Vehicle speed can increase quickly when driving downhill. Allowing the vehicle to coast downhill at high speeds can cause a loss of control and result in severe injury or death. Limit your vehicle speed by pressing the brake.

Do not allow the vehicle to coast at speeds that are above the maximum recommended speed. Apply constant brake pressure when descending a hill to control the speed of the vehicle.

DRIVING WITH A PASSENGER

- All passengers must be at least 59 in. (150 cm) tall. Passengers must be able to sit with their back against the seat and both feet on the floor.
- Do not allow more than one passenger in the vehicle with a truck bed. If equipped with a rear facing seat, do not allow more than one passenger on the front seat and two passengers on the rear facing seat.
- Do not allow a passenger to ride anywhere on the vehicle except the passenger seat.
- Travel at speeds appropriate for your skills, your passenger's skills and the operating conditions. Avoid unexpected or aggressive maneuvers that could cause discomfort or injury to the passenger.
- Handling characteristics can change with the added weight of a passenger. Allow more time and distance for braking.

SLIPPERY SURFACES

⚠ WARNING

Skidding or sliding can cause a loss of control. Skidding or sliding can cause a rollover if tires have lost traction, then regain traction suddenly. When operating on slippery surfaces, travel at reduced speed to help maintain control of the vehicle.

When operating in conditions such as ice, water, muddy trails, loose gravel or freezing temperatures, follow these guidelines:

- Do not operate on excessively rough, slippery, or loose terrain.
- Slow down before entering potentially slippery areas.
- Maintain a high level of alertness, carefully evaluate the path of travel, and avoid quick, sharp turns.
- Correct a skid by turning the steering wheel in the direction of the skid. *Never apply the brakes during a skid.*

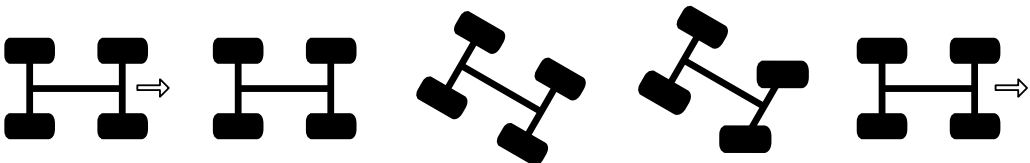

DRIVING UPHILL

When driving up a hill, follow these guidelines:

- Drive straight up the hill.
- Avoid excessively steep hills.
- Keep both feet on the floor or a pedal.
- Check the terrain before driving up a hill. Do not try to climb hills that have excessively slippery or loose surfaces.
- Drive at a steady rate of acceleration and speed.
- Do not drive over the crest of a hill at high speeds. An obstacle, sharp drop, another person, or another vehicle could be on the other side of the hill.
- Do not attempt to drive up a hill that is beyond your skill level.

TRAVERSING HILLSIDES

Traversing a hillside is not recommended. Improper procedure can cause a loss of control or a rollover. Avoid crossing the side of a hill unless absolutely necessary. If traversing a hillside is unavoidable, check the terrain and determine if it can be accomplished safely. Do not proceed if the terrain is beyond the vehicle or driver's ability.

If traversing a hillside is unavoidable, follow these guidelines:

- Drive slowly.
- Use extreme caution.
- Avoid crossing the side of a hill that has a slippery surface.
- Avoid crossing the side of a steep hill.
- When traversing a hillside that has soft terrain, it may be necessary to steer slightly uphill to keep the vehicle traveling in a straight line.
- If you feel that you are losing control of the vehicle, steer downhill if possible to regain control.

DRIVING DOWNHILL

 **WARNING** When carrying cargo or towing a trailer, the weight of the load will increase the braking distance required to slow or stop the vehicle. Not allowing for increased braking distance under a load can cause an accident or injury.

When driving down a hill, follow these guidelines:

- Avoid excessively steep hills.
- Check the terrain carefully before descending any hill.
- Never drive down hills with excessively slippery or loose surfaces.
- Drive slowly.
- Drive straight down the hill. Avoid descending the hill at an angle that could cause the vehicle to lean sharply to one side.
- Apply light and constant pressure to the brakes to maintain slow speed and control of the vehicle.

STALLING ON A HILL

A rollover can result from stalling or rolling backward while climbing a hill. Drive uphill at a constant speed.

If your vehicle completely stalls while climbing a hill:

1. Apply the brakes.
2. Verify that the area behind you is clear.
3. Put the transmission in R (reverse).
4. Use steady brake pressure to control the speed, and allow the vehicle to slowly roll straight downhill.

If your vehicle begins to roll downhill:

1. Do not press the accelerator.
2. Apply the brakes gradually until the vehicle fully stops.
3. Verify that the area behind you is clear.
4. Put the transmission in R (reverse).
5. Use steady brake pressure to control the speed, and allow the vehicle to slowly roll straight downhill.

OPERATION

DRIVING IN REVERSE

When driving in reverse, follow these guidelines:

- Check that the area behind the vehicle is clear of obstacles and people.
- Check left and right fields of vision before driving in reverse.
- Do not back down a steep hill.
- Drive in reverse slowly.
- Press the brakes lightly for stopping.
- Accelerate slow and steady.
- Avoid turning at sharp angles.

PARKING THE VEHICLE

NOTICE: When parking the vehicle inside a garage or structure, the space must be well ventilated. Park the vehicle away from any source of flame or sparks, including any appliance with a pilot light.

Park the vehicle on a flat surface if possible. If parking on an incline is unavoidable, be sure to chock the wheels as shown in the following illustration to keep the vehicle from rolling.

1. Press the brake to stop the vehicle.
2. Engage the parking brake.
3. Turn the key switch to OFF.
4. Remove the key from the key switch to prevent unauthorized use.
5. If parking on an incline, chock the wheels on the downhill end as shown in the following illustration.

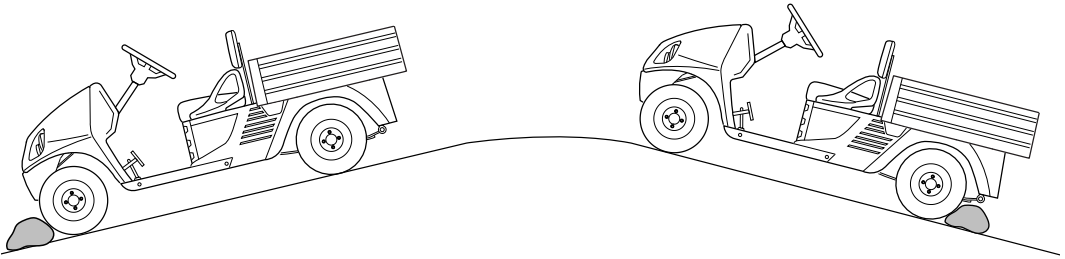

BATTERY

NOTICE: Using the winch continuously for more than 2 minutes can drain the battery.

NOTICE: Heavy use of accessories or leaving accessories turned on when the vehicle is not being used can drain the battery and leave insufficient reserve to start the vehicle.

The vehicle uses a starter/generator to start the engine and charge the battery. The engine does not idle; so the battery does not charge while the vehicle is stopped. Do not operate lights and other accessory items excessively while the vehicle is stopped. Turn off all accessories when the vehicle is stopped.

The generator can supply up to 35 amps. Operation of all accessories can cause the discharge of the battery even if the engine is running and the generator is operating. Discharging the battery is known as deep cycling. The battery is not a deep cycle model. It is a starting battery. Multiple deep cycling causes early failure of the battery.

If the battery discharges, charge it with a 12-volt charger that is rated at 10 amps or less and according to the instructions supplied by the manufacturer of the charger.

HAULING CARGO

⚠ WARNING

Hauling cargo incorrectly can alter the vehicle handling characteristics and cause a loss of control, brake instability, and possibly lead to serious injury or death.

Never exceed the maximum weight capacity of the vehicle. The total load (operator, passenger, accessories, cargo and load on hitch) must never exceed the maximum weight

capacity of the vehicle. See the chart in *Maximum Cargo Load / Maximum Weight Capacity* on page 27.

Position the load as far forward, and as low as possible in the truck bed.

Secure all loads before operating. Unsecured loads can shift and create unstable operating conditions.



Operating the vehicle with passengers in the truck bed can result in severe injury or death. Never allow a passenger to ride in the truck bed. Passengers must always ride seated in the passenger seat.

Drive slowly and carefully.

Operate only with stable and safely arranged loads. When handling loads that are impossible to center in the truck bed, make sure the load is secured as tightly as possible and operate the vehicle with extra caution.

ate the vehicle with extra caution.

Always attach a tow load to the rear hitch of the vehicle.

Reduce speed and allow greater distances for braking when hauling cargo.

Heavy loads affect braking and handling characteristics. Use extra caution when applying brakes with a heavily loaded vehicle. Avoid terrain or situations that may require reverse downhill travel.

Use extra caution when operating with loads that extend over the truck bed sides. Stability and maneuverability can be affected and increase the risk of a rollover.

This vehicle is designed to carry or tow specific capacities. Read and comply with the load distribution warnings on the warning label affixed to the bed. The total load (operator, passenger, accessories, cargo and load on hitch) must never exceed the maximum weight capacity of the vehicle.

Maximum Cargo Load / Maximum Weight Capacity

Maximum Cargo Load Capacity	500 lbs. (226 kg)
Maximum Vehicle Weight Capacity	900 lbs. (409 kg)

- Do not exceed the maximum cargo load capacity.
- Do not exceed the maximum vehicle weight capacity (includes the weight of the operator, passenger, cargo and accessories).

OPERATION

TRUCK BED OPERATION

⚠ WARNING

Failure to follow these instructions can cause personal injury, damage the vehicle or cause the vehicle to tip over. Be aware of the load when operating the vehicle. Read, understand and follow the warning label attached to the front of the truck bed.

Do not allow passengers to ride in the truck bed. A sudden move or stop can cause severe injury or death to passengers in the truck bed.

Before operating, make sure the area behind the vehicle is clear.

Load Bed (P/N 74821G01)

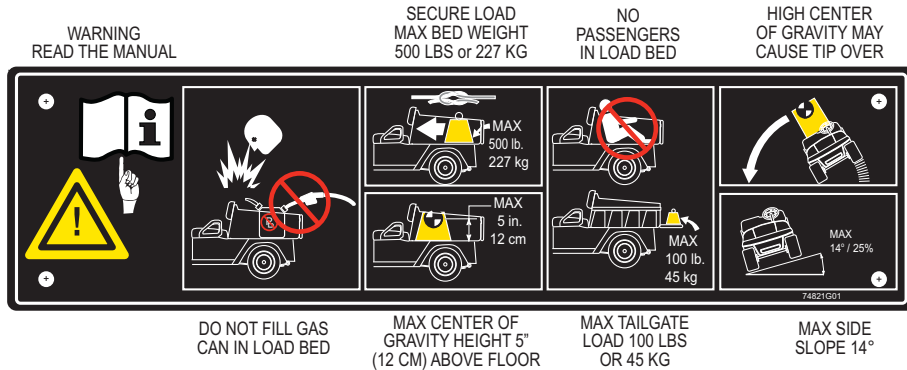

A truck bed warning label is attached to the inside front of the truck bed. Understand and comply with the warnings on this label for safe operation of the vehicle.

- See the truck bed warning label for maximum load.
- Position the load in the truck bed as far forward as possible.
- Make sure the center of gravity of the load is within the height limit shown on label.
- Secure the load to the truck bed.
- Be aware of the load when you operate the vehicle.
- Do not allow passengers to ride in the truck bed. Do not drive the vehicle with the truck bed lifted or with the tailgate unsupported.

⚠ WARNING

Never fill a gas container in the truck bed. Static discharge can ignite gasoline vapor and cause an explosion.

Always put the gasoline container on the ground before filling. Never fill a gasoline container in the truck bed. Static electricity is built up during the fueling process and can discharge and cause the gasoline vapor to ignite.

DUMPING THE TRUCK BED

⚠ WARNING

If the bulk of the cargo weight is at the rear of the bed, the bed may unexpectedly dump when the release lever is pulled and cause serious injury to anyone close by. Never pull the release lever unless the load is positioned evenly or located at the front of the truck bed.

Never leave the truck bed in the upright position after emptying the cargo. The bed can unexpectedly close and cause serious injury. Never drive the vehicle with the truck bed in the raised position.

1. Select a level location to dump the truck bed load. Do not attempt to dump or unload the vehicle if it is on an incline.
2. Apply the brakes and engage the parking brake on vehicles with mechanical brakes.

3. Put the direction selector in forward (F).
4. Exit the vehicle.
5. Make sure the cargo is positioned evenly or located at the front of the truck bed.
6. Release the tailgate latches.
7. Manual bed lift vehicles:
 - a. Stand clear and pull the release handle. Lift up on the truck bed to dump the cargo.
 - b. When the truck bed is empty, lower the bed back into place.
 - c. Push down to latch the bed.
- Electric lift vehicles:
 - a. Press the top of the switch to activate the electric lift and raise the bed.
 - b. Press the bottom of the switch to lower the bed back into place.
8. Close and latch the tailgate.

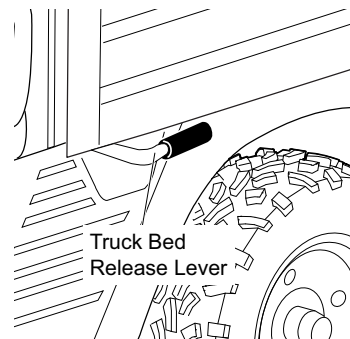

TOWING

NOTICE: Vehicles must be equipped with a rear hitch to tow a load.



WARNING Attach a trailer to the tow hitch only. Attaching the trailer at any other location can cause a loss of vehicle control.

Do not attach baskets or extensions to the hitch receiver. These types of items change the performance qualities of the vehicle and cause dangerous handling characteristics, possible rollover, or vehicle damage.

When towing a load, follow these guidelines:

- Do not tow more than the recommended towing weight for the vehicle. See the following table and the Vehicle Specifications.

VEHICLE LOADING	MAX. WEIGHT
Occupant Capacity	400 lb (181.4 kg)
Cargo Capacity	500 lb (226.8)
Vehicle Rated Capacity = Occupant + Cargo	900 lb (408.2 kg)
VEHICLE WEIGHT	
Curb Weight (includes fuel)	1092 lb (495 kg)
Gross Weight = Curb Weight + Rated Capacity	1992 (904 kg)
VEHICLE TOWING (0% - 20% GRADE)	
Maximum Trailer Tongue Weight	150 lbs. (68 kg)
Maximum Gross Trailer Weight	1200 lbs. (544.3 kg)
Maximum Vehicle Combined Towing Weight = Curb Weight + Rated Capacity + Trailer	2203 lbs. (999.3 kg)
Maximum Vehicle Drawbar (Level Ground & Improved Surfaces)	500 lbs. (2224 N)

- The total capacity of the vehicle, operator, passenger, load bed contents, and accessories must be reduced to compensate for the trailer and load.
- The range of motion of the trailer is limited by the ball and hitch. Do not tow a trailer on rough terrain.
- Drive slowly and carefully.
- Towing a load increases braking distances required for slowing or stopping the vehicle.
- Do not attach baskets or extensions to the hitch receiver.
- Avoid parking on an incline.
- Do not operate on a grade exceeding 20%.
- Always secure the cargo.

WINCH

NOTICE: Using the winch continuously for more than 2 minutes can drain the battery.

The safety warnings and information in this section apply if your vehicle has a winch.



WARNING Improper or irresponsible use of the winch can result in severe injury or death. Always follow all winch instructions and warnings in this manual.

WINCH SAFETY

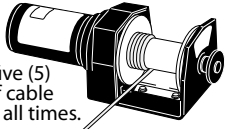
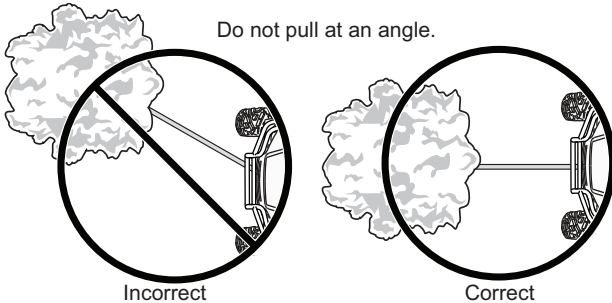
- Read and understand this entire section before operating the winch.
 - Inspect the winch and winch cable for damage before each use.
 - Never use alcohol or drugs before or during operation of the winch.
 - Do not allow any person below the age of 16 to operate the winch.
 - Always wear eye protection and heavy gloves while operating the winch.
 - Always keep body, hair, clothing, and jewelry clear of the winch cable and hook while operating the winch.
 - Never attempt to jerk a load attached to the winch with a moving vehicle. See *Shock Loading* on page 34.
 - Always keep the area around the vehicle, winch, winch cable, and load clear of people and distractions while operating the winch.
 - Always turn the vehicle ignition switch OFF when the vehicle and winch are not being used.
 - Maintain at least five full turns of winch cable wrapped around the winch drum at all times. The friction provided by the wrapped cable allows the drum to pull on the winch cable and move the load.
- 
- If pulling the vehicle itself, engage the neutral lock. If pulling another vehicle, apply the parking brake on the vehicle performing the winching to prevent it from moving while winching. Use wheel chocks if needed.
 - Always align the vehicle and winch with the load directly in front of the vehicle as much as possible. Avoid winching with the winch cable at an angle to the vehicle's centerline whenever possible.
 - If winching at an angle is unavoidable, follow these precautions:
 - Be observant of the winch drum. Do not allow the winch cable to stack or accumulate at one end of the winch drum. If the winch cable stacks, damage to the winch and winch cable can occur.
 - If stacking occurs, stop winching. Follow step 13 on page 33 to feed and rewind the cable evenly before continuing the winch operation.
 - Never winch up or down at sharp angles. It can destabilize the winching vehicle and possibly cause unexpected movement.
 - Never winch loads that exceed the rated capacity of the winch.
 - The winch motor can become hot during use. After winching for more than 45 seconds, or if the winch stalls during operation, stop winching and allow the winch motor to cool down before using it again.
 - Never touch, push, pull, or straddle the winch cable while winching a load.
- 

WINCH

- Even if wearing heavy gloves, never let the winch cable run through your hands.
- Never release the clutch on the winch when the winch cable is under a load.
- Never use the winch for lifting or transporting people.
- Never use the winch to hoist or suspend a vertical load.
- Never immerse the winch in water. Take the winch to a certified dealer for service if immersion occurs.
- Never winch the hook fully into the winch. The hook can damage winch components.
- Disconnect the remote control from the vehicle when the winch is not in use to prevent accidental activation and use by unauthorized persons.
- Never apply grease or oil to the winch cable. Grease and oil will cause the winch cable to collect debris and shorten the life of the cable.



WINCH OPERATION

Read all of the *Winch Safety* beginning on page 31 before operating your winch.

NOTICE: *Practicing operation and use of the winch before it is needed to perform a job is recommended.*

WARNING Improper or irresponsible winch use can result in severe injury or death. Comply with all winch instructions and warnings in this manual.

Since all winching situations are different, follow these important guidelines:

- Evaluate the winching operation before performing it.
 - Proceed slowly and deliberately.
 - Maintain constant awareness of your surroundings.
 - Maintain constant awareness that the winch is very powerful.
 - Change the winching strategy if the current strategy is not working.
 - Seek assistance if needed.
1. Inspect the vehicle, winch, winch cable, and winch controls for any signs of damage or parts in need of repair or replacement before each use. Replace the cable if signs of wear or damage is visible. Never operate a winch in need of repair or service.
 2. If pulling the vehicle itself, engage the neutral lock. If pulling another vehicle, apply the parking brake on the vehicle performing the winching to prevent it from moving while winching. Use wheel chocks if needed.
 3. Use a hook strap when handling the hook. Never hook the winch cable to itself.

WARNING Never put your fingers into the hook. Doing so could lead to severe injury.

- a. Attach the hook onto the load or use a tow strap or chain to secure the load to the winch cable.

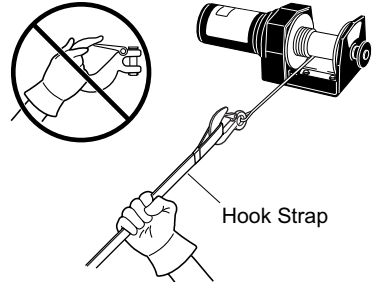

WARNING Do not use a recovery strap as a tow strap. Recovery straps are designed to stretch so they store energy. The stored energy in the recovery strap will release if the winch cable breaks. The use of recovery straps can cause severe injury or death.

Do not hook the winch cable back onto itself. Doing so will damage the winch cable and can result in winch cable failure.

Replace the winch cable at the first sign of damage to prevent severe injury or death in the event of failure. Replace factory approved replacement parts.



- b. If possible, keep the winch cable aligned with the centerline of the winching vehicle to help maintain even spooling of the winch cable.

- c. If freeing a stuck vehicle by attaching to a tree, use an item such as a tow strap to avoid damaging the tree during winch operation. Sharp cables and chains can damage or kill trees.
 - d. The safety latch on the winch cable hook must be fully seated when the load is attached.
 - e. Never operate the winch with a damaged hook or latch. Damaged parts must be replaced before winch operation.
4. Never remove the hook strap from the hook until the operation is complete.
 5. Release the winch clutch and pull out the winch cable.

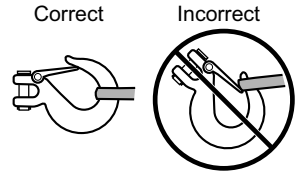

6. Pull out as much cable as possible to maximize the winch's pulling capacity. Maintain at least five full turns of winch cable wrapped around the winch drum at all times. The friction provided by the wrapped cable allows the drum to pull on the winch cable and move the load.

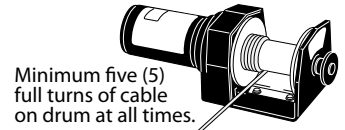

7. Read and follow the information below for winch damping to ensure safe winch use.

- a. To absorb energy that could be released by a winch cable failure, always put a damper on the winch cable. A damper can be a heavy jacket, tarp or other soft, dense object. A damper can absorb much of the energy released if the winch cable breaks when winching. Use of a tree limb can help as a damper if no other items are available.
- b. Lay the damper on top of the mid-point of the winch cable length that is spooled out.
- c. On a long pull, it may be necessary to stop winching and reposition the damper so that it is always near the mid-point of the cable. Always release the tension on the winch cable before repositioning the damper.
- d. Never stand in direct line with the winch cable. Never allow others to stand near or in line with the winch cable during winch operation.

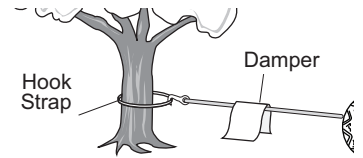

8. Never use damaged or worn straps, chains or other rigging items.
9. The only time a winch-equipped vehicle should be moving when the winch is in use is when the winching vehicle itself is stuck. Follow these guidelines when winching a stuck vehicle.
 - a. Release the winch clutch and spool out the necessary length of winch cable.
 - b. Align the cable as close as possible to the winching vehicle centerline.
 - c. Attach the cable hook to the anchor point or the stuck vehicle frame.
 - d. Re-engage the clutch on the winch.
 - e. Slowly winch in cable slack.
 - f. Shift the stuck vehicle to the lowest gear available.
 - g. Slowly and carefully press the accelerator pedal and winch together to free the vehicle.
 - h. Stop winching as soon as the stuck vehicle is able to propel itself without the help of the winch.
 - i. Remove the cable hook.
 - j. Rewind the cable evenly back onto the drum.
10. To prevent damage to the vehicle, do not attempt to winch another stuck vehicle by attaching the cable to a suspension component, brush guard, bumper or cargo rack. Always attach the cable to the vehicle frame or hitch.
11. Extensive winching will drain the battery on the winching vehicle. If winching for long periods of time, allow the engine to run while operating the winch to prevent battery drainage.
12. The winch motor can become hot during use. After winching for more than 45 seconds, or if the winch stalls during operation, stop winching and allow the winch to cool down for 10 minutes before using it again.
13. If it is necessary to redistribute the winch cable on the drum after winching in complete, use the following procedure:
 - a. Find an assistant to help.
 - b. Release the clutch on the winch.
 - c. Pull the cable out.
 - d. Re-engage the clutch.
 - e. Have the assistant pull the winch cable tightly with about 100 lbs. (45 kg) of tension using the hook strap.
 - f. Slowly retract the cable while the assistant moves the end of the cable back and forth horizontally to evenly distribute the cable on the drum. This process reduces the chance of the cable wedging itself between lower layers of the cable.

WINCH

WINCH CABLE CARE

For your safety, use factory approved replacement parts.

⚠ WARNING Replace the winch cable at the first sign of damage to prevent severe injury or death in the event of failure.

- Always inspect the winch cable before each use. Inspect for wear or kinks in the cable.
 - A kinked winch cable made of wire rope is shown at right. Even after being straightened out, this cable has been permanently and severely damaged. Discontinue use of a cable in this condition.
 - A winch cable made of synthetic rope should be inspected for signs of fraying. Replace the cable if fraying is visible.
 - Inspect the winch cable for fused or melted fibers, indicated by stiffness and a smooth or glazed appearance. Discontinue use of a winch cable in this condition.

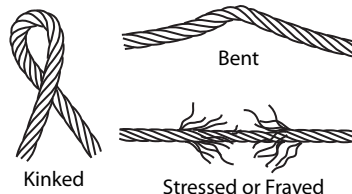

SHOCK LOADING

The winch cable is designed and tested to withstand the loads produced by the winch motor when operated from a stationary vehicle. The winch and winch cable are not designed for shock loading.

Practices that produce shock loading on a winch cable include:

- Abrupt acceleration of the vehicle against the pull of the winch cable, which causes immediate force on the winch cable that exceeds the force the cable is designed to withstand.
- Jogging the winch by quickly turning the winch ON and OFF repeatedly, which puts extra load on the winch, winch cable and generates excessive heat from the motor.
- Using the winch to tow vehicles or other objects.

⚠ WARNING A winch cable is not designed for shock loading. Shock loading can tension a cable beyond its strength and cause it to break. A broken winch cable under high loading conditions can cause severe injury or death to anyone in the area.

When using the winch, use the following guidelines:

- To avoid generating high winch cable loads that may exceed the strength of the cable:
 - Never use the winching vehicle to take up slack in the winch cable by moving the vehicle.
 - Never use the winching vehicle to move the object being winched; use the winch only.
- Never jog the winch (quickly turn the winch ON and OFF repeatedly).
- Never tow a vehicle or other objects with a winch. Towing an object with a winch produces shock loading of the cable even when towing at low speeds. Towing from a winch also positions the towing force high on the vehicle and cause instability of the vehicle.
- Never use recovery straps with the winch. Recovery straps are designed to stretch, so they store energy. The stored energy in the recovery strap will release if the winch cable breaks. The use of recovery straps can cause severe injury or death.
- Never use the winch as a tie down to secure a vehicle to a trailer or other transportation vehicle. Using a winch as a tie down can also cause shock loading that can damage the winch, winch cable or vehicles.

WINCH MAINTENANCE SAFETY

⚠ WARNING Improper or lack of maintenance and service could lead to severe injury or death. Always follow all winch instructions and warnings in this manual.

- Always inspect the winch before each use. Inspect for worn or loose parts including mounting hardware. Never use the winch if any part needs repair or replacement.
- Make sure the winch motor is cool before servicing the winch.
- Always disconnect the battery connections before working on the winch to prevent accidental activation.
- For your safety, always replace winch parts, including the cable, with factory approved replacement parts.
- Replace the winch cable with one of the exact type.

VEHICLE MAINTENANCE

MAINTENANCE SAFETY



To prevent serious injury or death, follow the procedures and comply with the safety information in this manual while performing vehicle service or maintenance.

Use the tools shown in the tool list and wear the specified safety equipment when performing vehicle service or maintenance.

Remove all jewelry before you service the vehicle.

Do not allow loose clothing or hair to contact the moving parts.

Do not touch hot objects.

The drive wheels must be lifted and supported on jack stands before performing any service to the powertrain while the motor is in operation.

Chock the wheels and support the vehicle with jack stands. NEVER get under a vehicle that is supported by a jack alone. Lift the vehicle according to the manufacturers instructions.



When servicing the vehicle, always wear eye protection. Be careful when working around batteries, using solvents, or compressed air.

Use insulated tools within the battery area to prevent sparks or battery explosion.

Maintain constant awareness that some components are heavy, spring loaded, corrosive, explosive, can cause high amperage, or get extremely hot. Battery acid and hydrogen gas can cause bodily injury. Keep hands, face, feet and body away from any area that can expose them to injury if an unexpected situation occurs.

After performing maintenance, test the vehicle in a safe area that is free from vehicle and person traffic.

NOTICE: To decrease the risk of engine damage, do not operate the vehicle at full throttle for more than 5 seconds if the drive wheels are lifted off the ground.

SCHEDULED MAINTENANCE

Consistent inspection, adjustment, and lubrication of some components are necessary to maintain the *vehicle* so that it remains in safe and reliable condition. Refer to the *SCHEDULED MAINTENANCE CHART* on page 36 for detailed requirements.

Inspect, clean, lubricate, adjust, and replace parts as necessary. Use OEM or equivalent replacement parts.

Record the maintenance items performed along with details in the *MAINTENANCE LOG* beginning on page 57.

NOTICE: Service and adjustments are important for safe and reliable vehicle operation. If not familiar with safe service and adjustment procedures, have a certified dealer perform the operations.

Initial Service Requirements

Perform the additional inspection or maintenance at the initial service interval indicated, in addition to regular intervals. See *SCHEDULED MAINTENANCE CHART* on page 36. The initial service is required for optimum performance and reliability.

- engine oil and filter
- starter/generator belt

Severe Use Conditions

Vehicles subjected to heavy or severe use must be inspected and serviced more frequently than those of normal use patterns. The following conditions are considered severe use:

- frequent or prolonged use in a dusty environment
- frequent use in mud, water or sand
- prolonged low speed operation
- short trips in cold weather
- prolonged heavy load operation

MAINTENANCE

SCHEDULED MAINTENANCE CHART

Perform all services at the maintenance interval reached first.

S – Indicates operations that need to be performed on vehicles subjected to severe use.

E – Indicates emission-related services (Failure to do this maintenance will not void the emissions warranty but may affect emissions).

D – Indicates services that must be performed by an authorized dealer.

Item	Interval (perform at interval that comes first)		Remarks	Page
	Hours	Calendar		
Steering	Pre-ride		Check for smooth and free operation.	
Front suspension	Pre-ride		Inspect. Check for leaks and loose or missing hardware.	
Rear suspension	Pre-ride		Inspect. Check for leaks and loose or missing hardware.	
CV boots	Pre-ride		Inspect. Replace as needed.	
Tires	Pre-ride		Check condition and pressure.	11, 41
Wheel lug nuts	Pre-ride		Check for loose or missing.	41
Accelerator	Pre-ride		Check for smooth operation.	
Brake system	Pre-ride		Check for proper operation.	50
Frame hardware	Pre-ride		Check for loose or missing.	
Fuel and engine oil level	Pre-ride		Check for correct level.	38
Air filter	Pre-ride		Inspect. Clean as needed.	47
Headlights and taillights	Pre-ride		Check operation. Replace bulbs as needed.	42
Reverse warning alarm	Pre-ride		Check operation.	
Switches	Pre-ride		Check operation.	
Fluid leakages	Pre-ride		Inspect entire vehicle for leaks	
CVT belt	Pre-ride		Check condition.	
Engine oil and filter	Initial Service		Replace oil and filter at first 50 hours of operation.	43
Starter/generator belt	Initial Service		Check between first 15 and 20 hours.	
Wheels	Weekly		Check condition of rims, missing or loose lug nuts.	
S E Air filter	Weekly		Inspect. Clean as needed.	47
S Cooling fan	Weekly		Check for build-up of dirt inside blower housing and fins; clean as necessary.	
S Engine oil	Weekly		Check level; add as necessary.	
Starter/generator belt	Weekly		Check condition.	
S Brake pads	10	Monthly	Inspect. Replace as needed.	
Parking brake	20	Monthly	Conduct brake performance test; adjust as necessary	
Hydraulic brakes (if equipped)	Monthly		Check brake fluid.	
Controller	20	Monthly	Check operation of controller braking force.	
Wiring	20	Monthly	Inspect for loose connections, broken or missing insulation.	
Direction selector	20	Monthly	Inspect attachment and mechanism; adjust as necessary.	
Steering	20	Monthly	Check for excess play, loose or missing hardware.	
S Tie rods	20	Monthly	Check for excess play, bent rods, loose or missing hardware.	
Engine	20	Monthly	Check for unusual noise, vibration, acceleration, oil leaks.	
Rear axle	20	Monthly	Check for leakage; add oil as required.	

Item	Interval (perform at interval that comes first)		Remarks	Page	
	Hours	Calendar			
	Throttle/governor linkage	50	3 Months	Check operation and governed speed.	
E	Fuel system	50	3 Months	Check for leakage at tank, cap, lines, filters, pump, carburetor.	
	Front axle	50	3 Months	Check for damage, loose or missing hardware.	
	Parking brake	50	3 Months	Inspect linkage rods, latch arm, catch bracket. Lubricate with light oil (Do not lubricate cables or brake latch).	
S	Engine electrical system	50	3 Months	Check coil/spark plug wires for cracks or loose connections.	
S	Rear suspension	50	3 Months	Inspect shocks for leaks, worn bushings, loose or missing hardware.	
S	Front suspension	50	3 Months	Inspect strut for leaks. Check hubs and kingpins, for excessive play, worn bushings, loose or missing hardware.	
	Front wheel alignment	50	3 Months	Inspect for unusual tire wear; align if necessary.	
S	Battery	125	6 Months	Inspect terminals. Clean as needed.	51
	King pins	125	6 Months	Check for excessive play and tightness of retaining nuts.	
	Rear axle	125	6 Months	Check for unusual noise, loose or missing hardware.	
S E	Air filter	125	6 Months	Inspect; clean as necessary.	
	CVT belt	125	6 Months	Inspect for cracks, fraying and excessive wear.	
	Direction selector	125	6 Months	Check for wear and smooth movement; lubricate shaft with light oil if necessary.	
	Steering	125	6 Months	Inspect bellows and pinion seal for damage and leakage.	
	Rack end ball joint	125	6 Months	Check for noise and loose or missing hardware.	
S	Air Filter	250	Yearly	Replace.	
S	Oil filter	250	Yearly	Replace (with oil change).	
S	Engine oil	250	Yearly	Replace. See <i>RECOMMENDED LUBRICANTS AND FLUIDS</i> on page 38 for type and capacity.	38
S	Rear axle	250-300	Yearly	Check fluid level; add if required.	
S	Front wheel bearings	250-300	Yearly	Check and adjust as necessary.	
S	Brakes	250-300	Yearly	Clean and adjust. Check brake shoe linings; replace if necessary.	
S	Muffler/exhaust system	250-300	Yearly	Check hardware. Inspect for leaks at head and muffler gas-kets.	
	Valves - intake/exhaust	250-300	Yearly	Check cold.	
S E	Spark plug	250	Yearly	Replace and gap new.	47
	Cylinder head and piston	500	5 years	Remove carbon.	
	Cylinder head and piston	500	5 years	Check valve seats for carbon buildup; clean if necessary.	
	Rear axle	500	5 years	Replace fluid.	

MAINTENANCE

RECOMMENDED LUBRICANTS AND FLUIDS

Check and lubricate all components at the intervals shown in the *SCHEDULED MAINTENANCE CHART* beginning on page 36.

Item	Capacity	Lubricants/Fluids		Notes
Engine oil	1.3 qt. (1.25 L)	10W-30	Light duty use engines	See page 43.
		10W-30	Heavy duty use in air temperatures below 40° F (4° C)	
		10W-40	Heavy duty use in air temperatures above 40° F (4° C) after 100 hour break-in period	
Brake fluid	DOT 3			
Fuel	6.0 gal. (22.7 L)	Unleaded; 87 octane min 10% ethanol content max.		See page 22.
Rear axle oil	51 oz. (1.5 L)	MOBIL 424		
Rear axle friction modifier	2 oz. (60 ml)			
Grease fittings		Universal joint grease or equivalent		Do not exceed 3 pumps of grease in each fitting.

REPLACEMENT OF MAINTENANCE ITEMS

These items or their equivalents can be purchased through an authorized dealer, directly from the manufacturer or any other qualified source.

Item	Part Number
Oil Filter	607454
Air Filter	28463G01
Spark Plug (NGK BPR2ES)	607462
Starter/Generator Belt	26414G1
Clutch Belt	618630
15A Fuse	636455G13
5A Fuse	636455G10
10A Fuse	636455G12
20A Fuse	636455G14
Fuel Pump Relay	663593
Headlight Bulb	619100
Turn Signal Bulb	619102
Taillight Bulb	611242

LIFTING THE VEHICLE

WARNING

Read and comply with all of the following warnings and lifting procedures to prevent the possibility of the vehicle falling and causing serious injury or death.

For some maintenance procedures, it is necessary to lift the vehicle. Comply with the following warnings and follow the lifting procedure to ensure the safety of you, your vehicle and surroundings.

WARNING

The vehicle must be on a firm and level surface for lifting.

Remain constantly aware that the vehicle is not stable during the lifting process.

Place the jack and jack stands only in the areas indicated in the following illustration.

Do not get under a vehicle until it's stability on the jack stands is verified; never get under a vehicle while it is on a jack alone.

Put wheel chocks in front and behind all wheels that are not being lifted.

Do not allow anyone to remain or get on the vehicle at any time during the lifting process or when the vehicle is lifted.

When performing any service to the drive train, lift the drive wheels off the ground.

Tools

- jack
- jack stands (4)
- wheel chocks

Lifting Front

1. Chock the rear wheels to keep the vehicle from rolling backward.
2. Put a jack under the center of the front axle.
3. Raise the vehicle with the jack.
4. Install jack stands under the front frame cross member as shown.
5. Lower the vehicle until it rests on the jack stands.
6. Remove the jack.
7. Confirm that the vehicle is stable on the jack stands before proceeding with any service.

Lifting Rear

1. Chock the front wheels to keep the vehicle from rolling forward.
2. Put a jack under the center of the rear frame cross member.
3. Raise the vehicle with the jack.
4. Install jack stands under each end of the rear axle.
5. Lower the vehicle until it rests on the jack stands.
6. Remove the jack.
7. Confirm that the vehicle is stable on the jack stands before proceeding with any service.

Lowering Vehicle

1. Make sure chocks are still in place on any wheels that remain on the ground.
2. Put the jack in the same location that was used to raise the vehicle.
3. Raise the vehicle enough to remove the jack stands. Remove the jack stands from underneath the vehicle.
4. Slowly lower the vehicle to the ground and remove the jack.

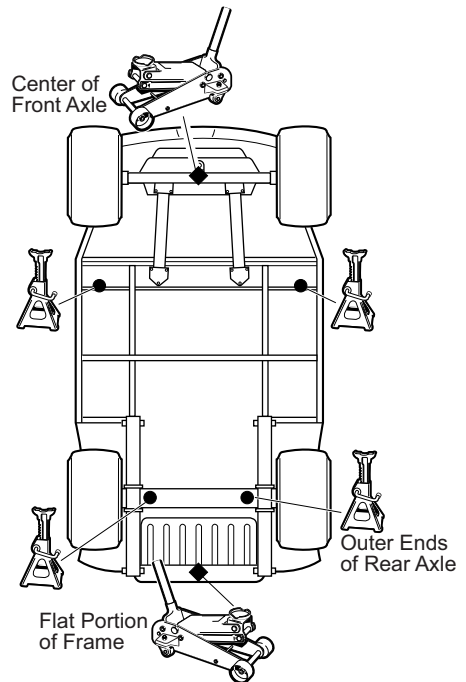

MAINTENANCE

VEHICLE CLEANING AND CARE

Keeping your vehicle clean is not only beneficial to its appearance, but can also help extend the life of various components.

Washing the Vehicle

NOTICE: Do not use a pressure washer to wash the vehicle. High water pressure can damage components.

Some products, including insect repellents and chemicals, will damage plastic surfaces. Do not allow these types of products to contact the vehicle.

- Do not use a pressure washer to clean the vehicle.
- Use an automotive type cleaner or mild soap to wash the vehicle. Harsh cleaners can scratch the finish.
- Use clean or new cloths and pads for washing. Reused cloths and pads can contain dirt particles that will scratch the finish.
- Inspect all grease fittings for dirt intrusion or lack of grease after washing. Apply grease as required to maintain proper function.
- Use a sponge or soft brush and a soap/water solution to clean the vinyl seats. Rinse with clean water.
- Use an automotive type wash cloth to wash the body of the vehicle. To prevent the soap from drying on the vehicle, rinse with clean water frequently.
- Clean the windshield with water and a clean cloth. Remove small scratches with a plastic polish.
- Clean the bottom of the vehicle where mud or dirt can collect. Loosen any packed sediment to help with removal. Be careful not to damage the paint.
- Dry the vehicle with a chamois before the water dries to prevent water spots.

Polishing the Vehicle

- Do not use medium to heavy duty compounds on the finish. Use wax that is for clear coat automotive finishes only. Do not apply wax or polish to matte finish surfaces.
- Use clean or new cloths and pads for polishing. Old or reused cloths and pads can contain dirt particles that will scratch the finish.

TIRES

Follow the tire maintenance procedures as instructed in this manual and on the labels on the vehicle.

Always use the approved size and type of replacement tires. See Vehicle Specifications for the proper tire type and size.

WARNING

Worn, improperly inflated, improper sized, or incorrectly installed tires will affect vehicle handling and could cause an accident resulting in severe injury or death.

Inflate all tires to the same pressure. Operating with unequal or incorrect pressure can adversely affect steering and handling and could cause an accident resulting in severe injury or death.

To decrease the risk of tire explosion, do not exceed the tire inflation rating on the tire sidewall. Make sure the tires are properly inflated at all times of operation. See *Tire Pressure* on page 11.

To decrease the risk of tire explosion, inflate small amounts of air into the tire at intervals to allow the bead to seat properly. Because of the low volume of the small tires, over inflation can occur in seconds. Never exceed the tire inflation pressure rating on the tire sidewall when seating a bead. Protect your face and eyes when you remove a valve core.

When you remove the wheels, use only sockets made for impact wrenches to decrease the risk of injury by a broken socket.

Do not use tires with a low rated pressure. Do not use tires that have a recommended tire inflation pressure less than the tire inflation pressure recommended in the owner's manual.

Do not over inflate the tires. Excess pressure can cause the tire to separate from the wheel or cause a tire explosion.

Tire Pressure

Maintaining correct tire inflation pressure is essential for safe vehicle operation. You can vary the inflation pressure, within the recommended range to suit the condition of the terrain.

TIRE PRESSURE RANGE	TERRAIN CONDITIONS	RECOMMENDATION
18 - 22 psi (124 - 152 kPa)	hard surfaces or pavement	Inflate to higher pressure within the range; never exceed maximum pressure indicated.
	soft terrain or turf	Inflate to lower pressure within the range to reduce potential damage to the terrain or turf.

Tire Repair

Tools

- lug wrench, 3/4"
- impact socket, 3/4"
- impact wrench
- torque wrench, ft.lbs.

NOTICE: Tire plug tools and plugs are available at automotive outlets. The tire does not have to be removed from the wheel to install the tire plug.

Use a tire plug to repair small holes in the tread part of the tire. For large holes or holes/cuts in the tire sidewall, the tire must be replaced.

1. Remove the wheel from the vehicle. See *Wheel Removal* on page 41.
2. Locate the leak in the tire.
 - a. If the tire is very low or flat, fully inflate the tire.
 - b. Brush soapy water over the surface of the tire. Air bubbles will be visible where the air is leaking from the tire.
 - c. Mark the hole with chalk.
3. Install the plug according to the manufacturer's instructions.
4. Install the wheel on the vehicle. See *Wheel Installation* on page 42.
5. Fully inflate the tire. See *Tire Pressure* on page 11.

Tire Replacement

Tire replacement requires a tire mounting machine, and must be done by a qualified tire center or an authorized dealer.

WHEELS

WARNING Worn, improperly inflated, improper sized, or incorrectly installed tires will affect vehicle handling and could cause an accident resulting in severe injury or death.

CAUTION To decrease the risk of component damage, do not tighten the lug nuts to more than the torque specified below.

Check the lug nuts for tightness at the intervals indicated in the *SCHEDULED MAINTENANCE CHART* on page 36.

Wheel Removal

Tools

- lug wrench, 3/4"
- impact socket, 3/4"
- impact wrench
- torque wrench, ft.lbs.

1. Lift the vehicle. See *LIFTING THE VEHICLE* on page 39.
2. Remove the lug nuts.
3. Remove the tire from the vehicle.

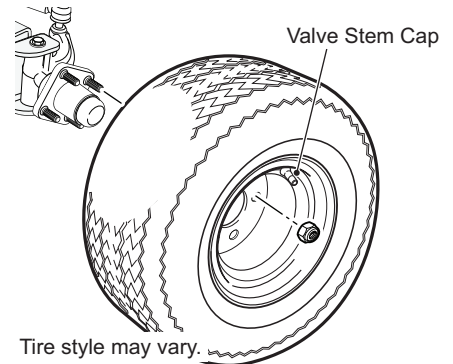

MAINTENANCE

Wheel Installation

NOTICE: To decrease the risk of component damage, do not tighten the lug nuts to more than the specified torque.

Always install lug nuts using a cross sequence pattern to ensure the even seating of the wheel against the hub.

1. Install the wheel on the hub with lug nuts. Make sure the valve stem is to the outside.
2. Finger tighten the lug nuts.
3. Using the cross tightening pattern shown to the right, tighten the lug nuts to 65 - 85 ft.lbs. (88 - 115 Nm). Tighten in increments of 20 ft. lbs. (27 Nm).

Lug Nut Tightening Pattern

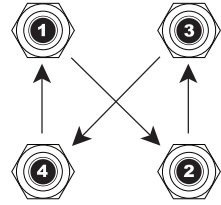

Lug Nut Torque	65 - 85 ft.lbs. (88 - 115 Nm)
----------------	-------------------------------

LIGHTS

- Clean the lights frequently to maximize visibility.
- Replace burned out bulbs promptly.

CAUTION

Do not operate this vehicle at night or in low light if any bulbs are burned out. Poor lighting reduces visibility that could cause an accident resulting in severe injury or death.

NOTICE: Replacement bulbs are available from a local Distributor, an authorized Branch or the Service Parts Department.

Halogen Headlight Bulb Replacement

CAUTION

Light components can get hot if they have been in operation. Allow the lights to cool before servicing to prevent burns to the skin.

NOTICE: Do not touch a halogen bulb with bare fingers. Oil from skin leaves a residue that causes a hot spot and will diminish the life of the bulb.

1. Disconnect the headlight harness from the headlight.
2. Rotate the bulb 1/4-turn to remove the headlight bulb from the housing.
3. Insert and rotate the new bulb to lock into place.
4. Connect the harness to the bulb.

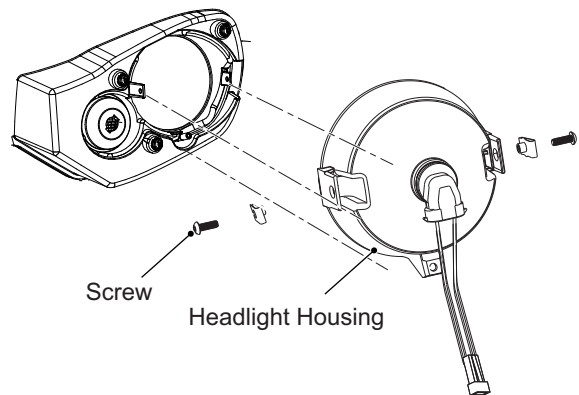

Taillight

1. Roll the rubber bezel from around the edge of the taillight and remove the lens.
2. Install the new bulb.
3. Replace the lens.

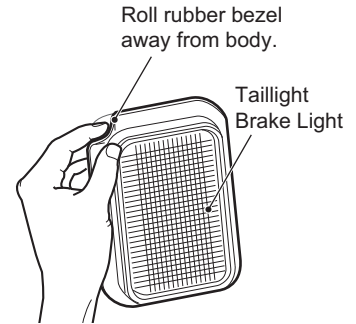

FUSE REPLACEMENT

The fuse block is under the driver seat.

NOTICE: Have the vehicle inspected by an authorized dealer if fuses continue to blow after they have been replaced.

1. Lift the seat bottom to access the fuses.
2. Remove the old fuse and replace with a new fuse of the same type and size.
3. Fuses are available from a local Distributor, an authorized Branch, or the Service Parts Department.

FOUR CYCLE ENGINE

The engine is an air cooled, 4-stroke, OHV, single cylinder gasoline engine. It has a pressure fed lubrication positive displacement oil pump with a cartridge type full flow oil filter and a counter rotating balance shaft.

NOTICE: The engine uses more oil during the first hours of operation, than after the internal parts are run-in. As the run-in process occurs, oil use will gradually decrease until it stabilizes.

Engine Specifications

Engine Model	EFIA-1
Type.....	Four cycle, OHV
Number of Cylinders.....	1
Displacement.....	401 cc
Rated Horsepower	13.5 hp
Spark Plug Type	NGK BPR2ES
Spark Plug Gap028"
031" (.70 - 80 mm)	
Cooling	Forced Air Cooled
Oil Filter	Cartridge Type Full Flow Filter
Oil Pump.....	Positive Displacement Pump

CHECK THE OIL LEVEL

Check the engine oil at the intervals indicated in the *SCHEDULED MAINTENANCE CHART* on page 36.

Tools

- funnel
- clean lint-free cloth



Wear protective gloves to prevent scalding from hot engine oil.

Check the engine oil level when the engine is warm and the vehicle parked on level surface.

1. Turn key switch to the OFF position and engage the parking brake.
2. Allow oil to drain into crankcase.
3. Wipe the top of the engine clean with a cloth to remove debris that could fall in the engine.
4. Remove the dipstick and wipe off the entire length with a clean lint-free cloth.
5. To get an accurate level reading, wipe oil from the dipstick and insert back into the opening.
6. Remove the dipstick again and check the level. The oil level must be in the area between L and H (in the cross-hatch) on the dipstick.

MAINTENANCE

- The engine can be operated safely as long as oil is within the safe operating range as indicated on the dipstick.

NOTICE: *The lack of oil or low oil level can damage the engine. Do not operate vehicle if oil level is below the safe area indicated on the dipstick.*

- If the oil level is below the L line, add engine oil into the dipstick hole until the level is between L and H.

NOTICE: *Excessive oil can damage the engine. Oil expands as it gets hot, so do not overfill.*

- If the oil level is above the H line, pump out the excessive oil with a siphon pump.
- Replace the dipstick.

NOTICE: *The oil dipstick/fill cap must be in place before operating the engine. Failure to install the dipstick/fill cap will result in oil contamination or oil being discharged into the engine compartment.*

See RECOMMENDED LUBRICANTS AND FLUIDS on page 38 for oil capacity and grade. The use of an incorrect grade of engine oil can damage the engine. Always use the recommended grade. Do not mix engine oils of different grades or viscosity.

Do not overfill. Excessive oil can damage the engine. Add oil in small quantities with repeated level checks.

- When the level is correct, replace the dipstick.

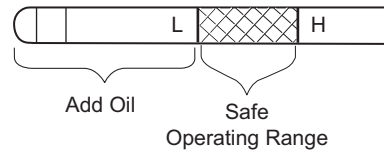

CHANGE THE ENGINE OIL

Change the engine oil at the initial service and then intervals indicated in the *SCHEDULED MAINTENANCE CHART* on page 36.

Tools

- ratchet
- socket, 19 mm
- Extension, 8"
- universal strap wrench
- funnel
- drain pan

NOTICE: *See RECOMMENDED LUBRICANTS AND FLUIDS on page 38 for oil capacity and grade. The use of an incorrect grade of engine oil can damage the engine. Always use the recommended grade. Do not mix engine oils of different grades or viscosity.*

Do not overfill the oil tank. Excessive oil can damage the engine. Add oil in small quantities with repeated level checks.

If vehicle is to be stored over winter months, it can be stored with old oil left in engine. The oil should be changed as part of spring maintenance to remove any moisture that has accumulated during storage.

Remove the Engine Oil



Wear protective gloves to prevent scalding from hot engine oil.

Change the engine oil when the engine is warm and the vehicle is parked on a level surface.

- Turn the key to OFF and engage the parking brake.
- Wipe the top of the engine clean with a cloth to remove debris that could fall in the engine.
- Remove the oil fill cap.
- Place a drain pan under the oil drain plug at the rear of the engine base.

- Remove the drain plug and allow the oil to completely drain into the pan.

NOTICE: *At the first oil change, small metal chips and lint may be found. This is normal, resulting from the break-in period. Inspect the filter at every oil change. The presence of large metal chips could indicate possible damage to the engine.*

- Before installing the drain plug, clean the area around the drain hole with a lint free cloth
- Inspect the drain plug and o-ring for damage; replace if necessary.
- Tighten the drain plug to 62 in. lbs. (7 Nm) torque.



Change the Oil Filter

- Clean the area around filter.
- Place a drain pan below the oil filter.
- Remove the filter from the engine and allow the oil to drain.
- If the filter o-ring remains on the engine surface, remove it and discard it along with the filter (7).
- Inspect the new oil filter for any defects.
- Apply engine oil to the oil filter o-ring (5).
- Install the oil filter onto the engine until the o-ring contacts the mounting surface of the engine. Turn the filter 2/3 to 3/4 rotations by HAND(S).

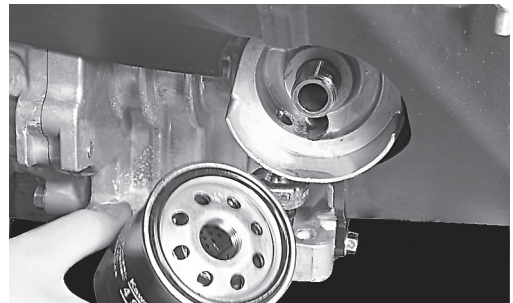
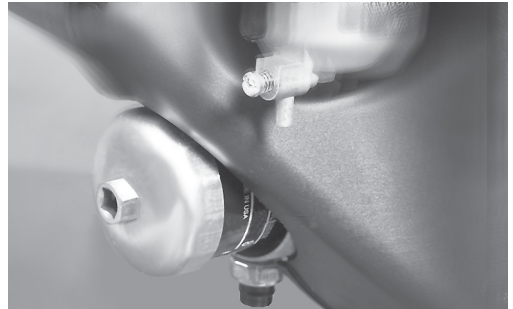

Refill Oil

NOTICE: *See RECOMMENDED LUBRICANTS AND FLUIDS on page 38 for oil capacity and grade. The use of an incorrect grade of engine oil can damage the engine. Always use the recommended grade. Do not mix engine oils of different grades or viscosity.*

Engine oil must be high quality oil that meets or exceeds API SF, SG, CC standards.

Do not overfill. Excessive oil can damage the engine. Add oil in small quantities with repeated level checks.

- To allow for possible residual oil left in the engine, add slightly less than the rated engine capacity (**RECOMMENDED LUBRICANTS AND FLUIDS** on page 38) into the fill hole.
- Check the oil level on the dipstick. The oil should be slightly below the H level and within the crosshatch to allow for expansion.
- Add oil in small quantities with repeated level checks to make sure you are not overfilling the engine.
- When the level is correct, replace the dipstick.
- As a final check, check the oil level again with the vehicle on level ground.

Oil increases in volume when warm. The H mark on the dipstick is calibrated for an engine at operating temperature. When the engine is cold, the oil will be below the full mark. The engine can be operated safely as long as the oil is within the safe operating range as indicated on the dipstick. **Do not operate the vehicle if the oil level is below the safe area indicated on the dipstick.**

MAINTENANCE

STARTER/GENERATOR BELT

Check the starter/generator belt at the initial service and then intervals indicated in the *SCHEDULED MAINTENANCE CHART* on page 36.

Tools

- Belt Tension Gauge
- Wrench, 3/4"
- Wrench, 9/16"
- Ratchet
- Socket, 3/4"

CAUTION

Never allow the tension to exceed 160 lbs (73 kg) while installing the belt.

At the time of installation, the belt must not be rolled over the installed edges of the starter/generator or drive clutch pulleys. Excessive stretch in the belt can cause cord failure.

NOTICE: A loose belt can cause audible vibration and squeal.

1. New belt:
 - a. Tighten a new starter/generator belt to 25 - 30 lbs. (110 - 130 N) tension when a gauge is applied half way between the two pulleys.
 - b. A new belt may be checked manually. A maximum deflection of 3/8" (10 mm) is acceptable.
2. Existing belt:
 - a. Tighten an existing belt to 17 - 18 lbs. (75 - 80 N) tension using the same technique.
 - b. Inspect for cracks or wear. A maximum deflection of 1/2" (13 mm) is acceptable.

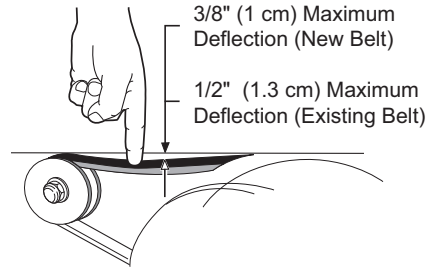

Adjusting the Belt

1. Loosen the starter/generator pivot bolt.
2. While holding the lower adjusting nut with a wrench, loosen the upper jam nut with another wrench. Move the lower nut up or down the adjustment bolt until the correct belt tension is achieved.
3. Hold the lower nut in place and tighten the upper jam nut against it.
4. Tighten the starter/generator pivot bolt.

AIR INTAKE AND COOLING FINS

WARNING

Keep the engine cooling components clean to reduce the risk of overheating and the possible ignition of accumulated debris.

Dirt and debris can clog the engine air cooling system. Allow the engine to cool and use the following guidelines after every off-road use:

- Check for a build up of dirt and debris in the air intake and cooling fins.
- Clean the areas shown to prevent engine damage.
- Make sure the linkages, springs and controls are clean.
- Make sure the area around the muffler is free of any combustible material.

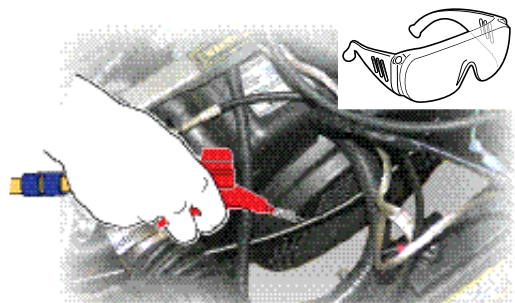

Regular maintenance of the cooling system is required to ensure an adequate supply of air to the cooling fins. Compressed air can be used for routine cooling system maintenance.

Clean the cooling system at the intervals indicated in the *SCHEDULED MAINTENANCE CHART* on page 36.

REAR AXLE

The rear axle has an oil level check/fill plug located on the driver side at the rear of the housing. Unless leakage of axle oil is evident, an annual check is sufficient.

Change the axle oil at the intervals indicated in the *SCHEDULED MAINTENANCE CHART* on page 36. The drain plug is located at the bottom of the rear axle housing.

Checking the Axle Oil Level

Tools

- Socket, 13 mm
- Ratchet
- Funnel

1. Clean the area around the check/fill plug.
2. Remove the plug. The correct axle oil level is **just** below the bottom of the threaded hole.
3. If axle oil is low, slowly add oil with a pump until it starts to seep from the check/fill hole. Install the plug.

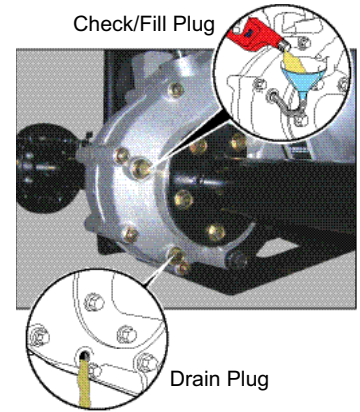

AIR FILTER

Inspect and replace the air filter cartridge at the intervals indicated in the *SCHEDULED MAINTENANCE CHART* on page 36.

NOTICE: *The filter is a dry filter. Do not apply oil.*

1. Unlatch the cover to access the air filter cartridge.
2. Remove the filter from the housing.
3. Inspect the cartridge.

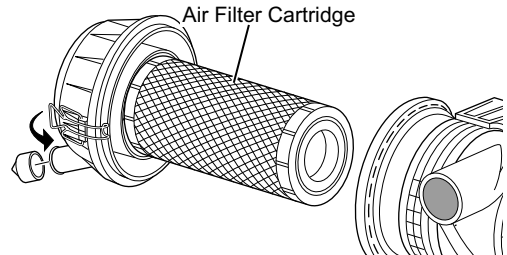

CAUTION

Using compressed air to clean the filter cartridge will damage the filter which can cause engine damage.

4. A lightly soiled filter can be cleaned by tapping out dust. Do not use compressed air on the filter. If the filter is heavily soiled, it must be replaced.
5. Reinstall or replace the filter, making sure it is fully seated in the housing.
6. Replace the housing and secure with the latches on the air cleaner cover.

SPARK PLUG

Tools

- spark plug socket, 13/16"
- ratchet
- anti-seize compound
- torque wrench, ft. lbs
- feeler gauge

CAUTION

Do not over tighten the spark plug. Over tightening the plug can cause damage to the aluminum cylinder head threads.

1. Remove the spark plug when the engine is cold.
2. Inspect and replace the spark plug at the intervals indicated in the *SCHEDULED MAINTENANCE CHART* on page 36.

MAINTENANCE

INSPECT	CONDITION OF SPARK PLUG	ACTION
Electrode	Sooty	Clean carefully with a wire brush.
	Worn or damaged	Replace spark plug.
Condition of plug	Fouled (indicated by a wet, black appearance) possibly caused by:	
	• dirty air filter element or other restrictions in the air intake system	Clean air system. Replace spark plug.
	• incorrectly adjusted valves	Adjust valves. Replace spark plug.
	• park plug wire in poor condition	Repair or replace wire. Replace spark plug.
	• poor fuel quality	Change fuel. Replace spark plug.
Porcelain insulator	Visible cracks	Replace spark plug.
Gap	Correct gap (see illustration at right)	Reinstall spark plug.
	Incorrect gap (see illustration at right)	Adjust to correct measurement.

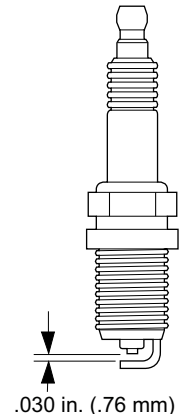

3. Apply a light coat of anti-seize compound to the spark plug threads.
4. Tighten to 16 ft. lbs. (22 Nm) torque.

MALFUNCTION INDICATOR LIGHT (MIL)

The EFI system uses Diagnostic Trouble Codes to report issues. Both active and stored faults are reported by the Engine Control Module (ECM).

- Active Faults – These are faults that have been triggered since the key switch was last turned to the ON position.
- Stored Faults – These are faults that are no longer active. These faults have not been triggered since the key switch was last turned to the ON position. They were active at one time but were stored when the key switch was turned to the OFF position sometime in the past.

These faults can be read from the MIL located on the rear of the vehicle's seat frame. The MIL can be viewed through the opening between the rear of the center console and the refresher unit. A series of flashes indicates each fault code. A description of how to read codes from the MIL is detailed below. More information about each fault can be obtained from a service technician with the proper equipment.

Follow the below procedure to read active and stored vehicle faults from the MIL:

1. Lock the vehicle's direction selector in Neutral.
2. View the MIL by lifting the truck bed.
3. Turn the key switch to the ON position
4. Observe the sequence of flashes. Each code is separated by five seconds of solid illumination.
 - a. Single-digit fault codes display as a sequence of one-second flashes, with the number of flashes matching the code value (e.g. 8 flashes for MIL code 8).
 - b. Double-digit fault codes display as a combination of 0.3-second flashes for the tens place and 1-second flashes for the ones place.
 - c. Active faults are displayed first, then stored faults are displayed.
 - d. Active faults are displayed whether the engine is running or not. Stored faults only display when the engine is not running.

If there are no active or stored faults, the MIL will illuminate continuously (no flashes) to demonstrate functionality.

The ECM will enter sleep mode after 60 minutes of inactivity. If the key switch is in the ON position and the MIL is not illuminated, press and release the accelerator pedal to wake the system and reveal any active fault codes.

MIL Flash Code	Fault	Recovery Steps
1	Temp Sensor Disconnected / Failure	<ol style="list-style-type: none">1. Check that the sensor is connected.2. If connected, contact an authorized service rep.
2	Throttle Position Sensor Failure	<ol style="list-style-type: none">1. Contact an authorized service rep.
4	O ₂ Sensor Disconnected / Failure	<ol style="list-style-type: none">1. Check that the sensor is connected.2. If connected, contact an authorized service rep.
5	High Battery Voltage	<ol style="list-style-type: none">1. Verify battery voltage is between 10-16 VDC.2. If voltage is over 16 VDC, contact an authorized service rep.
5	Low Battery Voltage	<ol style="list-style-type: none">1. Verify battery voltage is between 10-16 VDC.2. If the voltage is below 10 VDC, replace the battery.3. If the fault persists, contact an authorized service rep.
SOLID	Safeties Active	<ol style="list-style-type: none">1. Press and release the accelerator pedal.2. If the fault is still present while the accelerator pedal is pressed, contact an authorized service rep.
8	Engine Running Rich / Lean	<ol style="list-style-type: none">1. Verify that the air filter is not clogged.2. If the fault persists, contact an authorized service rep.
22	Limp Home	<ol style="list-style-type: none">1. Contact an authorized service rep.

MAINTENANCE

BRAKES

WARNING

Always inspect the pedal travel before operating a vehicle to confirm some brake function is present.

All driving brake tests must be done in a safe location with regard for the safety of all personnel.

NOTICE: Over time, a subtle loss of performance may take place. It is, therefore, important to establish the standard with a new vehicle.

Test and service the brake system at the intervals indicated in the *SCHEDULED MAINTENANCE CHART* on page 36.

Periodic Brake Test

The *Periodic Brake Test* must be performed initially and regularly as an evaluation of your vehicle's brake system performance. It is a method of identifying a subtle loss of braking performance over time.

Establish the 'acceptable stopping distance' when your vehicle is new and the brakes are at their peak of performance. As your vehicle is used, a subtle loss of braking performance may be detected, so it is important to establish the standard with a new vehicle.

Actual stopping distances are influenced by weather conditions, terrain, road surface condition, vehicle weight and speed. No specific braking distance can be reliably specified, so it is important to establish a base to test with.

The test is conducted by engaging the park brake instead of the brake pedal to eliminate different pedal pressures, to include affects of linkage mis-adjustment and provide a more accurate test.

NOTICE: You must have enough space to accelerate to maximum speed before engaging the parking brake. Use a marker to indicate the predetermined line to engage the parking brake that you will use for the performance test.

1. On a dry, level, clean, paved surface, accelerate the vehicle to maximum speed.
2. Engage the parking brake at the predetermined and marked line.
3. Mark the line where the vehicle comes to a complete stop.
4. If the vehicle stops in a significantly greater distance than the established distance in future tests, or pulls to one side, it should be tested again.
5. If the vehicle fails the second test, discontinue use until it can be inspected and determined safe for operation by a qualified mechanic.

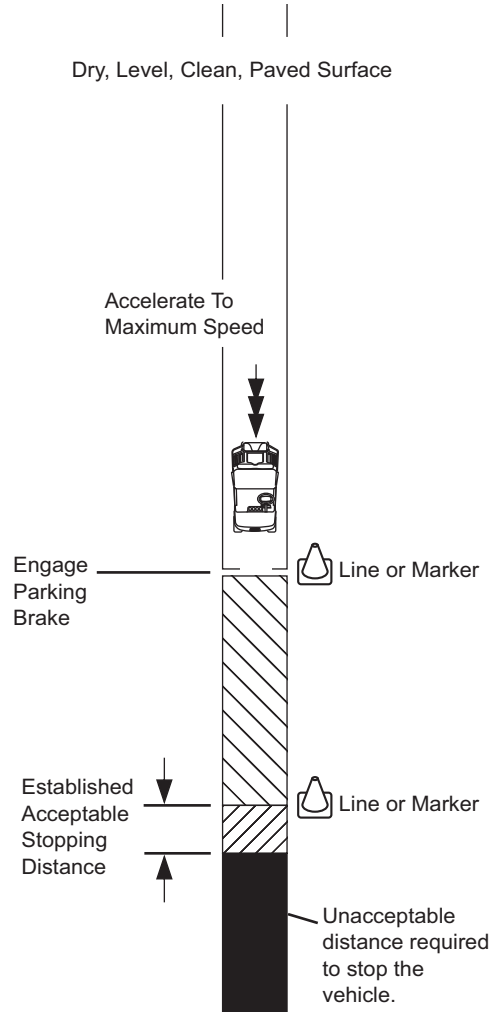

BATTERY

The vehicle has a sealed battery, which requires no maintenance except to keep it corrosion-free, and to test for functionality.

The sealed battery is filled with electrolyte and sealed at the factory. Never pry the seal strip off, or add fluid to the battery.

Inspect the battery terminals at the intervals indicated in the *SCHEDULED MAINTENANCE CHART* on page 36. Clean and tighten as needed.



WARNING

Use insulated wrenches to prevent direct contact of a wrench with the battery terminals. Direct contact of a bare wrench with battery terminals can cause an explosion resulting in severe injury or death.

To prevent the risk of battery explosion, keep all flammable materials, open flames or sparks away from the batteries.



CAUTION

The electrolyte in a battery is an acid solution which can cause burns to the skin and eyes. Completely clean all electrolyte spills that contact the body and eyes with clear water. Contact a physician immediately.

Neutralize electrolyte spills with a solution of 2 teaspoons (10 ml) sodium bicarbonate (baking soda) mixed in 1 quart (1 liter) of water. Clean with water.

Battery Cleaning



CAUTION

To decrease the risk of damage to the vehicle or floor, neutralize any acid before you spray the battery with water.

Always wear eye protection when cleaning the battery.

NOTICE: To decrease the risk of damage to the electrical components surrounding the battery while cleaning, do not use a pressure washer.

1. Remove corrosion with a wire brush.
2. Wash the top and sides of the battery with a solution of:
 - 1 tsp. (5 ml) baking soda
 - 1 cup (236 ml) water

Wash all metal components near the battery.

3. Rinse with tap water and dry with shop towels.
4. After the battery is clean and dry, coat with a commercially available battery terminal spray.

Battery Charging



WARNING

Hydrogen gas is produced as batteries are charged. Charge batteries only in well-ventilated areas.

Do not overcharge the battery. Overcharging the battery can cause overheating and possible explosion, resulting in severe injury or death.

NOTICE: Use a battery charger that is designed for charging sealed batteries.

Keep battery fully charged.

Heavy use of accessories can drain the battery and leave insufficient charge to start the vehicle.

The sealed battery is a 12 V starter battery that supplies power to the starter and accessories. A starter starts the engine and an internal generator charges the battery while the engine is running. Due to heavy use of accessories, the battery can become discharged even if the engine is running and the generator is operating.

It is important to keep the battery fully charged. Since the battery is sealed, a voltmeter or multimeter is required to check voltage.

1. Check the battery voltage with a voltmeter or multimeter.
 - If the voltage measured is 12.8 V or higher, the battery is fully charged and requires no further action.
 - If the voltage measured is less than 12.8 V, recharge the battery.
2. Charge the battery with a charger designed for sealed batteries. Follow the instructions supplied from the manufacturer of the charger.

MAINTENANCE

Discharged Battery

⚠ WARNING To decrease the risk of severe injury or death from accidental movement, do not use jumper cables to start a vehicle.

The vehicle has a starter/generator and does not idle. When you start the engine, the starter/generator functions as a starter and with the engine running, it functions as a generator.

The generator can keep the battery charged with short run times, but the generator will not charge a discharged battery.

When the engine starts, the clutches engage and cause the vehicle to move making jump starting both dangerous and impractical.

If the battery has discharged, charge it with a 12-volt charger that is rated at 10 amps or less and according to the instructions supplied by the manufacturer of the charger.

Battery Disposal

Return used batteries to the manufacturer or lead smelter for recycling purposes. For neutralized spills, put any residue in acid-resistant containers with absorbent material such as sand. Dispose in accordance with state and federal regulations for acid and lead compounds. Contact authorized environmental agencies for information about disposal.

Battery Storage

NOTICE: A battery will self-discharge over time. The rate of discharge varies depending on the ambient temperature, age, and condition of the battery. Check the battery each month during storage and charge as needed to maintain a full charge.

A full charge will prevent the battery from freezing in winter conditions.

If the vehicle is going to be out of operation for three (3) months or longer, do the following:

1. Remove the battery from the vehicle.
2. Make sure the battery is fully charged.
3. Store it out of the sun, in a cool, dry place.
4. Check the battery voltage each month during storage and recharge as needed to maintain a full charge.

TRANSPORTING THE VEHICLE

⚠ WARNING Do not ride or allow other people on a vehicle being transported on a trailer or being towed with another vehicle.

Hauling the Vehicle

⚠ WARNING Loose cargo or vehicle components can fly off when the vehicle is being transported. Secure or remove all cargo. Inspect the vehicle for loose components prior to transport.

Do not allow anyone to ride in a vehicle being transported on a trailer.

Remove the windshield and top before you transport a vehicle on a trailer.

- If the vehicle is being hauled on a trailer or truck, the canopy top and windshield must be removed.
- The rated capacity of the hauling trailer or truck must be more than the weight of the vehicle and load plus 1000 lbs. (454 kg). See *SPECIFICATIONS* for the weight of the vehicle.

1. Drive the vehicle onto the trailer or truck.
2. Engage the parking brake. Leave the direction selector in F (forward).
3. Turn the key to the OFF position.
4. To prevent loss of the key, remove it from the ignition switch.
5. Make sure the seat(s) are secured.
6. Secure the vehicle to the trailer or truck with tie downs, straps or ropes.

Towing the Vehicle

⚠ WARNING

Only tow the vehicle for recovery purposes. Ensure brakes and steering are operable. Always have a person driving the vehicle to steer and operate brakes when it is being towed.

Do not tow the vehicle above 5 mph (8 kph).

Failure to abide by these instructions could cause harm to vehicle and persons involved.

1. Turn the key switch to OFF.

NOTICE: *The direction selector has a neutral lock to prevent the driven clutch from turning the rear wheels when the vehicle is being towed by another vehicle*

2. Lock the direction selector with the neutral lock to ensure the direction selector remains locked in the neutral position.
 - a. Lift the seat to access the neutral lock.
 - b. Pull out and rotate the neutral lock pin handle so that the pointed portion of the handle is to the side of the direction selector cam.
 - c. Move the direction selector toward the area between F and R. During that motion the pin will snap into the hole in the direction selector mounting bracket, preventing movement.

When in this position, the direction selector remains locked in the neutral position.
3. Attach the vehicle to the towing vehicle with a tow bar that is approved by the manufacturer.
4. Release the parking brake if it is engaged.
5. After the vehicle has been towed, unlock the direction selector.
 - a. Pull the neutral lock pin handle out.
 - b. Rotate until the pointed portion of the handle fits into the hole in the direction selector cam.

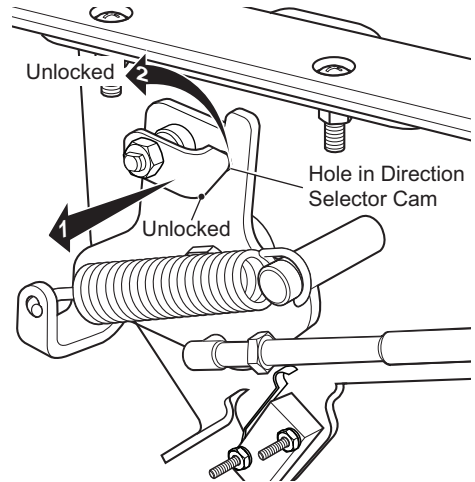

MAINTENANCE

VEHICLE STORAGE

Storing a vehicle for 30 days or more requires proper preparation to prevent a build-up of varnish and gum in the fuel system, and corrosion in the engine. The following procedure will prepare the vehicle for storage:

Store your vehicle in an area that is well ventilated. Cover the vehicle. Covers designed specifically for vehicles are recommended because they allow enough ventilation to prevent condensation and corrosion.

WARNING

Store the vehicle in a clean, dry area. Do not store in an area with a stove, furnace, water heater, or other appliance that uses a pilot light, or has a device that can create a spark.

Do not handle fuel in an area that is not adequately ventilated. Do not smoke near the fuel tank or refuel near open flame or electrical items which could produce a spark.

When refueling, inspect the fuel cap for leaks or breaks that could result in fuel spillage.

Always wear safety glasses while refueling to prevent possible eye injury from gasoline or gasoline vapor.

Keep hands, clothing and jewelry away from moving parts. Use caution not to contact hot objects. Raise the rear of the vehicle and support on jack stands before attempting to run the engine.

NOTICE: *The vehicle can be stored with the old oil left in the engine. The oil must be changed when the vehicle is removed from storage, before resuming operation. This removes condensation that may have accumulated in the crankcase.*

Do not leave the parking brake engaged during the storage period. Use wheel chocks to prevent the vehicle from rolling.

1. Clean the vehicle. See *VEHICLE CLEANING AND CARE* on page 40.
2. Turn the key switch to the OFF position and put the direction selector in the NEUTRAL position.
3. Chock the wheels to prevent the vehicle from rolling. Do not engage the parking brake.
4. Perform all required routine maintenance indicated in the *SCHEDULED MAINTENANCE CHART* on page 36.
5. Fully inflate the tires. See *Tire Pressure* on page 41.
6. Add fuel stabilizer (4 oz. for a full tank of fuel) to the fuel and install the cap securely.
7. Remove the spark plug and pour approximately 1/2 oz. (15 ml) of SAE 10 - 30 weight oil or fogging oil into the cylinder.
8. Rotate the crankshaft by hand several times, and reinstall the spark plug.

Remove from Storage

1. Change the oil.
2. Check the spark plug for tightness. Tighten if necessary.
3. Check all items in the daily pre-ride inspection. See *PRE-RIDE INSPECTION* on page 21.
4. Lubricate according to the *SCHEDULED MAINTENANCE CHART* on page 36.

SPECIFICATIONS

OX 400 - VEHICLE SPECIFICATIONS

Item	Specification
Overall Length	119.0 in (302 cm)
Overall Width	51.5 in (131 cm)
Overall Height (No Canopy)	53.0 in (135 cm) (Top of steering wheel)
Overall Height (With Canopy)	77.0 in (196 cm)
Wheel Base	77.5 in (197 cm)
Front Wheel Track	44 in (112 cm)
Rear Wheel Track	46 in (117 cm)
Ground Clearance (at Differential)	7.0 in (18 cm)
Turning Radius	11.8 ft (3.6 m)
Cargo Box Width (inside)	44.0 in (112 cm)
Cargo Box Length (inside)	39.0 in (99 cm)
Cargo Box Depth (inside)	12 in (31 cm)
Cargo Box Capacity	12 ft ³ (0.34 m ³)
Cargo Box Material	Roto-molded Polyethylene
Engine	Walbro 4-Cycle 24.5 in ³ (401 cc)
Valvetrain	Single Cylinder OHV
Horsepower (kW)	13.5 hp (10.1 kW) Exceeds SAE J1940 Standard
Cooling System	Air Cooled
Balancer	Internal Counter Rotating Balance Shaft
Ignition	Electronic Inductive Spark / Magneto
Electrical System	Starter / Generator. Solid State Regulator
Battery	12-Volt Maintenance-Free (525 CCA, 85 minute reserve)
Key or Pedal Start	Pedal
Air Cleaner	Replaceable Dry Cartridge
Lubrication	Pressurized Oil System
Oil Filter	Spin-On
Fuel System	Closed-loop electronic fuel injection
Max Fuel Volume	6.65 Gallon (25 L)
Fuel Pump Operating Pressure	43.5 psi (3 bar)
Drivetrain	Automatic, Continuously Variable Transmission (CVT)
Transaxle	Differential with helical gears
Gear Selection	Forward - Reverse
Rear Axle Ratio	11.47:1 (Forward) 14.35:1 (Reverse)
Seating Capacity	2-Person
Dry Weight	1052 lb (477 kg)(without battery)
Curb Weight	1092 lb (495 kg)
Bed Load Capacity	500 lb (227 kg)
Vehicle Load Capacity	900 lb (408 kg)
Outside Clearance Circle	23.5 ft (7.2 m)

SPECIFICATIONS

Speed (Level Ground)	16.5 mph \pm 0.5 mph (26.58 kph \pm 0.80 kph)
Maximum Drawbar	500 lbs (2225 N)
Towing Capacity	1200 lbs (544 kg) max load
Steering	Self-compensating reduction rack and pinion
Front Suspension	Leaf springs with hydraulic shock absorbers
Rear Suspension	Leaf springs with hydraulic shock absorbers
Brakes	Dual rear wheel mechanical self-adjusting drum
Parking Brake	Self-compensating, single point engagement
Front and Rear Tires	Desert Eagle 23 x 10 - 12 (4 ply rated)
Frame	Welded steel with DuraShield™ powder coat
Front Body and Finish	Injection Molded TPO
Rear Body and Finish	Injection Molded TPO
Noise	Sound pressure; continued A-weighted equal to or less than 74 db(A)
Vibration, WBV	Highest RMS value of weighted acceleration is less than 2.5 m/s ² .
Vibration, HAV	Highest RMS value of weighted acceleration is less than 2.5 m/s ² .
	The uncertainty of measurement is 0.54 m/s ² .
	Measurement methods were applied per the ISO 2631 and ISO 5349 standards under conditions of typical vehicle surfaces.
<i>Some items shown may be optional equipment</i>	

INDEX

A

accelerator pedal 18
auxiliary outlet, 12V 17

B

battery disposal 8
battery maintenance 58
brakes 58
 pedal, hydraulic 18
 pedal, mechanical 18
break-in
 CVT belt 22
 engine 22

C

cable, winch 30
capacity
 cargo load 11
 fluids 46, 63
 hitch 63
 load 63
 towing 63
carbon monoxide 13
cargo
 maximum load 11
choke 19
cleaning the vehicle 48
cup holder 17
CVT belt break-in 22

D

direction selector 19
driving procedures
 accelerating 23
 braking 24
 downhill 25
 parking 26
 passenger 24
 reverse 26
 slippery surfaces 24
 stalling on hill 25
 traversing hillsides 25
 uphill 25

E

engine
 break-in 22
 starting 23
engine oil
 capacity 46
 recommended 46

F

fluids
 capacities 46
 recommended 46
fuel
 add 22
 gauge 17
 handling guidelines 13
 specifications 22
 tank cap 19

G

gasoline, see fuel
glove box 19

H

hauling, vehicle 60
headlights 50
horn switch 17

I

initial service items 44

K

key switch 17

L

labels, safety 9
lifting, vehicle 15, 47
low oil pressure indicator 17
lubricants, recommended 46

M

maintenance
 chart 44
 fluid capacities 46
 recommended fluids and lubricants 46
 scheduled 43
 winch 30
malfunction indicator light (MIL) 57

N

neutral lock 61

O

oil, engine
 capacity 46
 recommended 46
operator safety 11

P

parking brake, hydraulic 18
parking brake, mechanical 18

INDEX

PIN plate 8
pre-ride inspection 21

R

registration information, vehicle 7

S

safety
carbon monoxide 13
cargo 11
driving downhill 14
driving in reverse 14
driving uphill 14
driving with passenger 13
engine exhaust 13
fuel 13
hot exhaust 15
labels 9
lifting, vehicle 15, 47
operation 21
operator 11
pre-ride inspection 21
slippery terrain 14
stalling 14
tire pressure 11, 49
tires 14
unauthorized use 12
vehicle modification 15
weight capacity 11
winch 27

safety symbols 7
scheduled maintenance chart 44
seat bottom 19
serial number labels 8
shock loading, winch 30
slippery surfaces 24
spark plugs 56
specifications, vehicle 63
steering wheel 18
storage compartments 19
switches
horn 17
key 17

T

tires 48
pressure 11, 49
repair 49
replacement 49
towing, vehicle 61
transporting the vehicle 60

U

USB port 17

V

vehicle
hauling 60
removing from storage 62
specifications 63
storage 61
towing 61
transporting 60
vehicle identification numbers 8

W

warranty information, vehicle 7
washing the vehicle 48
weight capacity, maximum 11
wheels 49, 50
axle and wheel nut torques 49
wheel installation 50
wheel removal 49

winch
cable care 30
maintenance 30
operation 28
safety 27
shock loading 30

Normal use, age, and wear on vehicle components can affect the safe operation and reliability of the vehicle. The recommended inspection and maintenance procedures are crucial for safety, performance, reliability and maximum longevity of your vehicle.

A damaged vehicle, or a vehicle that is not functioning properly is dangerous and must not be operated until repairs are made.

NOTICE: Read the following operational warnings before driving the vehicle:

⚠ WARNING

Before exiting the vehicle, turn the key switch to the OFF position and remove the key from the vehicle to prevent unauthorized use.

Drive the vehicle at appropriate speeds for the terrain and conditions. Be aware of any environmental conditions that change the terrain and your ability to control the vehicle.

Do not drive on excessively steep hills. Evaluate the terrain before descending a hill. Drive slowly and deliberately. Use the brake to limit speed and maintain control. Sudden braking or turning can cause a loss of vehicle control. Drive straight down the hill; do not drive across the hill.

Operate in approved areas.

Keep both feet, legs, hands and arms inside the vehicle at all times.

Avoid driving on terrain that is too rough for the capabilities of the vehicle and your driving skills.

Before driving in the reverse direction, make sure the area behind the vehicle is clear. Accelerate slowly and avoid making sharp turns.

Make sure the direction selector is in the correct position before pressing the accelerator pedal.

Decrease speed before and during turns.

Bring the vehicle to a complete stop before moving the direction selector.

See OX 400 - VEHICLE SPECIFICATIONS on page 55 for the vehicle load and seat capacity.

NOTICE: Read the following maintenance information and warnings before servicing or repairing the vehicle:

Follow the procedures and comply with the safety information in this manual while performing vehicle service or maintenance.

Use the tools shown in the tool list and wear the specified safety equipment when performing vehicle service or maintenance.

⚠ WARNING

Remove all jewelry before servicing the vehicle.

Do not allow loose clothing or hair to contact the moving parts.

Do not touch hot objects.

The drive wheels must be lifted and supported on jack stands before performing any service to the powertrain while the motor is in operation.



When servicing the vehicle, always wear eye protection. Be careful when working around batteries, using solvents, or compressed air.

Use insulated wrenches to decrease the risk of a short-circuit if a wrench contacts the battery terminals. A short-circuit in a battery can cause an explosion.

To prevent the risk of battery explosion, keep all flammable materials, open flames, or sparks away from the batteries.

Hydrogen gas is produced during the charging cycle. Charge the batteries only well ventilated areas.

Maintain constant awareness that some components are heavy, spring loaded, corrosive, explosive, can cause high amperage, or get extremely hot. Keep your hands, face, feet and body away from any area that can expose them to injury if an unexpected situation occurs.

MANUFACTURER INFORMATION

Textron Specialized Vehicles
1451 Marvin Griffin Road
Augusta, Georgia 30906 - 3852
USA

Consumer: 877-394-6727

www.trackeroffroad.com

California Proposition 65



WARNING

The Engine Exhaust from this product contains chemicals known to the State of California to cause cancer, birth defects or other reproductive harm.

Service manuals are available at www.trackeroffroad.com.

Copyrighted Material

This manual may not be reproduced in whole or in part without the express permission of the manufacturer.